

RET-413-PAR30-FIX

Fixed Recessed Hardwire Remote Transformer

Project Name:		Type:	
Catalog Number:		Date:	

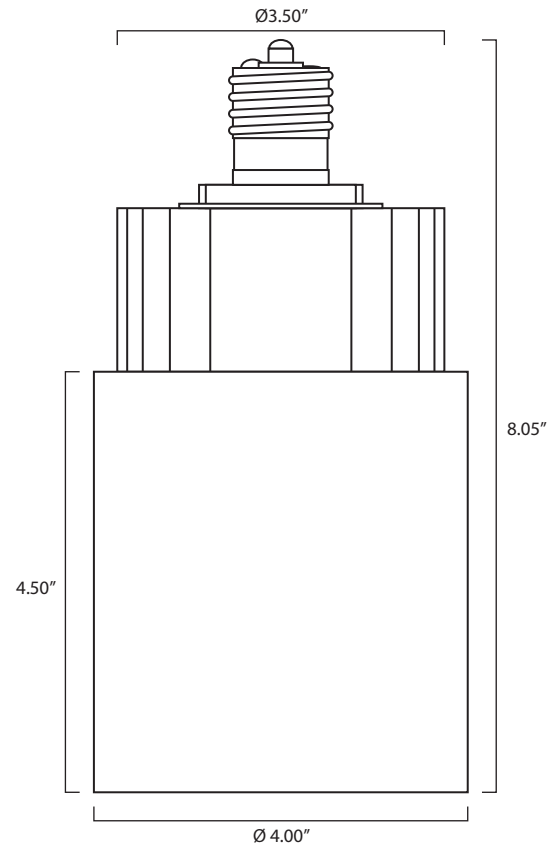

Can be Used for Multiple/Slot Application

**Key Features**

- Easily upgrade existing fixtures
- No disruption to ceiling
- Replace existing CMH or Halogen optics
- Replace continuous slot optics
- Universal 5/8" threaded nipple mount
- New optic mounts into same mounting hole
- Remote LED Driver
- Double jointed adjustable bracket
- **See Page 3 for additional mounting options**

LED Source Details

- CREE XML2 LED maximum rating 3,000 mA
- Fixture operating milliamps = 700 mA – 1,400 mA
 - Operating 23% to 47% of rated value
 - Fixture Delivered Lumens = 3500 lumens

RET-413-PAR30-FIX

Fixed Recessed Hardwire Remote Transformer

Project Name:		Type:	
Catalog Number:		Date:	

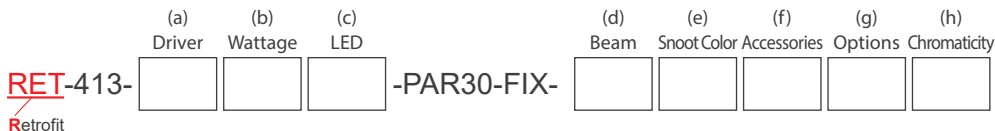

(a) Driver Options

- E = ON/OFF (Electronic)
- D* = MLV .01% Dimming (2 wire)
- ED = Electronic Reverse Phase Dimming 1% (2 wire)
- 0-10V1 = 0-10V 1% Dimming (3 wire)
- DL = Hi-Lume 1% (2 wire) 120V (LTE series)
- RDM DMX = 16 Bit, 4 Channel (2 wire with CAT5 - Hardwire)

*MLV power supply is intended for use with forward phase SCR or Triac dimmers. Do not use with relays or toggle switches, do not use with reverse phase dimmers.

(b) Wattage Options

- 11W = ON/OFF
- 18W = MLV <1% Dimming
- 22W = ON/OFF
- 28W = MLV <1% Dimming
- 33W = ON/OFF, 0-10V 1%
- 42W = MLV <1% Dimming
- 44W = ON/OFF, 0-10V 1%
- 48W = Lutron
- 55W = ON/OFF, DMX

(c) LED Type Options

- XLED = Cree XPL2 LED @ All Wattages







(d) Beam Options

- NSP = Narrow Spot
- SP = Spot
- NFL = Narrow Flood
- FL = Flood

(e) Snoot Color Options

- BLKS = Black Snoot
- WHTS = White Snoot
- PWTS = Pewter Snoot

(f) Optical and Accessory Options

- LS = Lens Softener - +20% increase in beam width. Shields optical face visually. Softens edges of beam. 
- LSL = Linear Spread Lens - Horizontal or vertical beam elongation. 
- WFL = Wide Flood Lens - Wall washing increases the beam by 50% width with elimination of center beam. 
- LV = Louver - Small black hexcel louver eliminates all surface brightness. Creates stronger vertical cut off with -20% beam width. 
- CHL = Cross Hiar Louver 
- H = Halogen - 100K warmer. 2700k to 2500K 
- DH = Dimmed Halogen - 400K warmer. 2700k to 2300K 

(g) Options

- 120V = 120VAC 60Hz (Standard)
- 230V = 230VAC 50Hz (Used in conjunction with 230V track)
- 277V = 277VAC 60Hz (Used in conjunction with 277V track)
- 120/277V = 120/277VAC 60Hz
- 347V = 347VAC 60Hz
- HWD = Hardwire
- SCR = Screw-in (RET only)
- 56R30 = PAR56 to CPAR30 Reducer
- 64R30 = PAR64 to CPAR30 Reducer
- 80+ = CRI over 80
- 90+ = CRI over 90
- DMX* = .39% to 100%, 1200 milliamp constant voltage LED driver, dip switch addressable, 3 channel for 27K & 30K, 4 channel for RGBW, CAT5 in & out*

*DMX is required in RGBW or in any 2 circuits or more. Custom colors available - Consult factory for more details.

(h) Color Temperature Options

- | White LED | Colored/Themed LED |
|--|--------------------------------------|
| 22K* = 2200 Kelvin (candlelight color) | UV275** = 275 NM UV virus sterilizer |
| 27K = 2700 Kelvin (incandescent color) | UV365*** = 365 NM UV black light |
| 30K = 3000 Kelvin (halogen color) | UV390*** = 390 NM UV black light |
| 35K = 3500 Kelvin (warm incandescent) | Blue*** = 465 - 485 NM wavelength |
| 40K = 4000 Kelvin (cool incandescent) | Green*** = 520 - 535 NM wavelength |
| 50K = 5000 Kelvin (day white) | Amber*** = 585 - 595NM wavelength |
| 65K = 6500 Kelvin (12 noon sunlight) | Red*** = 620 - 630 NM wavelength |
| | RGBW3K**** = Red, Green, Blue, White |
| | RGBW4K**** = Red, Green, Blue, White |

*1050 mA or less

**500 mA

***700 mA

****Must utilize DMX @ 700 mA

RET-413-PAR30-FIX

Fixed Recessed Hardwire Remote Transformer

Project Name:		Type:	
Catalog Number:		Date:	

On/Off Driver Used for: up to 42W

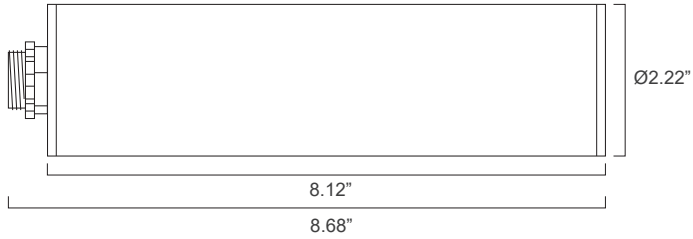

55W Driver

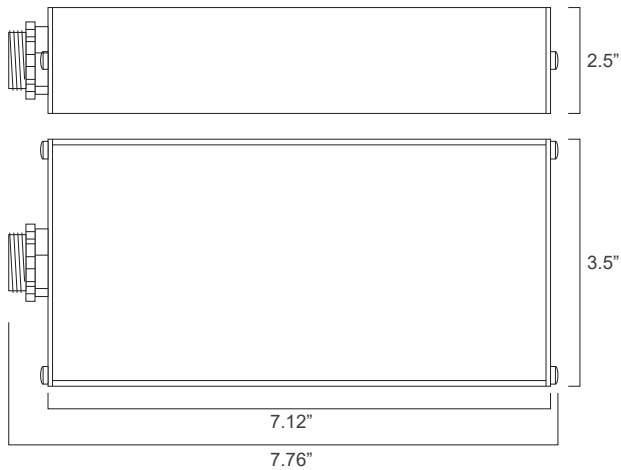
**Electrical**

- Optional - 12V AC remote class 2
- 100V, 120V, 230V, 277V or 347V

LED

- 3,000mA maximum rated CREE XPL2 LED
- Operates between 450 to 1200mA
- 15% to 40% of rated mA

LED Driver

- D – 2 wire forward phase .01% LED driver fade to off glow to on
- ED – 2 wire reverse phase 1% LED driver
- DC – 12V or 24V

Optics

- TIR discrete injection molded polycarbonate precision LED optic
- 45-degree vertical cut off

Installation

- IPS Nipple - Unistrut (Not provided)

Certification

- UL Damp Listed – IP 52

Warranty

- 5 Year – ED, 0-10V, DMX and colored LED fixtures
- 7 Year – D and White LED fixtures

RET-413-PAR30-FIX

Fixed Recessed Hardwire Remote Transformer

Project Name:		Type:	
Catalog Number:		Date:	

Wattage & Lumen Output

700 Milliamps - 1800 Lumens 22W	1000 Milliamps - 2500 Lumens 33W	1200 Milliamps - 3100 Lumens 42W	1400 Milliamps - 3400 Lumens 46W	1600 Milliamps - 3900 Lumens 55W
---	--	--	--	--

3 Step CREE XPL2 LED

Kelvin-CRI	Multiplier
27K-80+ CRI	1
27K-90+ CRI	0.80
30K-80+ CRI	1
30K-90+ CRI	0.85
35K-80+ CRI	1.05
35K-90+ CRI	0.9
40K-80+ CRI	1.09
50K-80+ CRI	1.09
65K-80+ CRI	1.05
80+ = 84 CRI	
90+ = 94 CRI	

Spot 19°

4'	1,370 fc	1.4'
6'	609 fc	2.1'
8'	342 fc	2.8'
10'	219 fc	3.5'
12'	152 fc	4.2'
20'	55 fc	7.0'
26.7'	31 fc	9.4'
40'	14 fc	14.0'

55W PAR30 - 3,607 lm

Narrow Spot 12°

2'	11,097 fc	0.4'
4'	2,774 fc	0.9'
6'	1,233 fc	1.3'
8'	694 fc	1.7'
10'	444 fc	2.1'
12'	308 fc	2.6'

55W PAR30 - 3,372 lm

Narrow Flood 22°

4'	1,192 fc	1.5'
6'	530 fc	2.2'
8'	298 fc	2.9'
10'	191 fc	3.6'
12'	132 fc	4.4'
20'	48 fc	7.3'
26.7'	27 fc	9.7'
40'	12 fc	14.5'

55W PAR30 - 3,481 lm

Flood 32°

4'	403 fc	2.3'
6'	179 fc	3.4'
8'	101 fc	4.5'
10'	65 fc	5.7'
12'	45 fc	6.8'
20'	16 fc	11.3'
26.7'	9 fc	15.1'
40'	4 fc	22.7'

55W PAR30 - 3,245 lm

Intensity Summary (cd)

Gamma	All Planes	Flux (lm)
0	44389	
5	27240	1963
10	9044	
15	2798	872
20	854	
25	440	214
30	285	
35	211	135
40	172	
45	133	105
50	102	
55	57	56
60	45	
65	29	25
70	3	
75	1	1
80	1	
85	0	0
90	0	

Intensity Summary (cd)

Gamma	All Planes	Flux (lm)
0	19074	
5	16233	1332
10	9848	
15	5190	1461
20	2626	
25	1289	620
30	632	
35	329	220
40	211	
45	146	114
50	98	
55	57	55
60	42	
65	27	26
70	14	
75	9	10
80	6	
85	2	3
90	0	

Intensity Summary (cd)

Gamma	All Planes	Flux (lm)
0	6451	
5	5949	529
10	4754	
15	3424	944
20	2326	
25	1552	720
30	1033	
35	639	405
40	368	
45	227	181
50	145	
55	88	83
60	58	
65	39	39
70	21	
75	14	15
80	9	
85	4	4
90	0	

Zonal Flux and Percentages

Zone	Flux (lm)	%Luminaire
0-30	3049	90.4
0-40	3784	94.4
0-60	3345	99.2
0-90	3372	100.0
40-90	188	5.6
60-90	27	0.8
90-180	0	0.0
0-180	3372	100.0

Zonal Flux and Percentages

Zone	Flux (lm)	%Luminaire
0-30	3413	88.8
0-40	3633	94.6
0-60	3802	99.0
0-90	3840	100.0
40-90	208	5.4
60-90	39	1.0
90-180	0	0.0
0-180	3841	100.0

Zonal Flux and Percentages

Zone	Flux (lm)	%Luminaire
0-30	2193	75.1
0-40	2598	89.0
0-60	2862	98.0
0-90	2919	100.0
40-90	321	11.0
60-90	58	2.0
90-180	0	0.0
0-180	2919	100.0

All planes - Solid (cd)

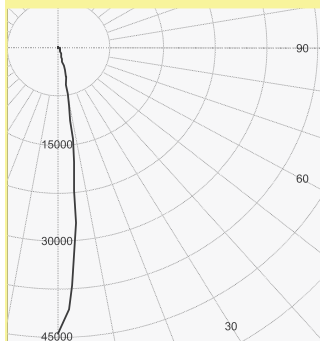

All planes - Solid (cd)

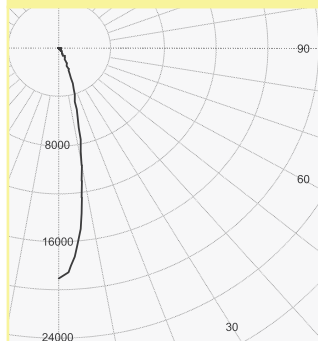

All planes - Solid (cd)

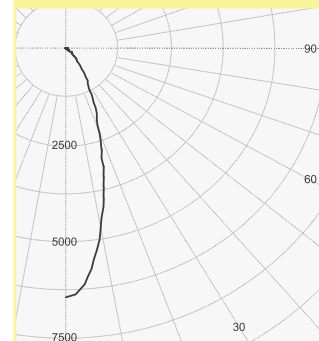

RET-413-PAR30-FIX

Fixed Recessed Hardwire Remote Transformer

Project Name:		Type:	
Catalog Number:		Date:	

Clarté Lighting 3000K 80+ CRI Color Metrics

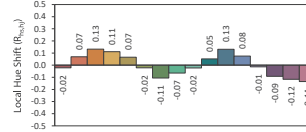
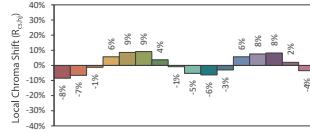
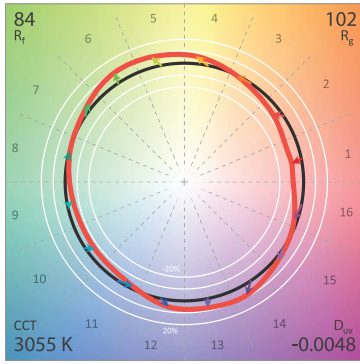

CIE 13.3-1995 (CRI)
R_a 86
R_g 29

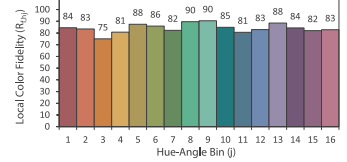
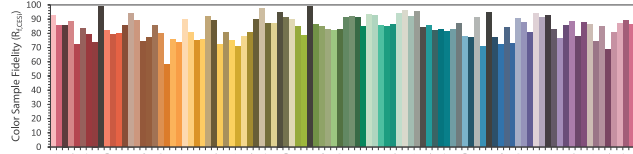

Clarté Lighting 3000K 90+ CRI Color Metrics

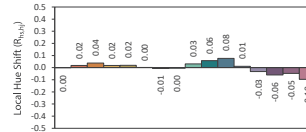
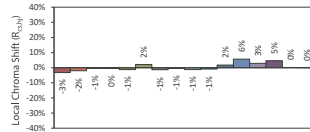
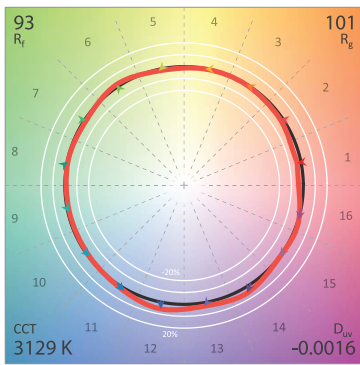

CIE 13.3-1995 (CRI)
R_a 95
R_g 74

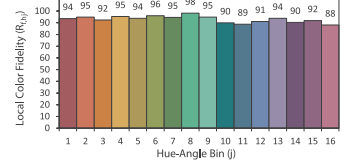
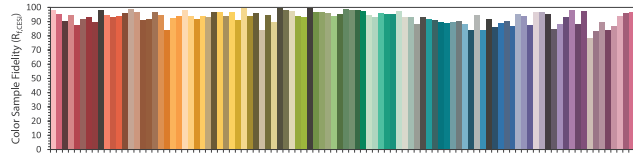

Clarté Lighting 3000K 90+ CRI Halogen Lens (H) Color Metrics

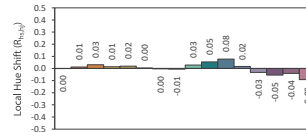
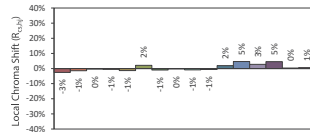
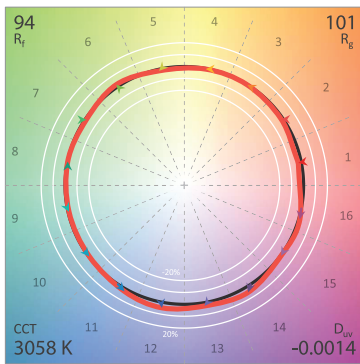

CIE 13.3-1995 (CRI)
R_a 96
R_g 79

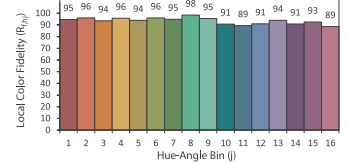
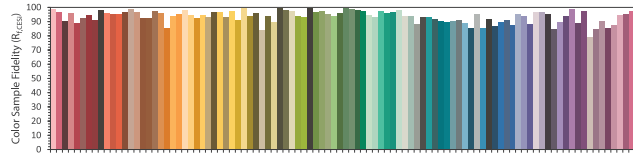

Clarté Lighting 3000K 90+ CRI Dimmed Halogen Lens (DH) Color Metrics

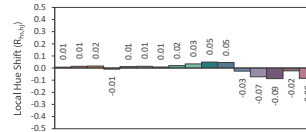
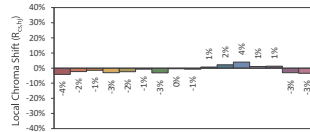
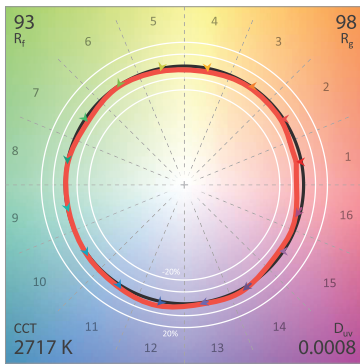

CIE 13.3-1995 (CRI)
R_a 95
R_g 64

