

MR3-635-PAR20

Multiple Round 3-Light Slot

| | | | |
|-----------------|--|-------|--|
| Project Name: | | Type: | |
| Catalog Number: | | Date: | |

Trim



Trimless

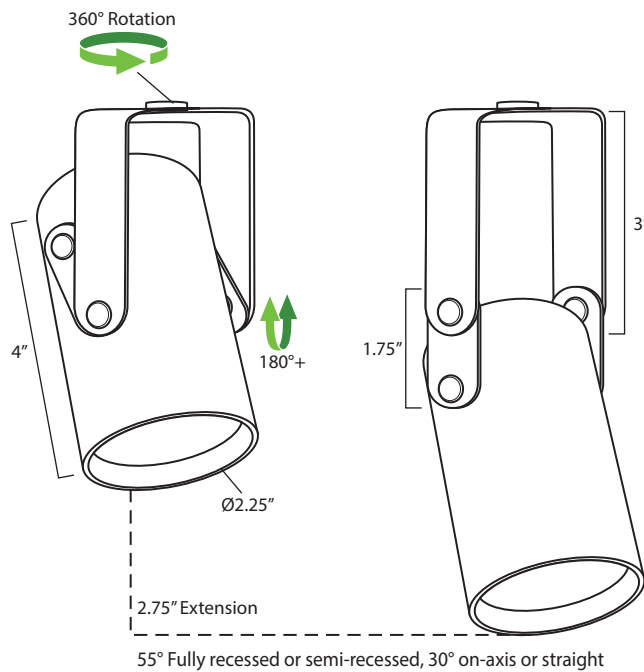

Key Features

- Fully recessed or semi recessed PAR20 optic orientation
- 2 circuits - circuit for each optical array
- Remote Transformer Option
- Up to 4 architectural accessories per optic
- Over 3300+ Custom color finish options
- 100,000+ L70 life
- 7 Year Warranty – White LED

LED Source Details

- CREE XPL2 LED maximum rating = 3,000mA
- Fixture operating milliamp range = 700mA to 1200mA.
- Operating 23% to 40% of rated value
- Fixture wattage range = 16W to 28W
- Fixture delivered lumens = 1,200 to 2,000 lumens

Last revised: 04/04/2023

MR3-635-PAR20

Multiple Round 3-Light Slot

| | | | |
|-----------------|--|-------|--|
| Project Name: | | Type: | |
| Catalog Number: | | Date: | |

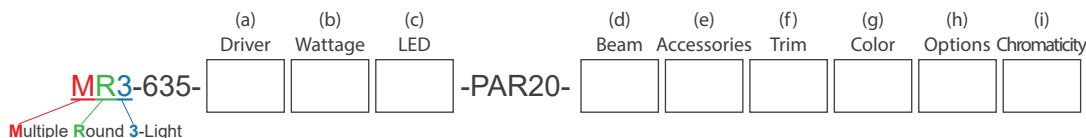

(a) Driver Options

- E = ON/OFF (Electronic)
- D = MLV 1% Dimming (2 wire)
- DC12V = .01% PWM DC dimming (2 wire)
- DC24V = .01% PWM DC dimming (2 wire)
- ED = Electronic Reverse Phase Dimming 1% (2 wire)
- 0-10V1 = 0-10V 1% Dimming (4 wire)
- DALI2 = .01% Digital Addressable Lighting Interface V2
- DALI2-4 = .01% Digital Addressable Lighting Interface V2 (4 fixtures)
- RDM DMX = 16 Bit, 4 Channel (2 wire with CAT5)
- ABS = Absolute Light .001% Dimming (use with RGBW)
- ABSX = DMX Absolute Light .001% RGBW dimming

(b) Wattage Options

- 16W (1200 Lumens) = ON/OFF
- 18W (1200 Lumens) = MLV <1% Dimming
- 24W (1800 Lumens) = ON/OFF
- 28W (2000 Lumens) = MLV <1% Dimming, ON/OFF, 0-10V 1%, Lutron, DMX







(c) LED Type Options

- XLED = Cree XPL2 LED @ All Wattages

(d) Beam Options

- NSP = Narrow Spot NFL = Narrow Flood
- SP = Spot FL = Flood

(e) Optical and Accessory Options

- LS = Lens Softener - +20% increase in beam width. Shields optical face visually. Softens edges of beam. 
- LSL = Linear Spread Lens - Horizontal or vertical beam elongation. 
- WFL = Wide Flood Lens - Wall washing increases the beam by 50% width with elimination of center beam. 
- LV = Louver - Hexcel louver eliminates all surface brightness. Creates stronger vertical cut off with -20% beam width. 
- CHL = Cross Hair Louver 
- H = Halogen - 150K warmer. 2700k to 2550K 
- DH = Dimmed Halogen - 300K warmer. 2700k to 2400K 

(f) Trim Type

- T = Trimmed (for suspended ceiling, T-bar, or plaster ceiling installation)
- TL = Trimless (for wood frame plaster ceiling installation)

(g) Fixture Color Options

- BLK = Black
- WHT = White
- PWT = Pewter
- Select Custom Color (Review Website for Over 3,300 Color Options)

(h) Options

- RMT14 = 14Watt 12V AC MLV Step Down Transformer
- RMT60 = 60Watt 12V AC MLV Step Down Transformer
- RMT150 = 150Watt 12V AC MLV Step Down Transformer
- RMT300 = 300Watt 12V AC MLV Step Down Transformer
- 12V = DC
- 24V = DC
- 120V = 120VAC 60Hz (Standard)
- 230V = 230VAC 50Hz
- 277V = 277VAC 60Hz
- 347V = 347VAC 60Hz
- EMG = 90min Emergency Back-Up Battery
- TB = DMX 5-pin Plug-in Terminal Block
- RMT = Remote transformer with remodel trim
- 80+ = CRI over 80
- 90+ = CRI over 90

*Eliminate the need to install new 12V AC step down transformer, Clarté LED trim installs like changing a lamp.

(i) Color Temperature Options

- | | |
|--|--------------------------------------|
| White LED | Colored/Themed LED |
| 22K* = 2200 Kelvin (candlelight color) | UV365*** = 365 NM UV black light |
| 27K = 2700 Kelvin (incandescent color) | UV390*** = 390 NM UV black light |
| 30K = 3000 Kelvin (halogen color) | Blue*** = 465 - 485 NM wavelength |
| 35K = 3500 Kelvin (warm incandescent) | Green*** = 520 - 535 NM wavelength |
| 40K = 4000 Kelvin (cool incandescent) | Amber*** = 585 - 595NM wavelength |
| 50K = 5000 Kelvin (day white) | Red*** = 620 - 630 NM wavelength |
| 65K = 6500 Kelvin (12 noon sunlight) | RGBW3K**** = Red, Green, Blue, White |
| | RGBW4K**** = Red, Green, Blue, White |
| | **500 mA |
| *1050 mA or less | ***700 mA |
| | ****Must utilize DMX @ 700 mA |

MR3-635-PAR20

Multiple Round 3-Light Slot

| | | | |
|-----------------|--|-------|--|
| Project Name: | | Type: | |
| Catalog Number: | | Date: | |

Housing Dimensions:

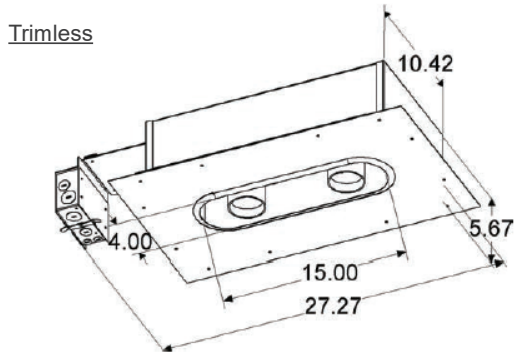
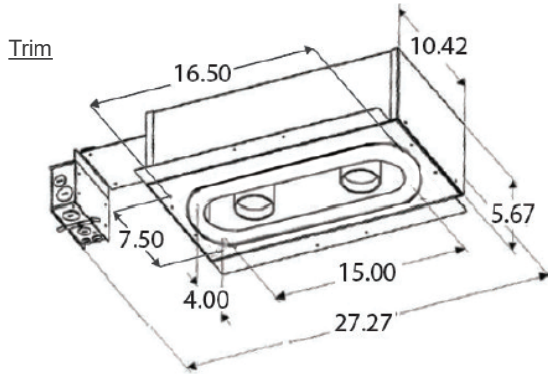

Adjustability: Single bracket praying mantis shown below. Double bracket praying mantis increases adjustability by ~ 20%.

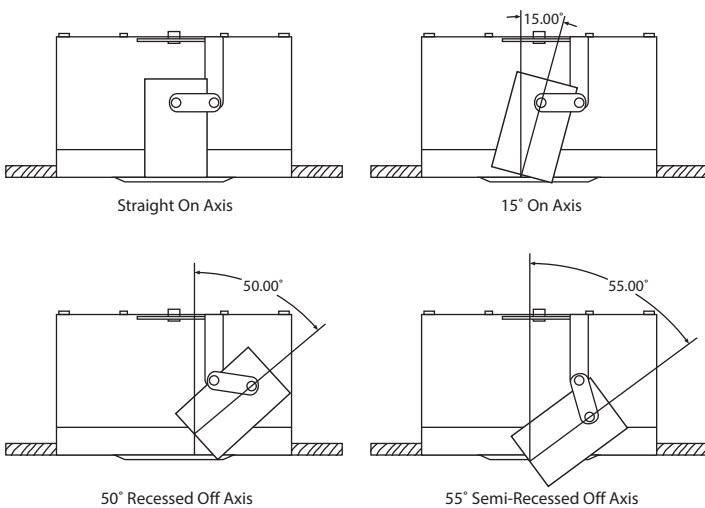

Housing

- 100% aluminum construction
- Single screw removal of 3.375" x 17" top LED driver compartment
- Tool less driver compartment cover for easy access

Electrical

- NON-IC fixture housing
- Optional - 12V AC remote class 2
- Optional - 12V or 24 DC remote class 2
- 100V, 120V, 230V, 277V or 347V

Emergency Battery Back Up

- 190 mA of light output = 6 watts
- LifePO4 battery = up to 10 times life of lead acid batteries
- 90 minute battery back up

LED

- CREE XPL2 LED
- Operates at 1150
- L70 life = 100,000 hr.+

LED Driver

- D – 2 wire forward phase .01% LED driver fade to off glow to on
- ED – 2 wire reverse phase 1% LED driver
- DC – 12V or 24V
- 0-10V – 4 wire 1% LED driver
- Absolute Light – Remote mount class 2 48V din rail .001% LED system
- 16-bit RMD DMX – 65,536 dimming steps fade to off glow to on

Optics

- TIR discrete injection molded polycarbonate precision LED optic
- 45-degree vertical cut off

Trim

- Spring loaded compression installation
- Steal .02" thin trim

Trim Finish

- Textured white, textured black or standard pewter
- 3300+ Custom powder coat finishes optional

Trimless Installation

- Available in trimless

Installation

- Accommodates ceiling thickness up to 2.5"
- Universal adjustable 24" adjustable hangar bars

Certification

- UL Damp Listed – IP 52

Warranty

- 5 Year – ED, 0-10V, DMX and colored LED fixtures
- 7 Year – D and White LED fixtures

2 Trim Installation Options



MR3-635-PAR20

Multiple Round 3-Light Slot

| | | | |
|-----------------|--|-------|--|
| Project Name: | | Type: | |
| Catalog Number: | | Date: | |

| Wattage & Lumen Output | | |
|--|--|-------------------------------------|
| 700/750 Milliamps - 1200 Lumens | 1000/1050 Milliamps - 1800 Lumens | 1200 Milliamps - 2000 Lumens |
| 16W ON/OFF | 24W ON/OFF | 28W MLV <1% Dimming |
| 18W MLV <1% Dimming | 28W MLV <1% Dimming | 28W MLV <1% Dimming |
| | | 0-10V 1% Lutron DMX |

| 3 Step CREE XPL2 LED | |
|----------------------|------------|
| Kelvin-CRI | Multiplier |
| 27K-80+ CRI | 1 |
| 27K-90+ CRI | 0.80 |
| 30K-80+ CRI | 1 |
| 30K-90+ CRI | 0.85 |
| 35K-80+ CRI | 105 |
| 35K-90+ CRI | 0.9 |
| 40K-80+ CRI | 109 |
| 50K-80+ CRI | 109 |
| 65K-80+ CRI | 105 |
| 80+ = 84 CRI | |
| 90+ = 94 CRI | |

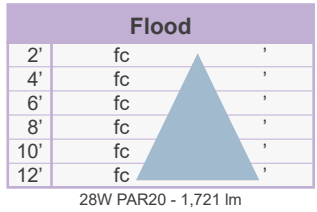
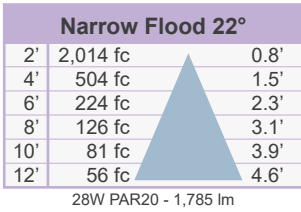
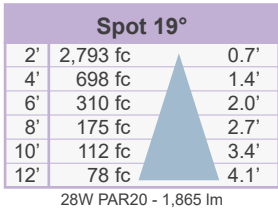
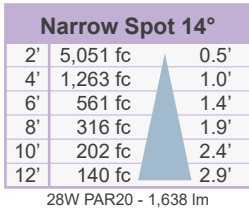

Intensity Summary (cd)

| Gamma | All Planes | Flux (lm) |
|-------|------------|-----------|
| 0 | 20206 | |
| 5 | 13883 | 1000 |
| 10 | 4389 | |
| 15 | 921 | 334 |
| 20 | 336 | |
| 25 | 210 | 99 |
| 30 | 149 | |
| 35 | 117 | 75 |
| 40 | 102 | |
| 45 | 81 | 65 |
| 50 | 73 | |
| 55 | 49 | 47 |
| 60 | 41 | |
| 65 | 15 | 17 |
| 70 | 1 | |
| 75 | 0 | 0 |
| 80 | 0 | |
| 85 | 0 | |
| 90 | 0 | |

Intensity Summary (cd)

| Gamma | All Planes | Flux (lm) |
|-------|------------|-----------|
| 0 | 11174 | |
| 5 | 9332 | 519 |
| 10 | 5281 | |
| 15 | 2307 | 475 |
| 20 | 977 | |
| 25 | 422 | 166 |
| 30 | 220 | |
| 35 | 144 | 71 |
| 40 | 112 | |
| 45 | 92 | 50 |
| 50 | 72 | |
| 55 | 48 | 26 |
| 60 | 41 | |
| 65 | 14 | 5 |
| 70 | 2 | |
| 75 | 1 | 1 |
| 80 | 0 | |
| 85 | 0 | 0 |
| 90 | 0 | |

Intensity Summary (cd)

| Gamma | All Planes | Flux (lm) |
|-------|------------|-----------|
| 0 | 8057 | |
| 5 | 6932 | 579 |
| 10 | 4463 | |
| 15 | 2316 | 650 |
| 20 | 1093 | |
| 25 | 535 | 261 |
| 30 | 300 | |
| 35 | 194 | 126 |
| 40 | 146 | |
| 45 | 118 | 91 |
| 50 | 88 | |
| 55 | 58 | 56 |
| 60 | 50 | |
| 65 | 14 | 20 |
| 70 | 3 | |
| 75 | 1 | 1 |
| 80 | 1 | |
| 85 | 0 | 0 |
| 90 | 0 | |

Intensity Summary (cd)

| Gamma | All Planes | Flux (lm) |
|-------|------------|-----------|
| 0 | 3157 | |
| 5 | 3048 | 281 |
| 10 | 2720 | |
| 15 | 2189 | 597 |
| 20 | 1558 | |
| 25 | 989 | 454 |
| 30 | 564 | |
| 35 | 320 | 207 |
| 40 | 181 | |
| 45 | 105 | 85 |
| 50 | 67 | |
| 55 | 49 | 45 |
| 60 | 39 | |
| 65 | 28 | 28 |
| 70 | 20 | |
| 75 | 17 | 18 |
| 80 | 13 | |
| 85 | 6 | 7 |
| 90 | 0 | |

Zonal Flux and Percentages

| Zone | Flux (lm) | %Luminaire |
|--------|-----------|------------|
| 0-30 | 1433 | 87.5 |
| 0-40 | 1508 | 92.1 |
| 0-60 | 1620 | 98.9 |
| 0-90 | 1638 | 100.0 |
| 40-90 | 130 | 7.9 |
| 60-90 | 18 | 1.1 |
| 90-180 | 0 | 0.0 |
| 0-180 | 1638 | 100.0 |

Zonal Flux and Percentages

| Zone | Flux (lm) | %Luminaire |
|--------|-----------|------------|
| 0-30 | 1635 | 90.6 |
| 0-40 | 1729 | 94.6 |
| 0-60 | 1846 | 99.6 |
| 0-90 | 1865 | 100.0 |
| 40-90 | 136 | 5.4 |
| 60-90 | 19 | 0.4 |
| 90-180 | 0 | 0.0 |
| 0-180 | 1865 | 100.0 |

Zonal Flux and Percentages

| Zone | Flux (lm) | %Luminaire |
|--------|-----------|------------|
| 0-30 | 1490 | 83.5 |
| 0-40 | 1616 | 90.5 |
| 0-60 | 1763 | 98.8 |
| 0-90 | 1785 | 100.0 |
| 40-90 | 169 | 9.5 |
| 60-90 | 22 | 1.2 |
| 90-180 | 0 | 0.0 |
| 0-180 | 1785 | 100.0 |

Zonal Flux and Percentages

| Zone | Flux (lm) | %Luminaire |
|--------|-----------|------------|
| 0-30 | 1332 | 77.4 |
| 0-40 | 1539 | 89.4 |
| 0-60 | 1668 | 96.9 |
| 0-90 | 1721 | 100.0 |
| 40-90 | 182 | 10.6 |
| 60-90 | 53 | 3.1 |
| 90-180 | 0 | 0.0 |
| 0-180 | 1721 | 100.0 |

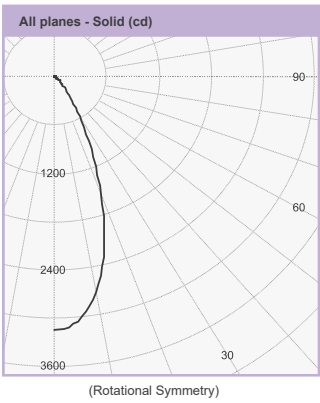
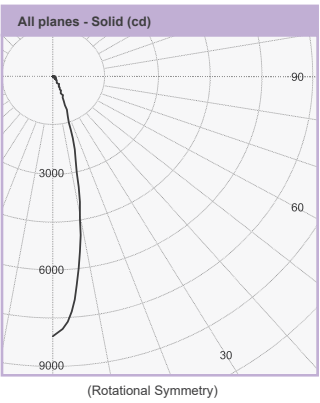
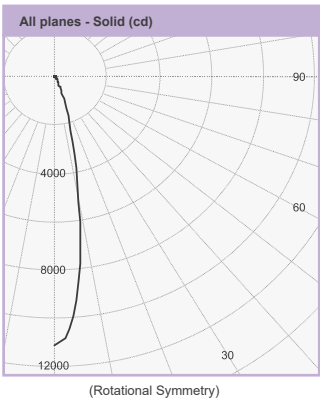
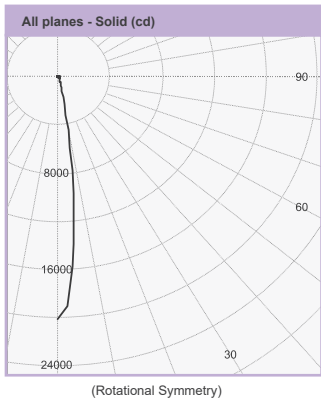

| | | | |
|-----------------|--|-------|--|
| Project Name: | | Type: | |
| Catalog Number: | | Date: | |

Clarté Lighting 3000K 80+ CRI Color Metrics

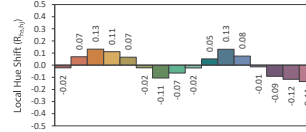
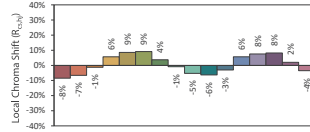
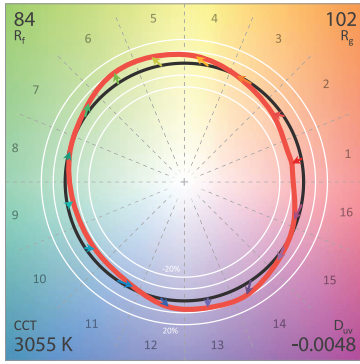

CIE 13.3-1995 (CRI)
 R_a 86
 R_g 29

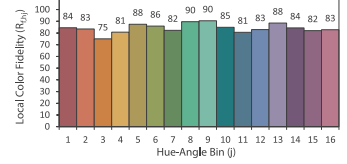
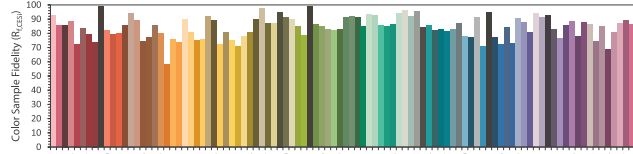

Clarté Lighting 3000K 90+ CRI Color Metrics

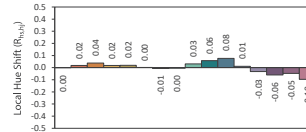
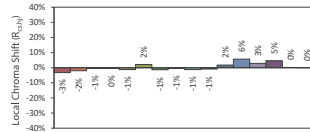
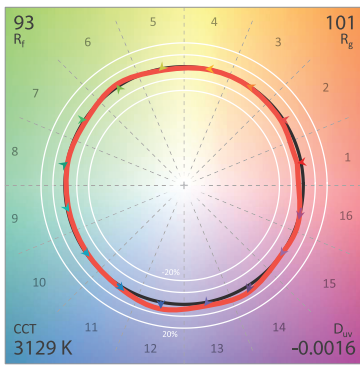

CIE 13.3-1995 (CRI)
 R_a 95
 R_g 74

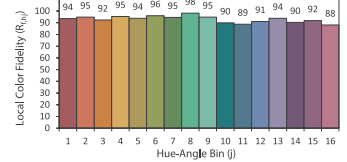
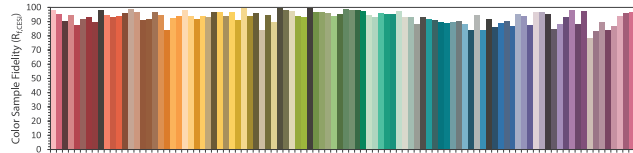

Clarté Lighting 3000K 90+ CRI Halogen Lens (H) Color Metrics

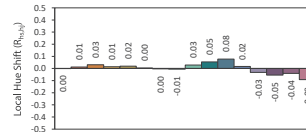
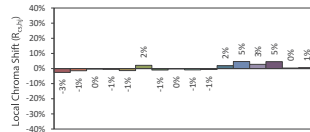
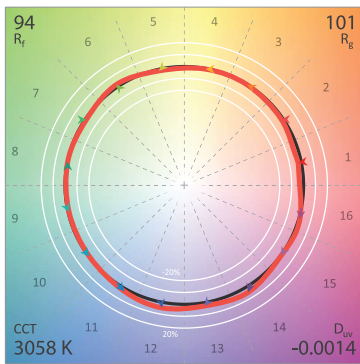

CIE 13.3-1995 (CRI)
 R_a 96
 R_g 79

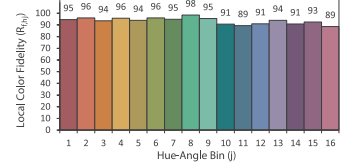
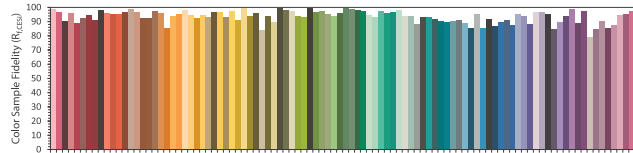

Clarté Lighting 3000K 90+ CRI Dimmed Halogen Lens (DH) Color Metrics

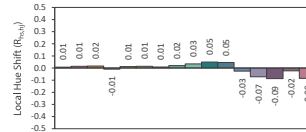
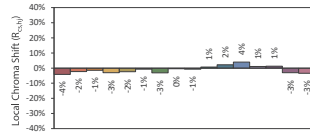
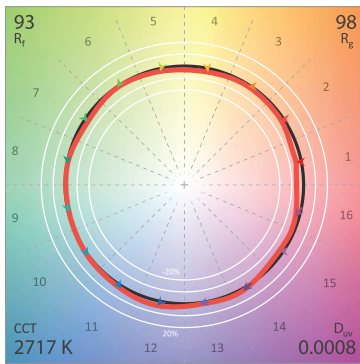

CIE 13.3-1995 (CRI)
 R_a 95
 R_g 64

