

# MS3-628-PAR20

Multiple Square 3-Light Slot

Project Name:		Type:	
Catalog Number:		Date:	

## Trim

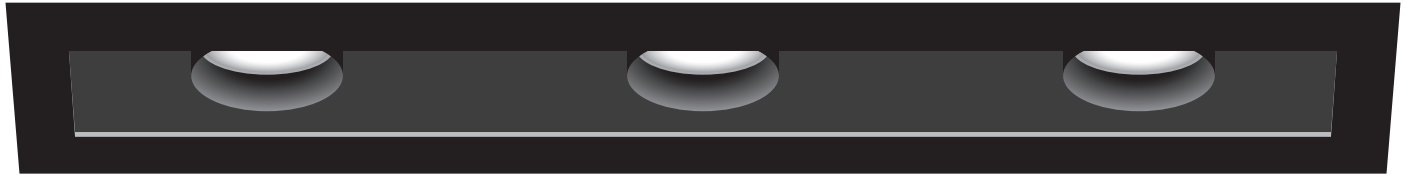

20" x 4" ID - 22.5" x 7.5" OD

## Trimless

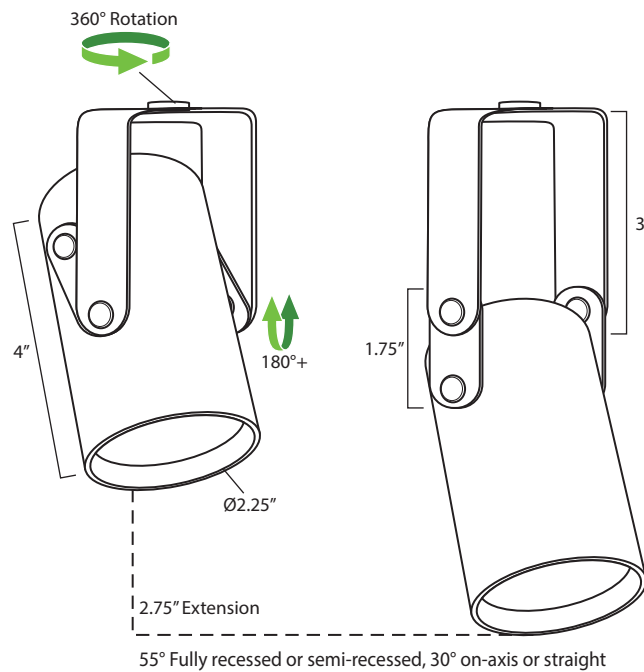

### Key Features

- Fully recessed or semi recessed PAR20 optic orientation
- 2 circuits - circuit for each optical array
- Remote Transformer Optoin
- Up to 4 architectural accessories per optic
- Over 3300+ Custom color finish options
- 100,000+ L70 life
- 7 Year Warranty – White LED

### LED Source Details

- CREE XPL2 LED maximum rating = 3,000mA
- Fixture operating milliamp range = 700mA to 1200mA.
  - Operating 23% to 40% of rated value
  - Fixture wattage range = 16W to 28W
  - Fixture delivered lumens = 1,200 to 2,000 lumens

Last revised: 04/04/2023

# MS3-628-PAR20

Multiple Square 3-Light Slot

Project Name:		Type:	
Catalog Number:		Date:	

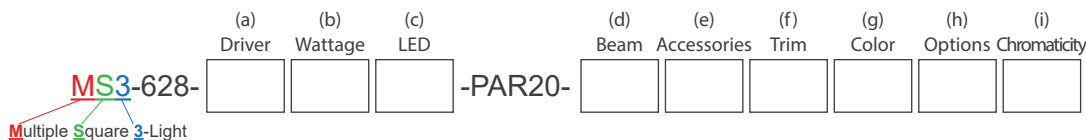

**(a) Driver Options**

- E = ON/OFF (Electronic)
- D = MLV 1% Dimming (2 wire)
- DC12V = .01% PWM DC dimming (2 wire)
- DC24V = .01% PWM DC dimming (2 wire)
- ED = Electronic Reverse Phase Dimming 1% (2 wire)
- 0-10V1 = 0-10V 1% Dimming (4 wire)
- DALI2 = .01% Digital Addressable Lighting Interface V2
- DALI2-4 = .01% Digital Addressable Lighting Interface V2 (4 fixtures)
- RDM DMX = 16 Bit, 4 Channel (2 wire with CAT5)
- ABS = Absolute Light .001% Dimming (use with RGBW)
- ABSX = DMX Absolute Light .001% RGBW dimming

**(b) Wattage Options**

- 16W (1200 Lumens) = ON/OFF
- 18W (1200 Lumens) = MLV <1% Dimming
- 24W (1800 Lumens) = ON/OFF
- 28W (2000 Lumens) = MLV <1% Dimming, ON/OFF, 0-10V 1%, Lutron, DMX





**(c) LED Type Options**

- XLED = Cree XPL2 LED @ All Wattages

**(d) Beam Options**

- NSP = Narrow Spot      NFL = Narrow Flood
- SP = Spot              FL = Flood

**(e) Optical and Accessory Options**

- LS = Lens Softener - +20% increase in beam width. Shields optical face visually. Softens edges of beam. 
- LSL = Linear Spread Lens - Horizontal or vertical beam elongation. 
- WFL = Wide Flood Lens - Wall washing increases the beam by 50% width with elimination of center beam. 
- LV = Louver - Hexcel louver eliminates all surface brightness. Creates stronger vertical cut off with -20% beam width. 
- CHL = Cross Hair Louver 
- H = Halogen - 150K warmer. 2700k to 2550K 
- DH = Dimmed Halogen - 300K warmer. 2700k to 2400K 

**(f) Trim Type**

- T = Trimmed (for suspended ceiling, T-bar, or plaster ceiling installation)
- TL = Trimless (for wood frame plaster ceiling installation)

**(g) Fixture Color Options**

- BLK = Black
- WHT = White
- PWT = Pewter
- Select Custom Color (Review Website for Over 3,300 Color Options)

**(h) Options**

- RMT14 = 14Watt 12V AC MLV Step Down Transformer
- RMT60 = 60Watt 12V AC MLV Step Down Transformer
- RMT150 = 150Watt 12V AC MLV Step Down Transformer
- RMT300 = 300Watt 12V AC MLV Step Down Transformer
- 12V = DC
- 24V = DC
- 120V = 120VAC 60Hz (Standard)
- 230V = 230VAC 50Hz
- 277V = 277VAC 60Hz
- 347V = 347VAC 60Hz
- EMG = 90min Emergency Back-Up Battery
- TB = DMX 5-pin Plug-in Terminal Block
- RMT = Remote transformer with remodel trim
- 80+ = CRI over 80
- 90+ = CRI over 90

\*Eliminate the need to install new 12V AC step down transformer, Clarté LED trim installs like changing a lamp.

**(i) Color Temperature Options**

- |  |                                      |
|--|--------------------------------------|
| <b>White LED</b>                       | <b>Colored/Themed LED</b>            |
| 22K* = 2200 Kelvin (candlelight color) | UV365*** = 365 NM UV black light     |
| 27K = 2700 Kelvin (incandescent color) | UV390*** = 390 NM UV black light     |
| 30K = 3000 Kelvin (halogen color)      | Blue*** = 465 - 485 NM wavelength    |
| 35K = 3500 Kelvin (warm incandescent)  | Green*** = 520 - 535 NM wavelength   |
| 40K = 4000 Kelvin (cool incandescent)  | Amber*** = 585 - 595NM wavelength    |
| 50K = 5000 Kelvin (day white)          | Red*** = 620 - 630 NM wavelength     |
| 65K = 6500 Kelvin (12 noon sunlight)   | RGBW3K**** = Red, Green, Blue, White |
|  | RGBW4K**** = Red, Green, Blue, White |

\*1050 mA or less  
 \*\*500 mA  
 \*\*\*700 mA  
 \*\*\*\*Must utilize DMX @ 700 mA

# MS3-628-PAR20

Multiple Square 3-Light Slot

Project Name:		Type:	
Catalog Number:		Date:	

Housing Dimensions:

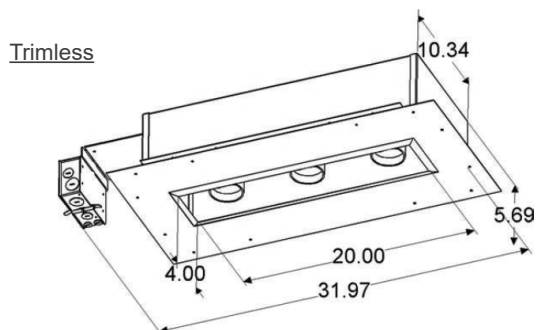
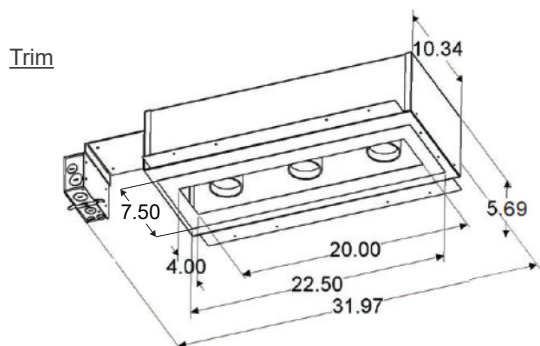

Adjustability: Single bracket praying mantis shown below. Double bracket praying mantis increases adjustability by ~ 20%.

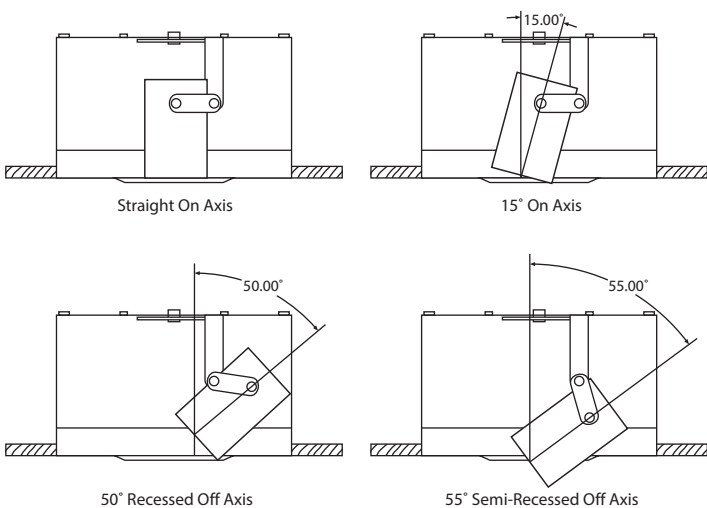

### Housing

- 100% aluminum construction
- Single screw removal of 3.375" x 17" top LED driver compartment
- Tool less driver compartment cover for easy access

### Electrical

- NON-IC fixture housing
- Optional - 12V AC remote class 2
- Optional - 12V or 24 DC remote class 2
- 100V, 120V, 230V, 277V or 347V

### Emergency Battery Back Up

- 190 mA of light output = 6 watts
- LifePO4 battery = up to 10 times life of lead acid batteries
- 90 minute battery back up

### LED

- CREE XPL2 LED
- Operates at 1150
- L70 life = 100,000 hr.+

### LED Driver

- D – 2 wire forward phase .01% LED driver fade to off glow to on
- ED – 2 wire reverse phase 1% LED driver
- DC – 12V or 24V
- 0-10V – 4 wire 1% LED driver
- Absolute Light – Remote mount class 2 48V din rail .001% LED system
- 16-bit RMD DMX – 65,536 dimming steps fade to off glow to on

### Optics

- TIR discrete injection molded polycarbonate precision LED optic
- 45-degree vertical cut off

### Trim

- Spring loaded compression installation
- .02" thin trim

### Trim Finish

- Textured white, textured black or standard pewter
- 3300+ Custom powder coat finishes optional

### Trimless Installation

- Available in trimless

### Installation

- Accommodates ceiling thickness up to 2.5"
- Universal adjustable 24" adjustable hangar bars

### Certification

- UL Damp Listed – IP 52

### Warranty

- 5 Year – ED, 0-10V, DMX and colored LED fixtures
- 7 Year – D and White LED fixtures

### 2 Trim Installation Options



# MS3-628-PAR20

Multiple Square 3-Light Slot

Project Name:		Type:	
Catalog Number:		Date:	

Wattage & Lumen Output		
<b>700/750 Milliamps - 1200 Lumens</b>	<b>1000/1050 Milliamps - 1800 Lumens</b>	<b>1200 Milliamps - 2000 Lumens</b>
16W ON/OFF	24W ON/OFF	28W MLV <1% Dimming
18W MLV <1% Dimming	28W MLV <1% Dimming	28W MLV <1% Dimming
		0-10V 1% Lutron DMX

3 Step CREE XPL2 LED	
Kelvin-CRI	Multiplier
27K-80+ CRI	1
27K-90+ CRI	0.80
30K-80+ CRI	1
30K-90+ CRI	0.85
35K-80+ CRI	105
35K-90+ CRI	0.9
40K-80+ CRI	109
50K-80+ CRI	109
65K-80+ CRI	105
80+ = 84 CRI	
90+ = 94 CRI	

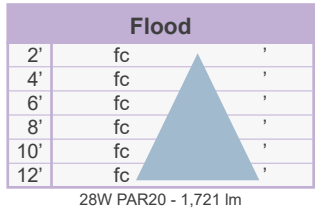
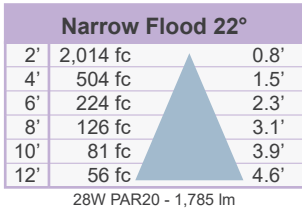
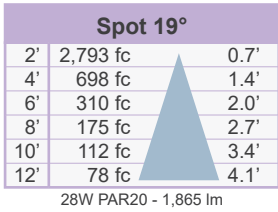
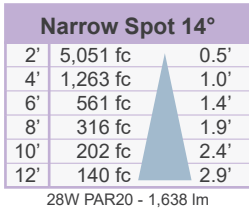

### Intensity Summary (cd)

Gamma	All Planes	Flux (lm)
0	20206	
5	13883	1000
10	4389	
15	921	334
20	336	
25	210	99
30	149	
35	117	75
40	102	
45	81	65
50	73	
55	49	47
60	41	
65	15	17
70	1	
75	0	0
80	0	
85	0	
90	0	

### Intensity Summary (cd)

Gamma	All Planes	Flux (lm)
0	11174	
5	9332	519
10	5281	
15	2307	475
20	977	
25	422	166
30	220	
35	144	71
40	112	
45	92	50
50	72	
55	48	26
60	41	
65	14	5
70	2	
75	1	1
80	0	
85	0	0
90	0	

### Intensity Summary (cd)

Gamma	All Planes	Flux (lm)
0	8057	
5	6932	579
10	4463	
15	2316	650
20	1093	
25	535	261
30	300	
35	194	126
40	146	
45	118	91
50	88	
55	58	56
60	50	
65	14	20
70	3	
75	1	1
80	1	
85	0	0
90	0	

### Intensity Summary (cd)

Gamma	All Planes	Flux (lm)
0	3157	
5	3048	281
10	2720	
15	2189	597
20	1558	
25	989	454
30	564	
35	320	207
40	181	
45	105	85
50	67	
55	49	45
60	39	
65	28	28
70	20	
75	17	18
80	13	
85	6	7
90	0	

### Zonal Flux and Percentages

Zone	Flux (lm)	%Luminaire
0-30	1433	87.5
0-40	1508	92.1
0-60	1620	98.9
0-90	1638	100.0
40-90	130	7.9
60-90	18	1.1
90-180	0	0.0
0-180	1638	100.0

### Zonal Flux and Percentages

Zone	Flux (lm)	%Luminaire
0-30	1635	90.6
0-40	1729	94.6
0-60	1846	99.6
0-90	1865	100.0
40-90	136	5.4
60-90	19	0.4
90-180	0	0.0
0-180	1865	100.0

### Zonal Flux and Percentages

Zone	Flux (lm)	%Luminaire
0-30	1490	83.5
0-40	1616	90.5
0-60	1763	98.8
0-90	1785	100.0
40-90	169	9.5
60-90	22	1.2
90-180	0	0.0
0-180	1785	100.0

### Zonal Flux and Percentages

Zone	Flux (lm)	%Luminaire
0-30	1332	77.4
0-40	1539	89.4
0-60	1668	96.9
0-90	1721	100.0
40-90	182	10.6
60-90	53	3.1
90-180	0	0.0
0-180	1721	100.0

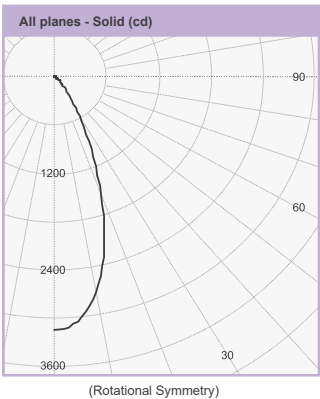
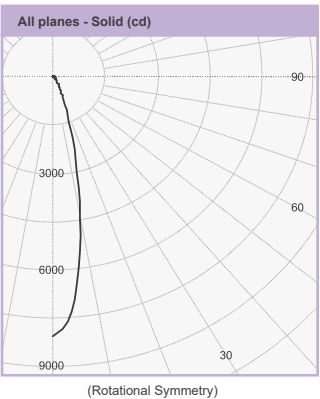
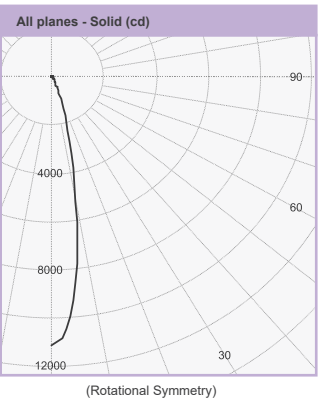
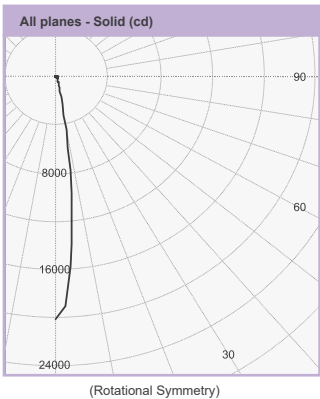

Project Name:		Type:	
Catalog Number:		Date:	

Clarté Lighting 3000K 80+ CRI Color Metrics

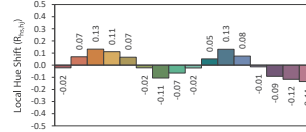
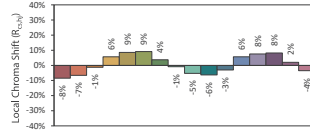
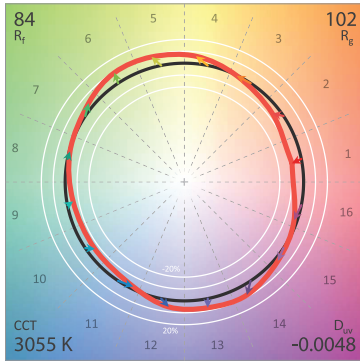

CIE 13.3-1995 (CRI)  
 $R_a$  86  
 $R_g$  29

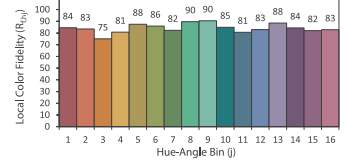
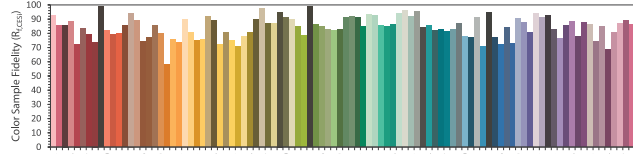

Clarté Lighting 3000K 90+ CRI Color Metrics

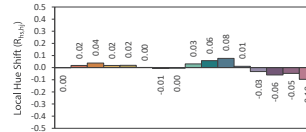
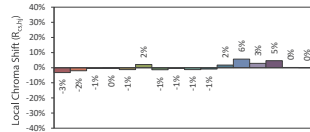
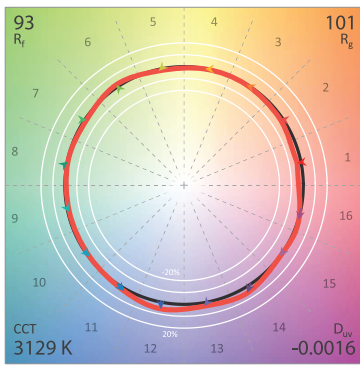

CIE 13.3-1995 (CRI)  
 $R_a$  95  
 $R_g$  74

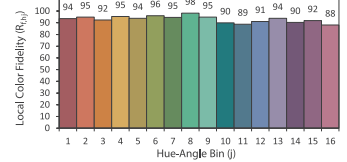
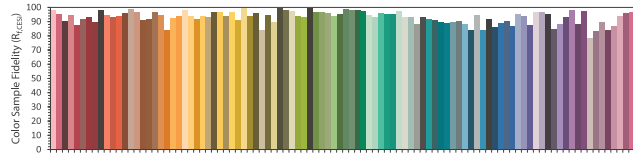

Clarté Lighting 3000K 90+ CRI Halogen Lens (H) Color Metrics

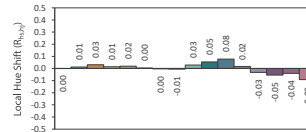
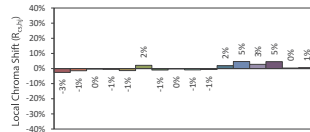
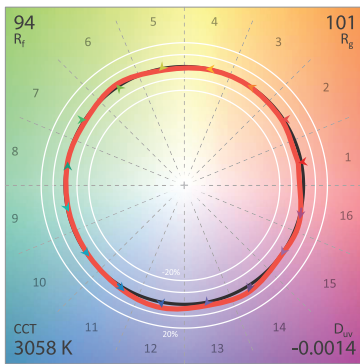

CIE 13.3-1995 (CRI)  
 $R_a$  96  
 $R_g$  79

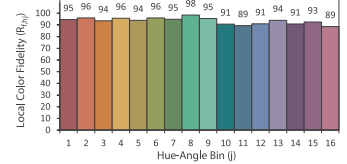
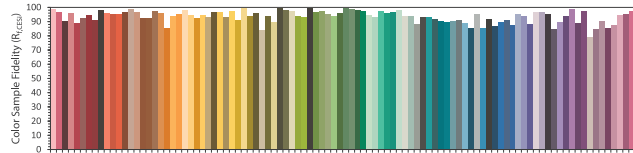

Clarté Lighting 3000K 90+ CRI Dimmed Halogen Lens (DH) Color Metrics

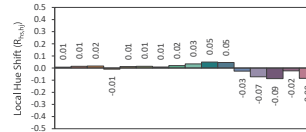
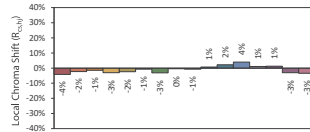
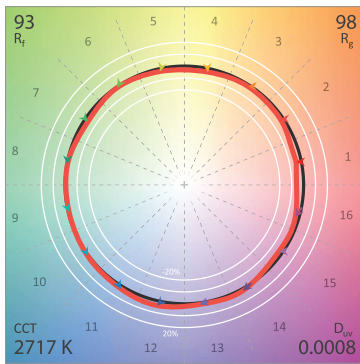

CIE 13.3-1995 (CRI)  
 $R_a$  95  
 $R_g$  64

