

RR1-189-PAR8-X3

Adjustable or Fixed Round 3-Lamp Lipstick Cluster

Project Name:		Type:	
Catalog Number:		Date:	

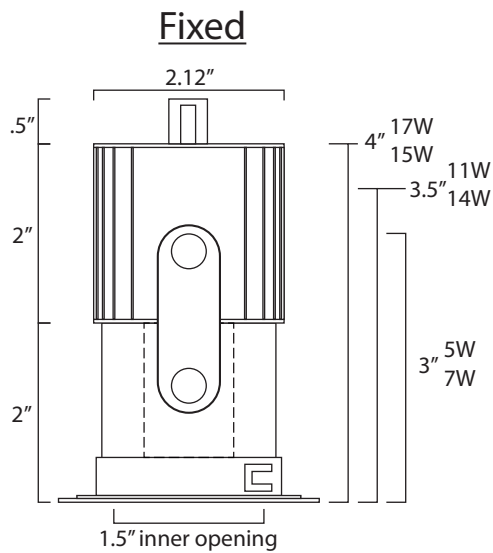
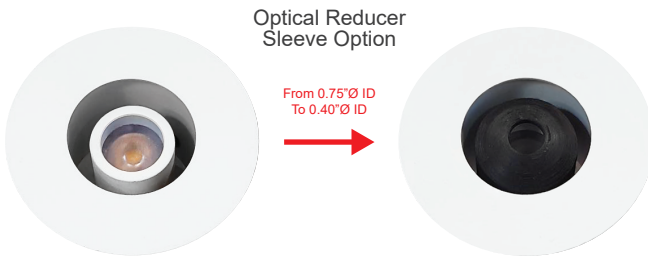
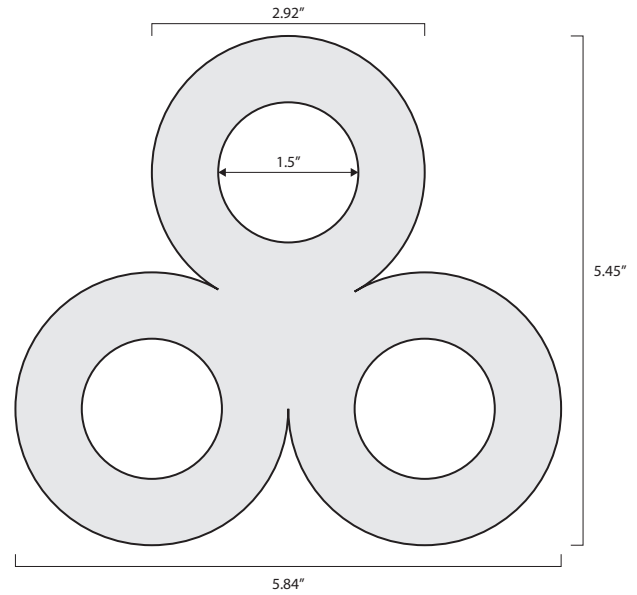
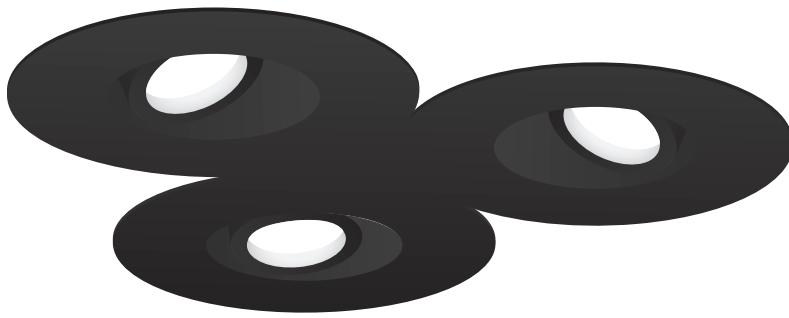

Fixed Wall Wash

Same Dimensions as Fixed

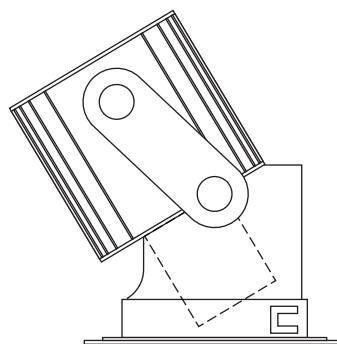

Adjustable

Same Dimensions as Fixed

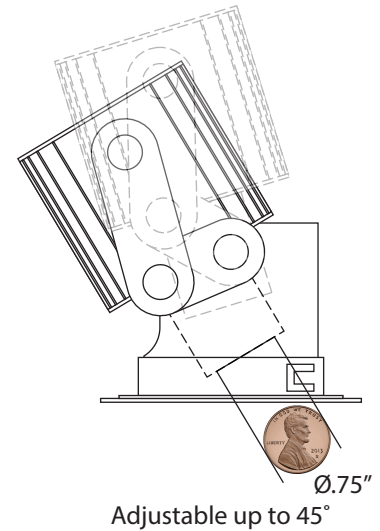

Key Features

- 1.5" ID
- Adjustable up to 50°
- Adjustable Recessed or Semi-Recessed
- Fixed 1/2" Recessed Trimless
- 365° Rotation
- IC or NON IC version
- Remote Transformer Optoin
- .02" Uber Thin Trim Lip
- Over 10,000+ fixture custom color finish options
- 100,000+ L70 life

LED Source Details

- CREE XHP50 LED maximum rating = 1,500mA
- Fixture operating milliamp range = 300mA to 700mA.
- Operating 15% to 38% of rated value 20% to 47%
- Fixture wattage range = 5W to 17W
- Fixture delivered lumens = 500 to 1,150 lumens
- Calculated L70 CREE LED Life – 145,000 hrs*
- Projected L70 CREE LED Life – 315,000 hrs*

*CREE calculated from XHP502 LM80 and TM21 data

Patent No.: US 10,208,928 B1

Last revised: 04/20/2023

RR1-189-PAR8-X3

Adjustable or Fixed Round 3-Lamp Lipstick Cluster

Project Name:		Type:	
Catalog Number:		Date:	

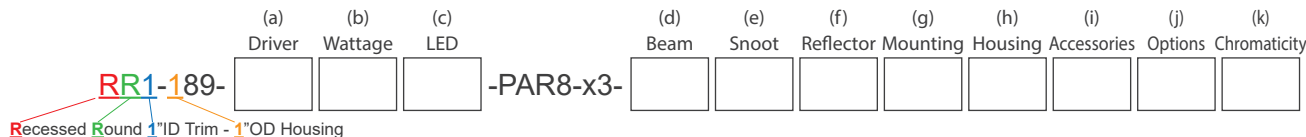

(a) Driver Options

- E = ON/OFF (Electronic)
- D = MLV 1% Dimming (2 wire)
- DC12V = .01% PWM DC dimming (2 wire)
- DC24V = .01% PWM DC dimming (2 wire)
- ED = Electronic Reverse Phase Dimming 1% (2 wire)
- 0-10V1 = 0-10V 1% Dimming (3 wire)
- 0-10V* = Remote mount 4 wire 0-10V LED driver single fixture
- 0-10V 2 = Remote mount 4 wire 0-10V driver for up to 2 fixtures
- 0-10V 3 = Remote mount 4 wire 0-10V driver for up to 3 fixtures
- 0-10V MRI** = 0-10V Dimming with 100bd Filter
- RDM DMX = 16 Bit, 4 Channel (2 wire with CAT5)
- ABS = Absolute Light .001% Dimming (use with RGBW)
- ABSX = DMX Absolute Light .001% RGBW dimming

*Remote single 0-10V LED driver up to 18' away 18ga and 50' away 12ga
 **Operates up to 4 recessed LED light fixtures for MRI room installation with remote LED driver

(b) Wattage Options Per Optic (x3)

- 5W (500 Lumens) = ON/OFF, 0-10V 1%, ED*
- 7W (500 Lumens) = MLV <1% Dimming
- 10W (000 Lumens) = ABS
- 11W (525 Lumens) = ON/OFF, 0-10V 1%, ED*
- 14W (525 Lumens) = MLV <1% Dimming
- 15W (1150 Lumens) = ON/OFF, 0-10V 1%, ED*
- 17W (1150 Lumens) = MLV <1% Dimming, DMX

*Only with no accessories.

(c) Lamp Type Options

X4LED = Cree XHP50 LED = 50+% brighter than XLED
 (available in spot, narrow flood, and flood)

(d) Beam Options

- SP = Spot
- FL = Flood
- NFL = Narrow Flood

(e) Snoot Color Options

- BLKS = Black Snoot
- WHTS = White Snoot
- PWTS = Pewter Snoot

(f) Reflector/Trim Lip Color Options

- WHT/WHT = White Reflector/White Trim Lip
- WHT/BLK = White Reflector/Black Trim Lip
- BLK/BLK = Black Reflector/Black Trim Lip
- BLK/WHT = Black Reflector/White Trim Lip
- PWT/PWT = Pewter Reflector/Pewter Trim Lip
- PWT/WHT = Pewter Reflector/White Trim Lip
- PWT/BLK = Pewter Reflector/Black Trim Lip

(g) Mounting Options

- ADJ = Adjustable
- FX = Fixed
- WOS = Wires Out the Side (reduces height by 0.5")
- FWW = Fixed Wall Wash

(h) Fixture Housing Options

- Non-IC Rated:**
- RMT = No housing, no frame, remote transformer spring clip loaded trim
 - NIC = Frame and junction box to be used with trim version
- IC Rated:**
- AH = 8" x 8" Architectural housing to be used with trimmed or level plane installation

(i) Optical and Accessory Options

- LS = Lens Softener - +20% increase in beam width. Shields optical face visually. Softens edges of beam.
- LSL = Linear Spread Lens - Horizontal or vertical beam elongation.
- WFL = Wide Flood Lens - Wall washing increases the beam by 50% width with elimination of center beam.
- LV = Louver - Small black hexcel louver eliminates all surface brightness. Creates stronger vertical cut off with -20% beam width.
- CHL = Cross Hiar Louver
- H = Halogen - 100K warmer. 2700k to 2500K
- DH = Dimmed Halogen - 400K warmer. 2700k to 2300K

(j) Options

- RMT7 = 7Watt 12V AC MLV Step Down Transformer
- RMT14 = 14Watt 12V AC MLV Step Down Transformer
- RMT17 = 17Watt 12V AC MLV Step Down Transformer
- RMT60 = 60Watt 12V AC MLV Step Down Transformer
- RMT150 = 150Watt 12V AC MLV Step Down Transformer
- RMT300 = 300Watt 12V AC MLV Step Down Transformer
- 12V = DC
- 24V = DC
- 120V = 120VAC 60Hz (Standard)
- 230V = 230VAC 50Hz
- 277V = 277VAC 60Hz
- 347V = 347VAC 60Hz
- EMG = 90min Emergency Back-Up Battery
- TB = DMX 5-pin Plug-in Terminal Block
- RET* = Bi-pin whip to plug Clarté LED trim module into existing MLV transformed recessed halogen MR16 fixtures.
- 80+ = CRI over 80
- 90+ = CRI over 90
- EXT = Exterior zinc primer with zinc infused paint

*Eliminate the need to install new 12V AC step down transformer, Clarté LED trim installs like changing a lamp.

(k) Color Temperature Options

- | | |
|--|-------------------------------------|
| White LED | Colored/Themed LED |
| 22K* = 2200 Kelvin (candlelight color) | UV365** = 365 NM UV black light |
| 27K = 2700 Kelvin (incandescent color) | UV390** = 390 NM UV black light |
| 30K = 3000 Kelvin (halogen color) | Blue* = 465 - 485 NM wavelength |
| 35K = 3500 Kelvin (warm incandescent) | Green* = 520 - 535 NM wavelength |
| 40K = 4000 Kelvin (cool incandescent) | Amber* = 585 - 595NM wavelength |
| 50K = 5000 Kelvin (day white) | Red* = 620 - 630 NM wavelength |
| 65K = 6500 Kelvin (12 noon sunlight) | RGBW3K*** = Red, Green, Blue, White |
| | RGBW4K*** = Red, Green, Blue, White |

*1050 mA or less

**700 mA or less
 ***Must utilize DMX fixture option

RR1-189-PAR8-X3

Adjustable or Fixed Round 3-Lamp Lipstick Cluster

Project Name:		Type:	
Catalog Number:		Date:	

Non-IC: No Housing Remote Transformer Remodel - Trimmed

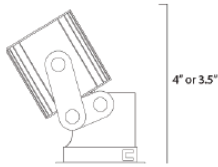

Non-IC: No Housing Framed Fixture with J-Box - Trimmed

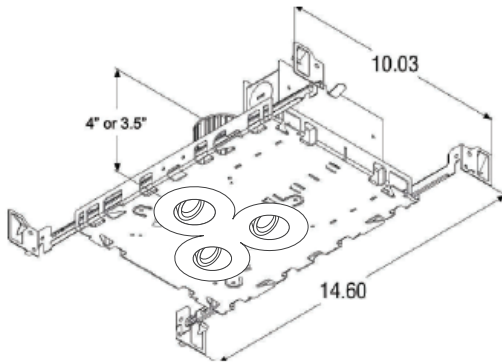

IC: Architectural Housing - Trimless, Level Plane or 1/2" Recessed.

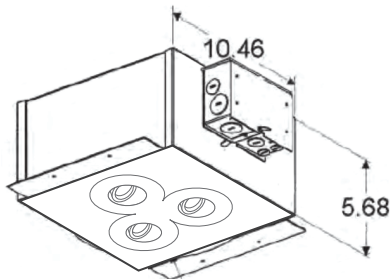
**Housing**

- 100% aluminum construction
- IC housing with hinged 4" x 6" side access panel to j-box & LED driver

Electrical

- IC or NON-IC fixture housing
- Optional - 12V AC remote class 2
- Optional - 12V or 24 DC remote class 2
- 100V, 120V, 230V, 277V or 347V

LED

- 3,000 maximum milliamp rated CREE LED
- Operates between 450 to 1200 milliamps
- L70 life = 100,000 hr.+

LED Driver

- D – 2 wire forward phase .01% LED driver fade to off glow to on
- ED – 2 wire reverse phase 1% LED driver
- DC – 12V or 24V
- 0-10V – 3 wire 1% LED driver
- Absolute Light – Remote mount class 2 48V din rail .001% LED system
- 16-bit RMD DMX – 65,536 dimming steps fade to off glow to on

Optics

- TIR discrete injection molded polycarbonate precision LED optic
- 45-degree vertical cut off

Trim

- .02" thin trim lip
- Hydro form reflector - no spin marks

Trim Finish

- Specular Aluminum Anodized
- Matt Aluminum Anodized
- White, Black or Pewter Powder Coat Paint
- 3300+ Custom Power Coat Paint Colors
- 7000+ Custom Wet Paint Colors

Level Plane and Trimless Installation

- Available in 1/2" recessed trimless, trimless and level plane

Installation

- Accommodates ceiling thickness up to 2.5"
- Universal adjustable 24" adjustable hangar bars

Certification

- UL Damp Listed – IP 52 – Open trim
- UL Wet Listed – IP 65 – Lensed trim

Warranty

- 5 Year – ED, 0-10V, DMX and colored LED fixtures
- 7 Year – D and White LED fixtures

RR1-189-PAR8-X3

Adjustable or Fixed Round 3-Lamp Lipstick Cluster

Project Name:		Type:	
Catalog Number:		Date:	

Wattage & Lumen Output

300 Milliamps - 500 Lumens		700 Milliamps		525 Milliamps - 900 Lumens		700 Milliamps - 1150 Lumens	
5W	ON/OFF 0-10V 1% Dimming ED	10W	Red - Up to 150 Lumens Green - Up to 150 Lumens Blue - Up to 150 Lumens White - Up to 300 Lumens	11W	ON/OFF 0-10V 1% Dimming ED	15W	ON/OFF 0-10V 1% Dimming ED
7W	MLV <1% Dimming			14W	MLV <1% Dimming	14W	MLV <1% Dimming DMX

3 Step CREE XPL2 LED

Kelvin-CRI	Multiplier
27K-80+ CRI	1
27K-90+ CRI	0.80
30K-80+ CRI	1
30K-90+ CRI	0.85
35K-80+ CRI	105
35K-90+ CRI	0.9
40K-80+ CRI	109
50K-80+ CRI	109
65K-80+ CRI	105
80+ = 84 CRI	
90+ = 94 CRI	

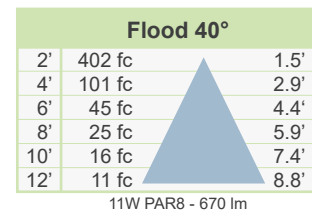
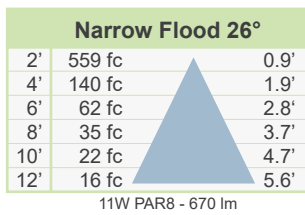

Zonal Flux and Percentages

Zone	%Luminaire
0-20	63
0-30	83.3
0-40	89.8
0-60	95.8
0-80	99.2
0-90	100
10-90	77.9
20-40	26.7
20-50	30.6
40-70	8
60-80	3.4
70-80	1.4
80-90	0.8

Zonal Flux and Percentages

Zone	%Luminaire
0-20	47.3
0-30	74.3
0-40	88.5
0-60	97.5
0-80	99.5
0-90	100
10-90	87.1
20-40	41.2
20-50	48.7
40-70	10.1
60-80	2
70-80	0.9
80-90	0.5

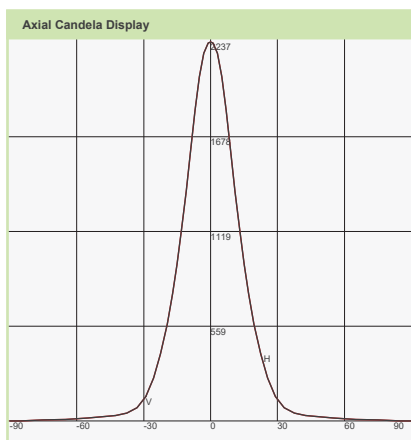

Maximum Candela = 2237 Located At Horizontal Angle = 0, Vertical Angle = 0
H - Horizontal Axial Candela
V - Vertical Axial Candela

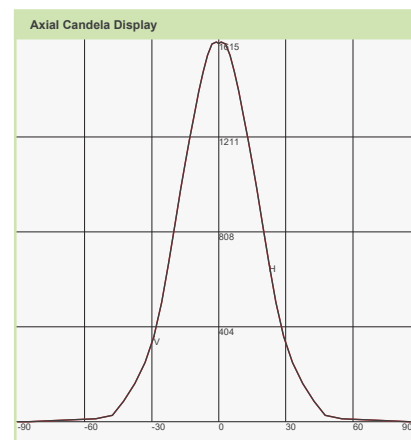

Maximum Candela = 1615 Located At Horizontal Angle = -1, Vertical Angle = 0
H - Horizontal Axial Candela
V - Vertical Axial Candela

Project Name:		Type:	
Catalog Number:		Date:	

Clarté Lighting 3000K 80+ CRI Color Metrics

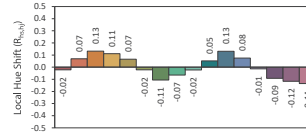
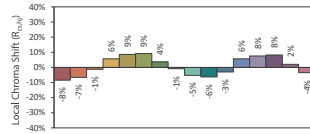
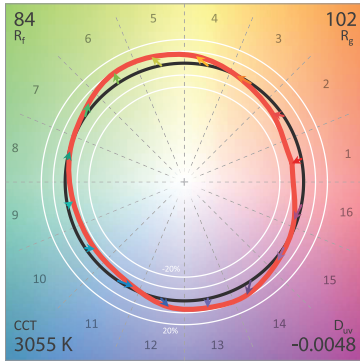

CIE 13.3-1995 (CRI)
R_a 86
R₉ 29

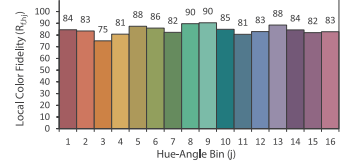
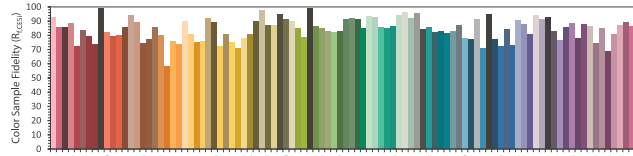

Clarté Lighting 3000K 90+ CRI Color Metrics

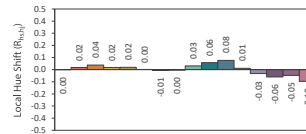
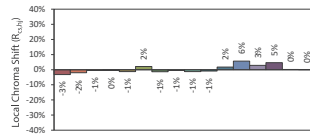
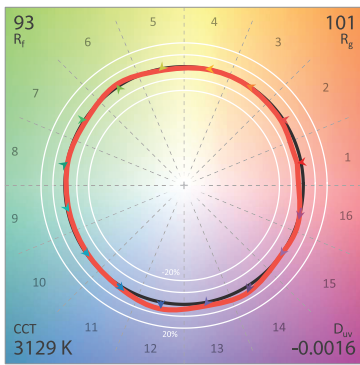

CIE 13.3-1995 (CRI)
R_a 95
R₉ 74

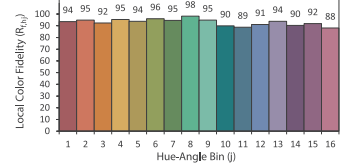
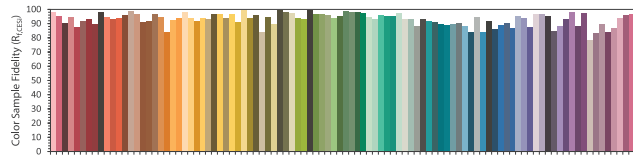

Clarté Lighting 3000K 90+ CRI Halogen Lens (H) Color Metrics

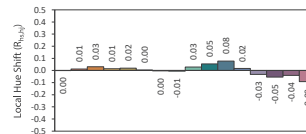
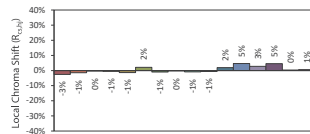
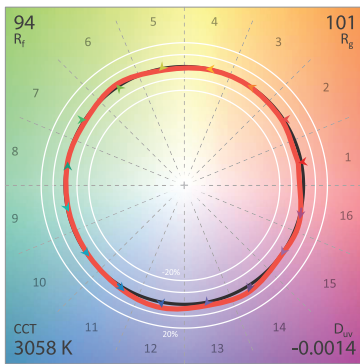

CIE 13.3-1995 (CRI)
R_a 96
R₉ 79

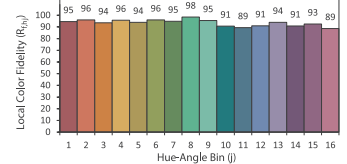
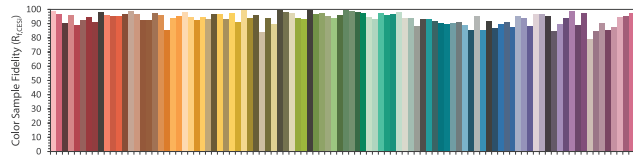

Clarté Lighting 3000K 90+ CRI Dimmed Halogen Lens (DH) Color Metrics

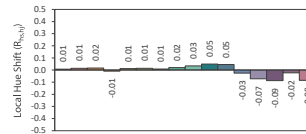
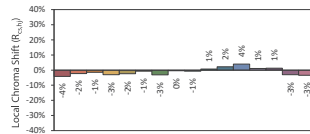
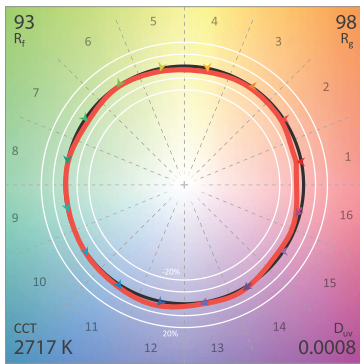

CIE 13.3-1995 (CRI)
R_a 95
R₉ 64

