

SMR1-601-PAR8-FIX

Fixed Mono Point

Project Name:		Type:	
Catalog Number:		Date:	

Canopy Plate



Trimless - Plaster



Trimless - Wood

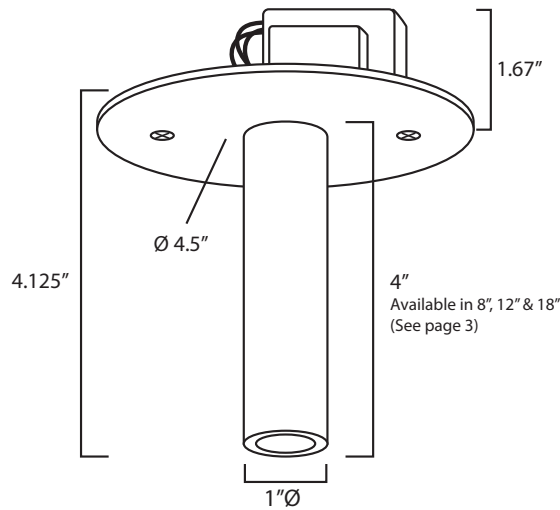

Key Features

- ADA Compliant = 1.625" depth
- ¾" ID & 1" OD LED Optic
- 4 Beam Spreads – Spot (17°), Narrow Flood (26°) or Flood (40°), Luminosity (50° with Vertical Illumination)
- Class 2 = 12V, 24V or 48V
- Accepts Up to 3 Optical Accessories
- UL = IP66 & 1598A (Pending)

LED Source Details

- CREE XHP50.2 LED maximum rating = 1500 mA
- Operating Range = 350 mA to 700 mA
 - Operating 15% to 38% of Rated Value
 - Fixture Wattage Range = 5W to 14W
 - Fixture Delivered Lumens = 450 to 900 Lumens

Patent No.: US 10,208,928 B1
Other Patents Pending

Last revised: 06/13/2023

Project Name:		Type:	
Catalog Number:		Date:	

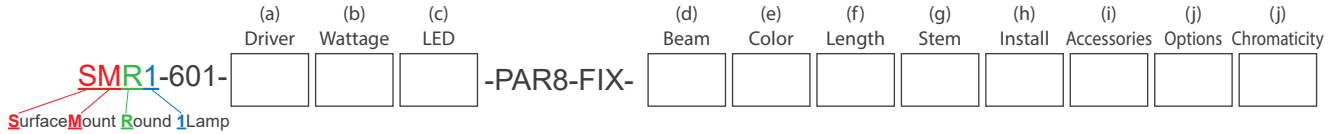

(a) Driver Options

- D = .01% Magnetic Low Voltage Dimming (2 wire)
- ELV = 1% Electronic Low Voltage Dimming
- 12V AC = .01% PWM AC dimming (2 wire) remote magnetic 12V AC transformer
- 24V DC = .01% PWM DC dimming (2 wire) 24V DC power supply
- 0-10V* = Remote mount 4 wire 0-10V LED driver single fixture
- 0-10V 2 = Remote mount 4 wire 0-10V driver for up to 2 fixtures
- 0-10V 3 = Remote mount 4 wire 0-10V driver for up to 3 fixtures
- 0-10V 4** = Remote mount 4 wire 0-10V driver for up to 4 fixtures
- DALI2 = .01% Digital Addressable Lighting Interface V2
- DALI2-4 = .01% Digital Addressable Lighting Interface V2 (4 fixtures)
- RDM DMX = .001% 16 Bit, 4-Channel Dimming (2 wire with CAT5)
- ABS = .001% Absolute Light Dimming (use with RGBW)
- ABSX = DMX Absolute Light .001% RGBW dimming

*Remote single 0-10V LED driver up to 18' away 18ga and 50' away 12ga
 **Remote 0-10V LED driver operates up to 4 fixtures up to 18' away 18ga and 50' away 12ga

(b) Wattage Options

- 5W* = ED, ON/OFF, 0-10V 1% (350 milliamps), 450 lumens
- 7W = MLV <1% Dimming (350 milliamps), 450 lumens
- 10W = Absolute Light
- 11W* = ED, ON/OFF, 0-10V 1% (700 milliamps), 900 lumens
- 14W = MLV <1% Dimming (700 milliamps), 900 lumens
- 15W* = ED, ON/OFF, 0-10V 1%
- 17W = MLV <1% Dimming, DMX

*Only with no accessories

(c) LED Type Options

- X4LED = Cree XHP50.2 LED

(d) Beam Options

- SP = Spot 17° NFL = Narrow Flood 26°
- FL = Flood 40° LM = Luminosity Flood 50° Vertical Illumination with 5/8" glow extension

(e) Fixture Color Options

- BLK* = Black
- WHT* = White
- PWT* = Pewter
- Select Custom Color (Review Website for Over 3,300 Color Options)

*Zinc based powder coat paint for weatherization

(f) Fixture Length Options

- L4 = Standard 4" Length L12 = 12" Fixture Length
- L18 = 18" Fixture Length L22 = 22" Fixture Length
- C24 - C60 = Custom Size*

*Select any length between 24" and 60" in whole inch increments







(g) Stem Options

- S6 = Stem Size 6" S18 = Stem Size 18"
- S12 = Stem Size 12" CS = Custom Stem (up to 96" for flat canopy)

(h) Installation Options

- 2CP = 2" Canopy Plate BCPS = Blind Canopy Plate Trimless Stem
- 2.75CP = 2.75" Canopy Plate TLP = Trimless Plaster
- 4.5CP = 4.5" Canopy Plate TLW = Trimless Wood

(i) Optical and Accessory Options

- LS = Lens Softener - +20% increase in beam width. Shields optical face visually. Softens edges of beam. 
- LSL = Linear Spread Lens - Horizontal or vertical beam elongation. 
- WFL = Wide Flood Lens - Wall washing increases the beam by 50% width with elimination of center beam. 
- LV = Louver - Small black hexcel louver eliminates all surface brightness. Creates stronger vertical cut off with -20% beam width. 
- CHL = Cross Hair Louver 
- H = Halogen - 100K warmer. 2700k to 2500K 
- DH = Dimmed Halogen - 400K warmer. 2700k to 2300K 

(j) Options

- RMT14 = 14Watt 12V AC MLV Step Down Transformer
- RMT60 = 60Watt 12V AC MLV Step Down Transformer
- RMT150 = 150Watt 12V AC MLV Step Down Transformer
- RMT300 = 300Watt 12V AC MLV Step Down Transformer
- 120V = 120VAC 60Hz (Standard)
- 230V = 230VAC 50Hz
- 277V = 277VAC 60Hz
- WL = IP66 Wet Listed (Pending)
- EMG = Remote 90min Emergency Back-Up
- 80+ = CRI over 80
- 90+ = CRI over 90

(k) Color Temperature Options

- | | | |
|--|--|-------------------------------------|
| White LED | | Colored/Themed LED |
| 22K* = 2200 Kelvin (candlelight color) | | UV365** = 365 NM UV black light |
| 27K = 2700 Kelvin (incandescent color) | | UV390** = 390 NM UV black light |
| 30K = 3000 Kelvin (halogen color) | | Blue* = 465 - 485 NM wavelength |
| 35K = 3500 Kelvin (warm incandescent) | | Green* = 520 - 535 NM wavelength |
| 40K = 4000 Kelvin (cool incandescent) | | Amber* = 585 - 595NM wavelength |
| 50K = 5000 Kelvin (day white) | | Red* = 620 - 630 NM wavelength |
| 65K = 6500 Kelvin (12 noon sunlight) | | RGBW3K*** = Red, Green, Blue, White |
| | | RGBW4K*** = Red, Green, Blue, White |

*1050 mA or less

**700 mA or less

**Must utilize DMX fixture option

SMR1-601-PAR8-FIX

Fixed Mono Point

Project Name:		Type:	
Catalog Number:		Date:	

Trimless - 2-Part Design, 3D printed ASA plastic threaded insert (must utilize remote ELV or 0-10V power supply)

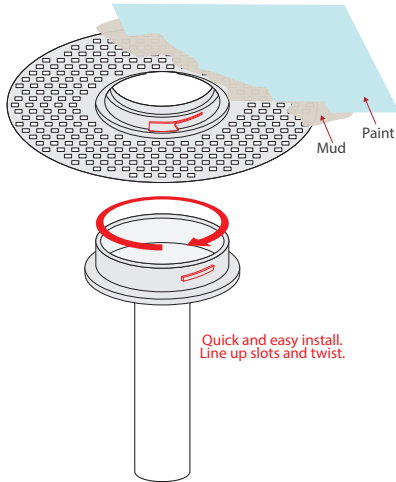

Blind Canopy Trimless Stem, 3D printed ASA plastic mud screen (must utilize remote ELV or 0-10V power supply)

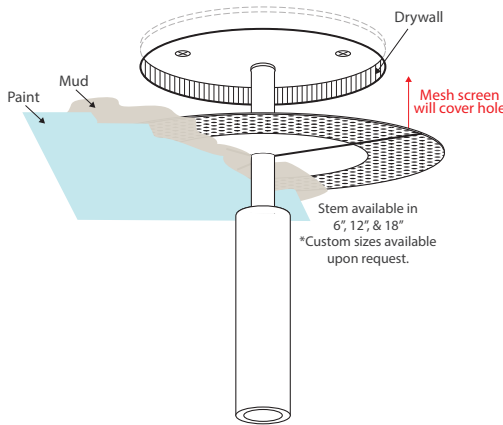

Housing

- 100% aluminum construction

Electrical

- Optional - 12V AC remote class 2
- Optional - 24V DC remote class 2
- 100V, 120V, 230V, 277V or 347V

LED

- CREE XHP50
- 1500 milliamps maximum
- Operates between 350 to 700 milliamps
- 100,000+ L70 life

LED Driver

- D – 2 wire forward phase .01% LED driver fade to off glow to on
- ED – 2 wire reverse phase 1% LED driver
- 0-10V – 3 wire 1% LED driver
- Absolute Light – Remote mount class 2 48V din rail .001% LED system
- 16-bit RMD DMX – 65,536 dimming steps fade to off glow to on

Optics

- TIR discrete injection molded polycarbonate precision LED optic
- 45-degree vertical cut off

Installation

- EMT Connector – Push Lock EMT Connector Installation

Certification

- UL Wet Listed – 66 & 1598A (Pending)

Warranty

- 5 Year = 100,000 hr. L70 life

New Construction and Retrofit

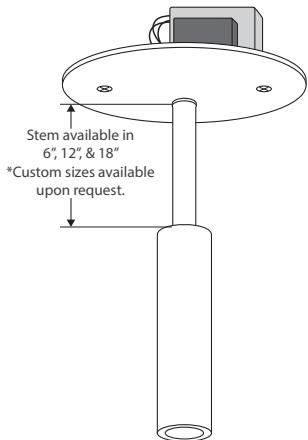

Luminosity Accessory

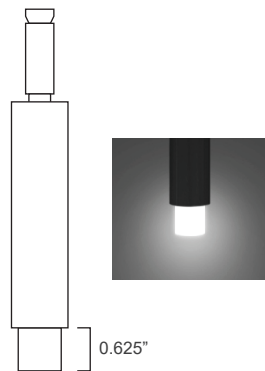

Optional Fixture Lengths (8", 12", & 18")

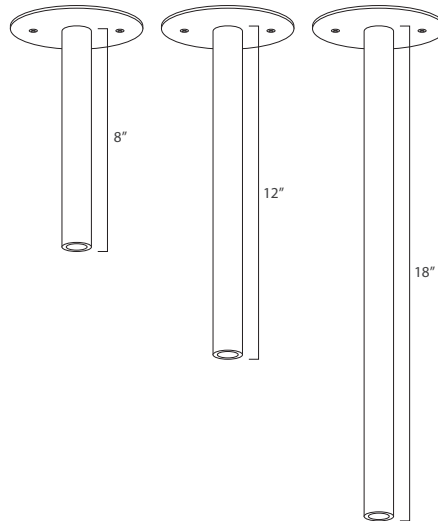

Remote Transformer (2" plate with fixture mounting holes)

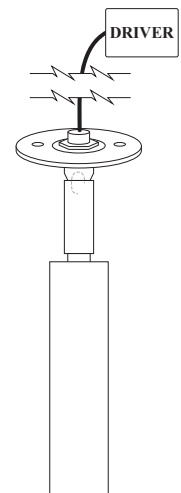

SMR1-601-PAR8-FIX

Fixed Mono Point

Project Name:		Type:	
Catalog Number:		Date:	

Wattage & Lumen Output

350 Milliamps - 450 Lumens

5W	ON/OFF
	0-10V 1% Dimming
7W	MLV <1% Dimming

700 Milliamps - RGBW3K Absolute Light

10W	Red - Up to 150 Lumens
	Green - Up to 150 Lumens
	Blue - Up to 150 Lumens
	White - Up to 300 Lumens

525 Milliamps - 650 Lumens

11W	ON/OFF
	0-10V 1% Dimming

700 Milliamps - 900 Lumens

14W	MLV <1% Dimming
15W	ON/OFF
	0-10V 1% Dimming

3 Step CREE XPL2 LED

Kelvin-CRI	Multiplier
27K-80+ CRI	1
27K-90+ CRI	0.80
30K-80+ CRI	1
30K-90+ CRI	0.85
35K-80+ CRI	105
35K-90+ CRI	0.9
40K-80+ CRI	109
50K-80+ CRI	109
65K-80+ CRI	105

80+ = 84 CRI
90+ = 94 CRI

Narrow Flood 26°

2'	559 fc	0.9'
4'	140 fc	1.9'
6'	62 fc	2.8'
8'	35 fc	3.7'
10'	22 fc	4.7'
12'	16 fc	5.6'

11W PAR8 - 670 lm

Flood 40°

2'	402 fc	1.5'
4'	101 fc	2.9'
6'	45 fc	4.4'
8'	25 fc	5.9'
10'	16 fc	7.4'
12'	11 fc	8.8'

11W PAR8 - 670 lm

Zonal Flux and Percentages

Zone	%Luminaire
0-20	63
0-30	83.3
0-40	89.8
0-60	95.8
0-80	99.2
0-90	100
10-90	77.9
20-40	26.7
20-50	30.6
40-70	8
60-80	3.4
70-80	1.4
80-90	0.8

Zonal Flux and Percentages

Zone	%Luminaire
0-20	47.3
0-30	74.3
0-40	88.5
0-60	97.5
0-80	99.5
0-90	100
10-90	87.1
20-40	41.2
20-50	48.7
40-70	10.1
60-80	2
70-80	0.9
80-90	0.5

Axial Candela Display

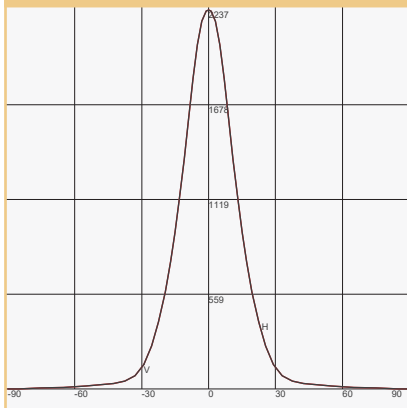

Maximum Candela = 2237 Located At Horizontal Angle = 0, Vertical Angle = 0
H - Horizontal Axial Candela
V - Vertical Axial Candela

Axial Candela Display

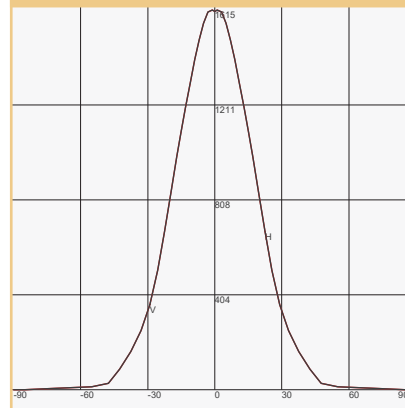

Maximum Candela = 1615 Located At Horizontal Angle = -1, Vertical Angle = 0
H - Horizontal Axial Candela
V - Vertical Axial Candela

Project Name:		Type:	
Catalog Number:		Date:	

Clarté Lighting 3000K 80+ CRI Color Metrics

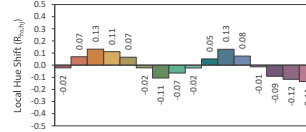
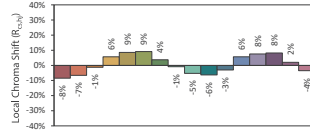
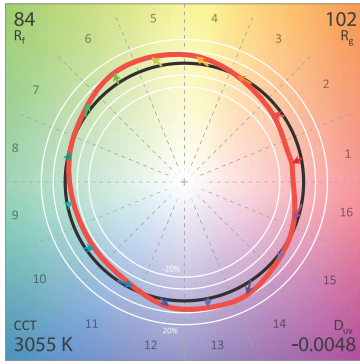

CIE 13.3-1995 (CRI)
 R_a 86
 R_9 29

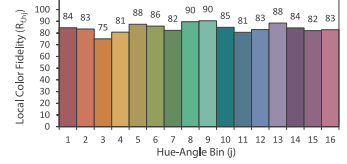
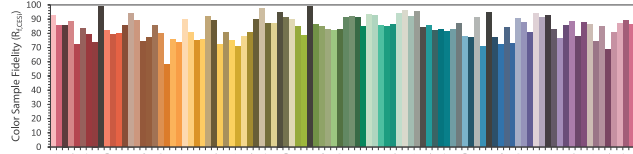

Clarté Lighting 3000K 90+ CRI Color Metrics

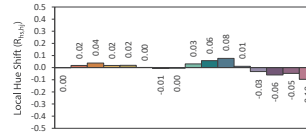
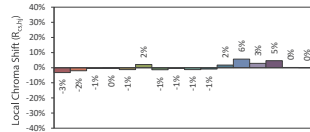
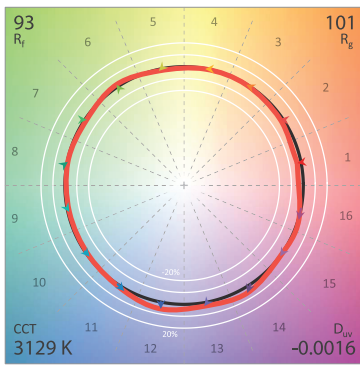

CIE 13.3-1995 (CRI)
 R_a 95
 R_9 74

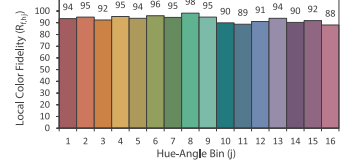
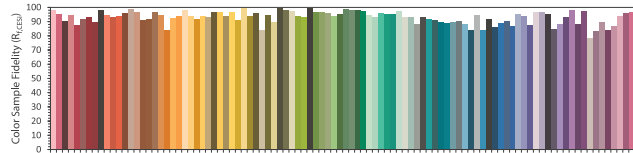

Clarté Lighting 3000K 90+ CRI Halogen Lens (H) Color Metrics

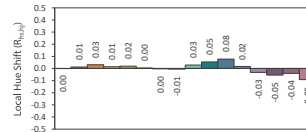
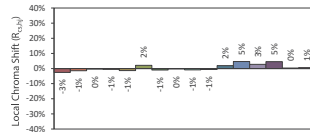
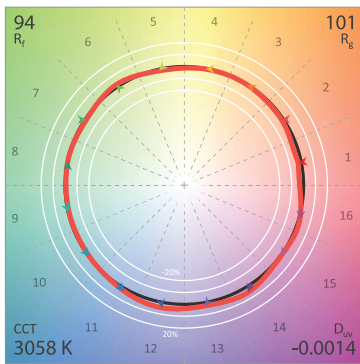

CIE 13.3-1995 (CRI)
 R_a 96
 R_9 79

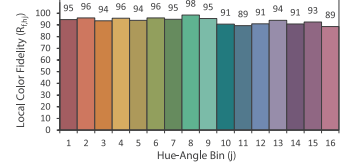
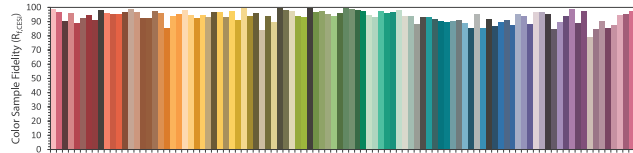

Clarté Lighting 3000K 90+ CRI Dimmed Halogen Lens (DH) Color Metrics

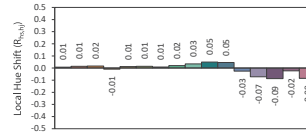
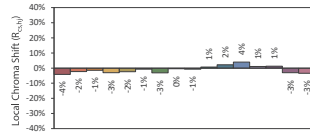
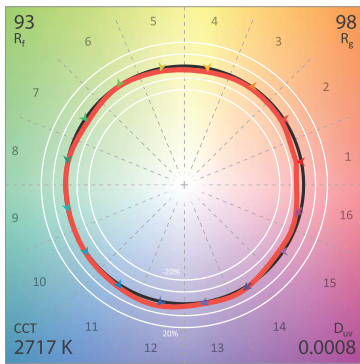

CIE 13.3-1995 (CRI)
 R_a 95
 R_9 64

