

# SDT-838-PAR38

Surface Directional Track

Project Name:		Type:	
Catalog Number:		Date:	

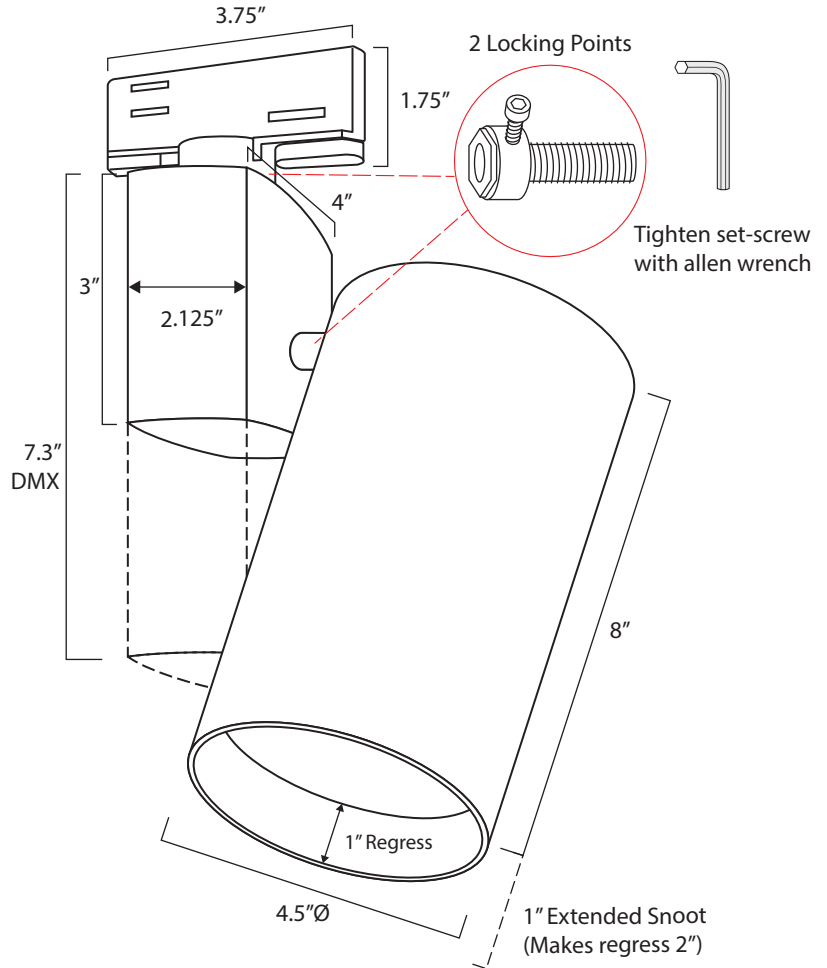
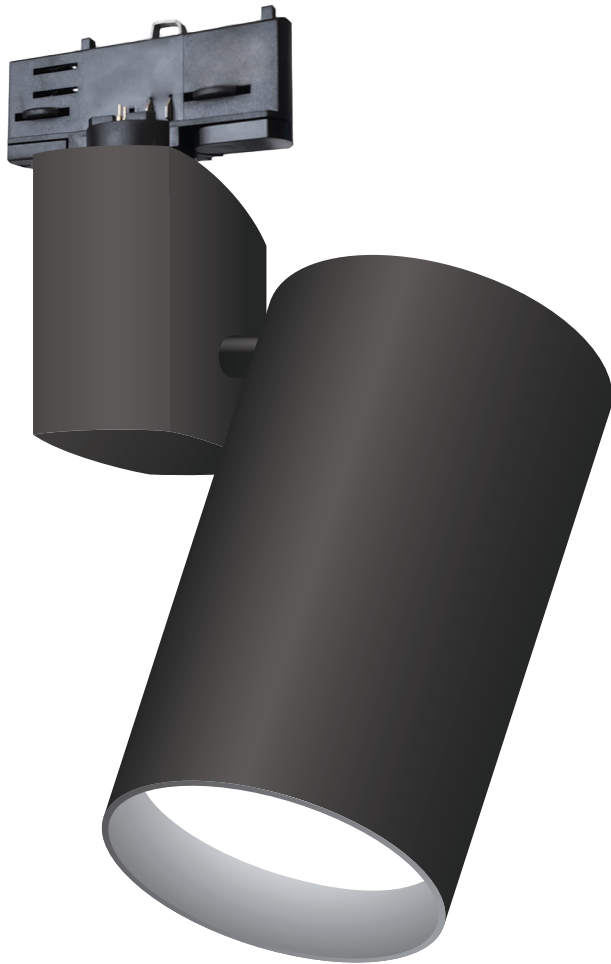

### Key Features

- 4.5" OD
- Up to 4 accessories
- Remote transformer option
- Track adapter options
  - 1C - H type 1 circuit
  - 12C - 120V
  - 12C - 277V
- Over 10,000+ fixture custom color finish options
- 100,000+ hr L70 life
- **See Page 3 for C-Clamp Option**

### LED Source Details

- CREE XPL2 LED maximum rating 3,000 mA
- Fixture operating milliamps = 1,500 mA
  - Fixture Wattage Range = 64W to 68W
  - Fixture Delivered Lumens = 4,500 lumens

Patent Pending

Last revised: 10/10/2023



# Clarté Lighting

## SDT-838-PAR38

Surface Directional Track

Ordering

Project Name:		Type:	
Catalog Number:		Date:	

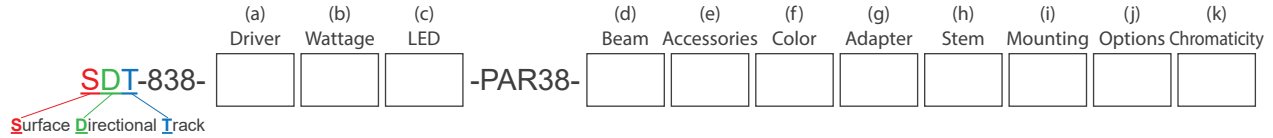

### (a) Driver Options

- E = ON/OFF (Electronic)
- D = MLV 1% Dimming (2 wire)
- DC12V = .01% PWM DC dimming (2 wire)
- DC24V = .01% PWM DC dimming (2 wire)
- 0-10V1 = 0-10V 1% Dimming (3 wire)
- RDM DMX = 8 Bit or 16 Bit, 4 Channel (2 wire with CAT5)

### (b) Wattage Options

- 64W = 1500 milliamps/4500 lumens, ON/OFF, 0-10V
- 68W = 1200 milliamps/3600 lumens, MLV
- 72W = 600 milliamps/3000 lumens, RDM DMX RGBW







### (c) LED Type Options

- CREE XPL2 high intensity = narrow spot (NSP)
- CREE XPL2 high density = spot (SP), narrow flood (NFL), and flood (FL)

### (d) Beam Options

- NSP = Narrow Spot
- SP = Spot
- NFL = Narrow Flood
- FL = Flood

### (e) Optical and Accessory Options

- LS = Lens Softener - +20% increase in beam width. Shields optical face visually. Softens edges of beam. 
- LSL = Linear Spread Lens - Horizontal or vertical beam elongation. 
- WFL = Wide Flood Lens - Wall washing increases the beam by 50% width with elimination of center beam. 
- LV = Louver - Hexcel louver eliminates all surface brightness. Creates stronger vertical cut off with -20% beam width. 
- CHL = Cross Hiar Louver 
- H = Halogen - 150K warmer. 2700k to 2550K 
- DH = Dimmed Halogen - 300K warmer. 2700k to 2400K 

### (f) Fixture Color Options

- BLK = Black
- WHT = White
- PWT = Pewter
- PWTB = Pewter Fixture with Piano Black Interior Snoot
- Select Custom Color (Review Website for Over 3,300 Color Options)

### (g) Track Adapter Options

- 120 = 2-Circuit, 120V
- 277 = 2-Circuit, 277V

### (h) Stem Options

- S6\* = Stem Size 6"
- S12\* = Stem Size 12"
- CS = Custom Stem (up to 96")
- S18 = Stem Size 18"
- S24 = Stem Size 24"

\*Track only 6" or 12"

### (i) Mounting Options

- CLP = C-Clamp
- FCP = Flat Canopy Plate

### (j) Options

- 120V = 120VAC 60Hz (Standard)
- 230V = 230VAC 50Hz (Used in conjunction with 230V track)
- 277V = 277VAC 60Hz (Used in conjunction with 277V track)
- BD = Barn Doors
- ES = Extended Snoot (Optic Snoot Regress Increased to 2")
- FCP = Flat Canopy Plate
- CP = Canopy Plate
- C\* = C-Clamp
- PL\* = Coil Grounded Plug
- LD = Local Dimming Fixture
- DMX\* = .39% to 100% milliamp constant voltage LED driver, dip switch addressable, 3 channel for 27K & 30K, 4 channel for RGBW, CAT5 in & out\*
- 80+ = CRI over 80
- 90+ = CRI over 90

\*DMX is required in RGBA or in any 2 circuits or more.  
Custom colors available - Consult factory for more details

### (k) Color Temperature Options

#### White LED

- 22K\* = 2200 Kelvin (candlelight color)
- 27K = 2700 Kelvin (incandescent color)
- 30K = 3000 Kelvin (halogen color)
- 35K = 3500 Kelvin (warm incandescent)
- 40K = 4000 Kelvin (cool incandescent)
- 50K = 5000 Kelvin (day white)
- 60K = 6500 Kelvin (12 noon sunlight)

#### Colored/Themed LED

- UV275\*\* = 275 NM UV virus sterilizer
- UV365\*\*\* = 365 NM UV black light
- UV390\*\*\*\* = 390 NM UV black light
- Blue\*\*\* = 465 - 485 NM wavelength
- Green\*\*\* = 520 - 535 NM wavelength
- Amber\*\*\* = 585 - 595NM wavelength
- Red\*\*\* = 620 - 630 NM wavelength
- RGBW3K\*\*\*\* = Red, Green, Blue, White
- RGBW4K\*\*\*\* = Red, Green, Blue, White

\*1050 mA or less

\*\*500 mA  
\*\*\*700 mA  
\*\*\*\*Must utilize DMX @ 700 mA

# SDT-838-PAR38

Surface Directional Track

Project Name:		Type:	
Catalog Number:		Date:	

### C-Clamp with MLV

Chord Max Length = Approx 16'  
Chord Compressed Length = Approx 3'

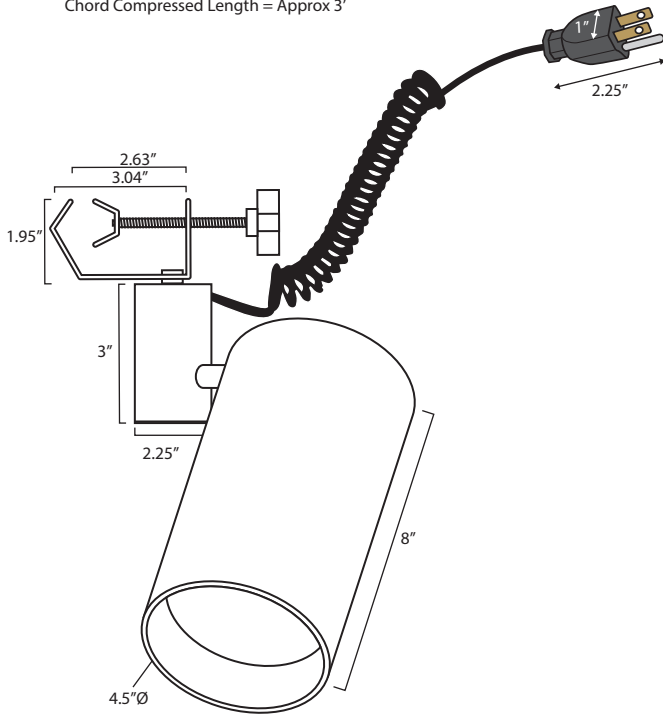

### Flat Canopy Plate

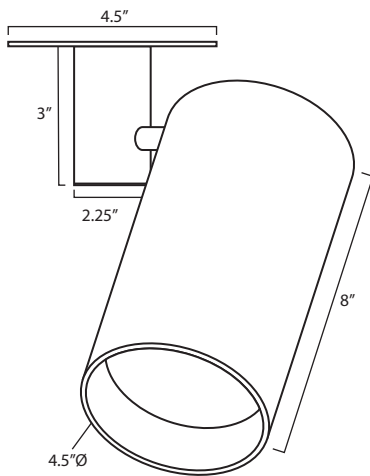

### Housing

- 100% aluminum construction

### Electrical

- Optional - 12V AC remote class 2
- 120V, 230V or 277V

### LED

- 3,000 mA rated CREE XPL2 LED – NSP
- Operating at 1600 milliamps = 53% of maximum rated current

### LED Driver

- D – 2 wire forward phase .01% LED driver fade to off glow to on
- ED – 2 wire reverse phase 1% LED driver
- DC – 12V or 24V
- 0-10V – 3 wire 1% LED driver
- 16-bit RMD DMX – 65,536 dimming steps fade to off glow to on

### Optics

- TIR discrete injection molded polycarbonate precision LED optic
- 45-degree vertical cut off

### Installation

#### Track Adapter

- 1C - H type single circuit
- 2C 120 - 2 circuit 120V
- 2C 277 – 2 circuit 277V

### Certification

- UL Damp Listed – IP 52

### Warranty

- 5 Year – ED, 0-10V, DMX and colored LED fixtures
- 7 Year – D and White LED fixtures

### DMX Track Fixture

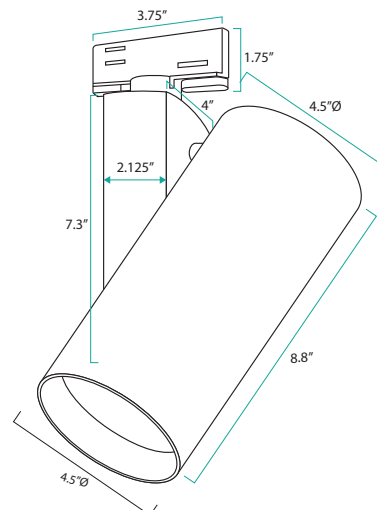

# SDT-838-PAR38

Surface Directional Track

Project Name:		Type:	
Catalog Number:		Date:	

**Wattage & Lumen Output**

1400 Milliamps - 5000 Lumens

68W	ON/OFF
	0-10V 1% Dimming
70W	DMX Dimming

**3 Step CREE XPL2 LED**

Kelvin-CRI	Multiplier
27K-80+ CRI	1
27K-90+ CRI	0.80
30K-80+ CRI	1
30K-90+ CRI	0.85
35K-80+ CRI	105
35K-90+ CRI	0.9
40K-80+ CRI	109
50K-80+ CRI	109
65K-80+ CRI	105

80+ = 84 CRI  
90+ = 94 CRI

**RGBW V2 Light Output Luminous Flux**  
Clarté Lighting offers 100% of fixtures in optional RGBW3K or RGBW4K

	600 mA RGBW3K	700 mA White 3K
Red	1728	
Green	3348	
Blue	497	
White	2808	
<b>Total</b>	<b>8381</b>	<b>3377</b>

\*RGBW Fixtures are designed to not operate with all 4 colors at 100% of light for more than 24hrs continuously and suggest operating 55% or less of all 4 colors ON to ensure optimum thermal life of the RGBW LED.

**Narrow Flood 21°**

Height	Beam Diameter	Beam Spread
2'	5,157 fc	0.7'
4'	1,289 fc	1.5'
6'	573 fc	2.2'
8'	322 fc	3.0'
10'	206 fc	3.7'
12'	143 fc	4.4'

67W PAR38 - 4,266 lm



**Zonal Flux and Percentages**

Zone	Flux (lm)	%Luminaire
0-30	3369	79.0
0-40	3739	87.7
0-60	4197	98.4
0-90	4266	100.0
40-90	527	12.3
60-90	69	1.6
90-180	0	0.0
0-180	4266	100.0

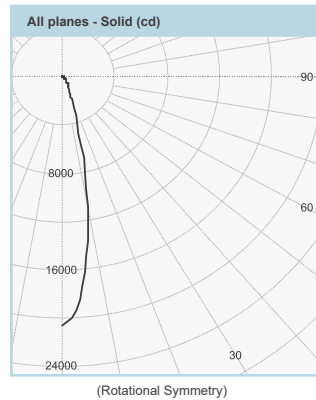

**Intensity Summary (cd)**

Gamma	All Planes	Flux (lm)
0	20628	
5	17468	1451
10	10916	
15	4848	1396
20	1966	
25	1066	522
30	764	
35	582	370
40	476	
45	381	295
50	291	
55	177	163
60	103	
65	73	65
70	14	
75	3	4
80	1	
85	0	1
90	0	

Project Name:		Type:	
Catalog Number:		Date:	

Clarté Lighting 3000K 80+ CRI Color Metrics

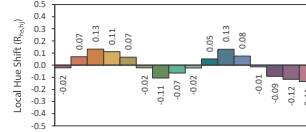
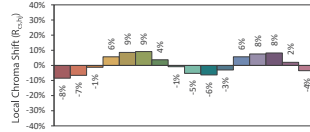
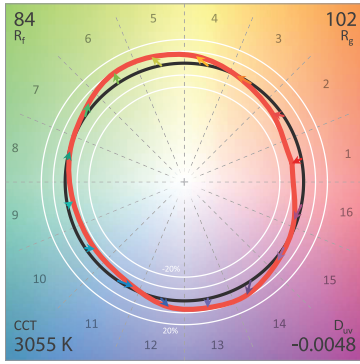

CIE 13.3-1995 (CRI)  
 $R_a$  86  
 $R_g$  29

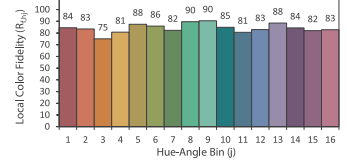
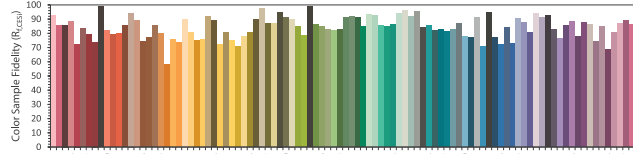

Clarté Lighting 3000K 90+ CRI Color Metrics

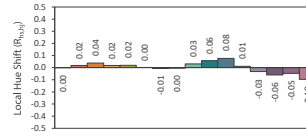
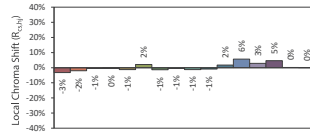
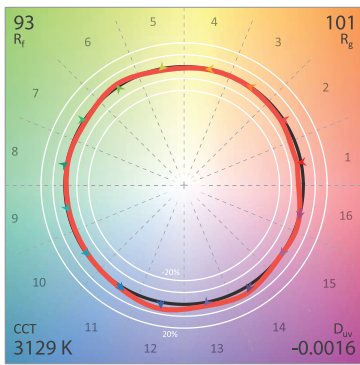

CIE 13.3-1995 (CRI)  
 $R_a$  95  
 $R_g$  74

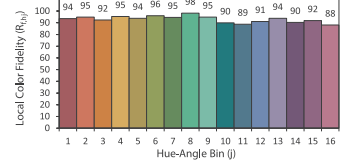
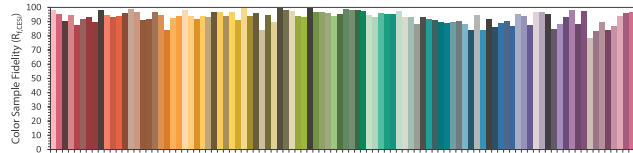

Clarté Lighting 3000K 90+ CRI Halogen Lens (H) Color Metrics

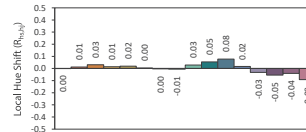
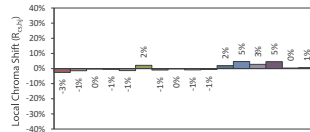
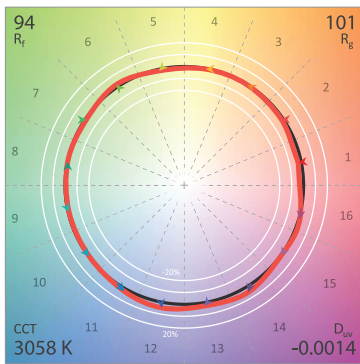

CIE 13.3-1995 (CRI)  
 $R_a$  96  
 $R_g$  79

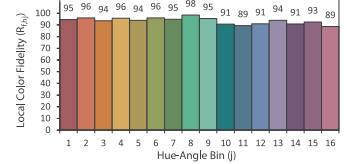
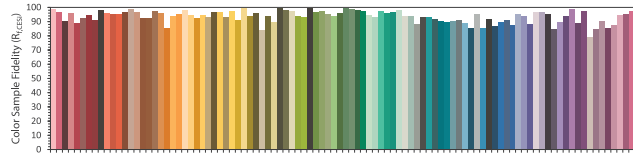

Clarté Lighting 3000K 90+ CRI Dimmed Halogen Lens (DH) Color Metrics

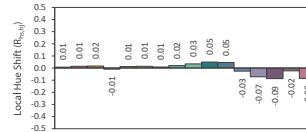
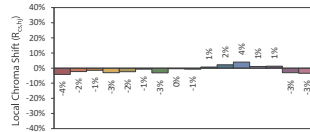
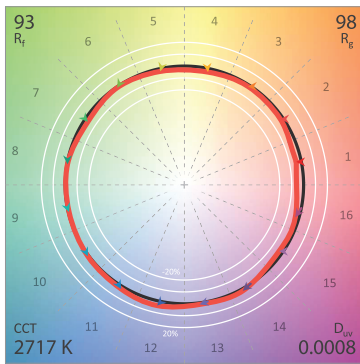

CIE 13.3-1995 (CRI)  
 $R_a$  95  
 $R_g$  64

