

Project Name:		Type:	
Catalog Number:		Date:	

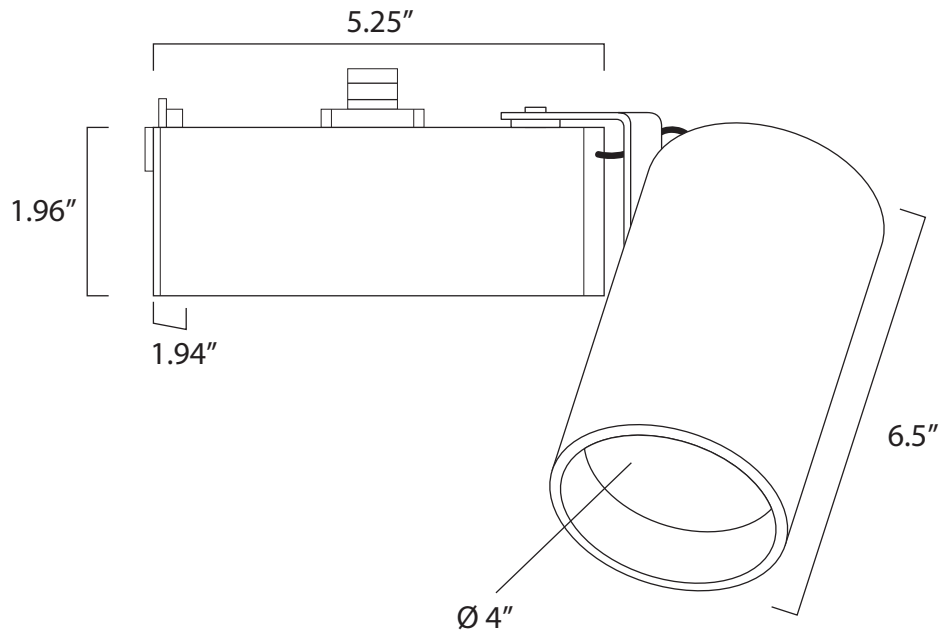

Key Features

- 4" OD
- Up to 4 accessories
- Remote transformer optoin
- Over 10,000+ fixture custom color finish options
- 100,000+ hr L70 life

LED Source Details

- CREE XML2 LED maximum rating 3,000 mA
- Fixture operating milliamps = 700 mA – 1600 mA
 - Operating 23% - 53% of rated value
 - Fixture delivered lumens = up to 3,911 lumens

Patent Pending

Last revised: 10/10/2023

Project Name:		Type:	
Catalog Number:		Date:	

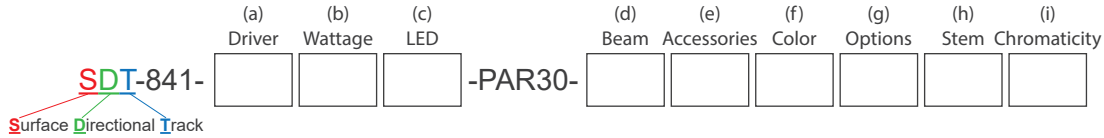

(a) Driver Options

- E = ON/OFF (Electronic)
- D = MLV 1% Dimming (2 wire)
- DC12V = .01% PWM DC dimming (2 wire)
- DC24V = .01% PWM DC dimming (2 wire)
- 0-10V1 = 0-10V 1% Dimming (3 wire)
- RDM DMX = 8 Bit or 16 Bit, 4 Channel (2 wire with CAT5)

(b) Wattage Options

- 27W (450mA, 1300 Lumens) = ON/OFF
- 35W (700mA, 2000 Lumens) = MLV <1% Dimming
- 44W (1000mA, 2800 Lumens) = ON/OFF
- 48W (3300mA, 3300 Lumens) = MLV <1% Dimming, ON/OFF, 0-10V 1%, Lutron, DMX

(c) LED Type Options

- XLED = Cree XPL2 LED @ All Wattages

(d) Beam Options

- NSP = Narrow Spot
- SP = Spot
- NFL = Narrow Flood
- FL = Flood

(e) Optical and Accessory Options

- LS = Lens Softener - +20% increase in beam width. Shields optical face visually. Softens edges of beam.
- LSL = Linear Spread Lens - Horizontal or vertical beam elongation.
- WFL = Wide Flood Lens - Wall washing increases the beam by 50% width with elimination of center beam.
- LV = Louver - Hexcel louver eliminates all surface brightness. Creates stronger vertical cut off with -20% beam width.
- CHL = Cross Hair Louver
- H = Halogen - 150K warmer. 2700k to 2550K
- DH = Dimmed Halogen - 300K warmer. 2700k to 2400K

(f) Fixture Color Options

- BLK = Black
- WHT = White
- PWT = Pewter
- Select Custom Color (Review Website for Over 3,300 Color Options)

(g) Track Adapter Options

- 2C 120V = 2 circuit 120V
- 2C 277 = 2 circuit 277V
- 2C 230 = 2 circuit 230V

(h) Options

- BTS = Black Tapered Snoot
- WTS = White Tapered Snoot
- WBTS = White Exterior / Black Interior
- WWSN = Wall Wash Snoot
- 80+ = CRI over 80
- 90+ = CRI over 90
- 120V = 120VAC 60Hz (Standard)
- 230V = 230VAC 50Hz (Used in conjunction with 230V track)
- 277V = 277VAC 60Hz (Used in conjunction with 277V track)
- FCP = Flat Canopy Plate
- CP = Canopy Plate
- C* = C-Clamp
- PL* = Coil Grounded Plug
- LD = Local Dimming Fixture
- DMX* = .39% to 100% milliamp constant voltage LED driver, dip switch addressable, 3 channel for 27K & 30K, 4 channel for RGBW, CAT5 in & out*

*DMX is required in RGBA or in any 2 circuits or more.
Custom colors available - Consult factory for more details

(i) Stem Options

- S6* = Stem Size 6"
- S12* = Stem Size 12"
- CS = Custom Stem (up to 96")
- S18 = Stem Size 18"
- S24 = Stem Size 24"

*Track only 6" or 12"

(j) Color Temperature Options

White LED

- 22K* = 2200 Kelvin (candlelight color)
- 27K = 2700 Kelvin (incandescent color)
- 30K = 3000 Kelvin (halogen color)
- 35K = 3500 Kelvin (warm incandescent)
- 40K = 4000 Kelvin (cool incandescent)
- 50K = 5000 Kelvin (day white)
- 60K = 6500 Kelvin (12 noon sunlight)

Colored/Themed LED

- UV275** = 275 NM UV virus sterilizer
- UV365*** = 365 NM UV black light
- UV390*** = 390 NM UV black light
- Blue*** = 465 - 485 NM wavelength
- Green*** = 520 - 535 NM wavelength
- Amber*** = 585 - 595NM wavelength
- Red*** = 620 - 630 NM wavelength
- RGBW3K**** = Red, Green, Blue, White
- RGBW4K**** = Red, Green, Blue, White

*1050 mA or less

**500 mA

***700 mA

****Must utilize DMX @ 700 mA

Project Name:		Type:	
Catalog Number:		Date:	

Hinged Barn Doors

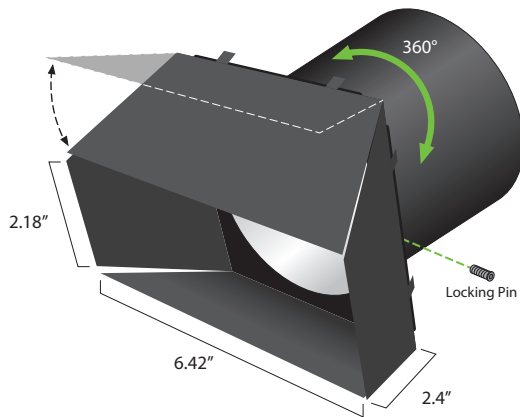

DMX Driver Option

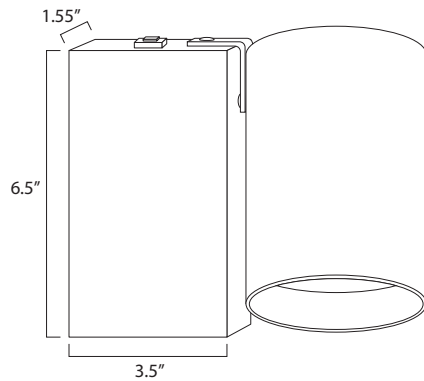
**Housing**

- 100% aluminum construction

Electrical

- Optional - 12V AC remote class 2
- 120V, 230V or 277V

LED

- 3,000mA maximum rated CREE XPL2 LED
- Operates between 450 to 1200mA
- 15% to 40% of rated mA

LED Driver

- D – 2 wire forward phase .01% LED driver fade to off glow to on
- AC – 2 wire 12V AC

Optics

- TIR discrete injection molded polycarbonate precision LED optic
- 45-degree vertical cut off

Installation

Track Adapter

- 1C - H type single circuit
- 2C 120 - 2 circuit 120V
- 2C 277 - 2 circuit 277V

Certification

- UL Damp Listed – IP 52

Warranty

- 7 Year – D and White LED fixtures

Project Name:		Type:	
Catalog Number:		Date:	

Wattage & Lumen Output

700 Milliamps - 1800 Lumens
22W
1000 Milliamps - 2500 Lumens
33W
1200 Milliamps - 3100 Lumens
42W
1400 Milliamps - 3400 Lumens
46W
1600 Milliamps - 3900 Lumens
55W

3 Step CREE XPL2 LED

Kelvin-CRI	Multiplier
27K-80+ CRI	1
27K-90+ CRI	0.80
30K-80+ CRI	1
30K-90+ CRI	0.85
35K-80+ CRI	105
35K-90+ CRI	0.9
40K-80+ CRI	109
50K-80+ CRI	109
65K-80+ CRI	105
80+ = 84 CRI	
90+ = 94 CRI	

RGBW V2 Light Output Luminous Flux

Clarté Lighting offers 100% of fixtures in optional RGBW3K or RGBW4K

	600 mA RGBW3K	700 mA White 3K
Red	1296	
Green	2511	
Blue	372	
White	2106	
Total	6285	2533

*RGBW Fixtures are designed to not operate with all 4 colors at 100% of light for more than 24hrs continuously and suggest operating 55% or less of all 4 colors ON to ensure optimum thermal life of the RGBW LED.

Spot 19°

4'	1,370 fc	1.4'
6'	609 fc	2.1'
8'	342 fc	2.8'
10'	219 fc	3.5'
12'	152 fc	4.2'
20'	55 fc	7.0'
26.7'	31 fc	9.4'
40'	14 fc	14.0'

55W PAR30 - 3,607 lm

Narrow Spot 12°

2'	11,097 fc	0.4'
4'	2,774 fc	0.9'
6'	1,233 fc	1.3'
8'	694 fc	1.7'
10'	444 fc	2.1'
12'	308 fc	2.6'

55W PAR30 - 3,372 lm

Intensity Summary (cd)

Gamma	All Planes	Flux (lm)
0	44389	
5	27240	1963
10	9044	
15	2798	872
20	854	
25	440	214
30	285	
35	211	135
40	172	
45	133	105
50	102	
55	57	56
60	45	
65	29	25
70	3	
75	1	1
80	1	
85	0	0
90	0	

Zonal Flux and Percentages

Zone	Flux (lm)	%Luminaire
0-30	3049	90.4
0-40	3784	94.4
0-60	3345	99.2
0-90	3372	100.0
40-90	188	5.6
60-90	27	0.8
90-180	0	0.0
0-180	3372	100.0

All planes - Solid (cd)

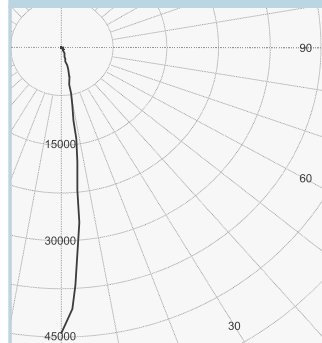

Narrow Flood 22°

4'	1,192 fc	1.5'
6'	530 fc	2.2'
8'	298 fc	2.9'
10'	191 fc	3.6'
12'	132 fc	4.4'
20'	48 fc	7.3'
26.7'	27 fc	9.7'
40'	12 fc	14.5'

55W PAR30 - 3,481 lm

Intensity Summary (cd)

Gamma	All Planes	Flux (lm)
0	19074	
5	16233	1332
10	9848	
15	5190	1461
20	2626	
25	1289	620
30	632	
35	329	220
40	211	
45	146	114
50	98	
55	57	55
60	42	
65	27	26
70	14	
75	9	10
80	6	
85	2	3
90	0	

Zonal Flux and Percentages

Zone	Flux (lm)	%Luminaire
0-30	3413	88.8
0-40	3633	94.6
0-60	3802	99.0
0-90	3840	100.0
40-90	208	5.4
60-90	39	1.0
90-180	0	0.0
0-180	3841	100.0

All planes - Solid (cd)

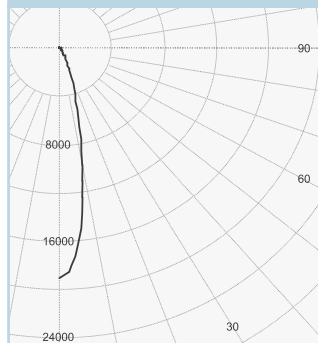

Flood 32°

4'	403 fc	2.3'
6'	179 fc	3.4'
8'	101 fc	4.5'
10'	65 fc	5.7'
12'	45 fc	6.8'
20'	16 fc	11.3'
26.7'	9 fc	15.1'
40'	4 fc	22.7'

55W PAR30 - 3,245 lm

Intensity Summary (cd)

Gamma	All Planes	Flux (lm)
0	6451	
5	5949	529
10	4754	
15	3424	944
20	2326	
25	1552	720
30	1033	
35	639	405
40	368	
45	227	181
50	145	
55	88	83
60	58	
65	39	39
70	21	
75	14	15
80	9	
85	4	4
90	0	

Zonal Flux and Percentages

Zone	Flux (lm)	%Luminaire
0-30	2193	75.1
0-40	2598	89.0
0-60	2862	98.0
0-90	2919	100.0
40-90	321	11.0
60-90	58	2.0
90-180	0	0.0
0-180	2919	100.0

All planes - Solid (cd)

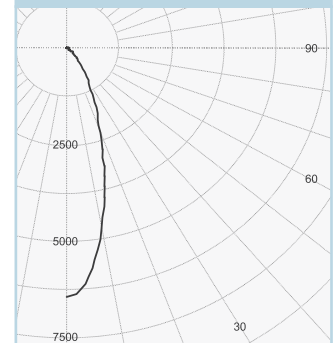

Project Name:		Type:	
Catalog Number:		Date:	

Clarté Lighting 3000K 80+ CRI Color Metrics

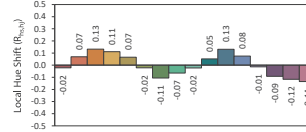
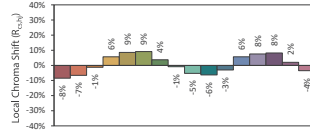
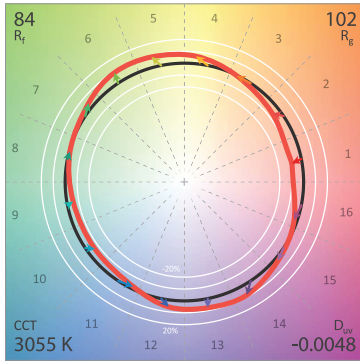

CIE 13.3-1995 (CRI)
 R_a 86
 R₉ 29

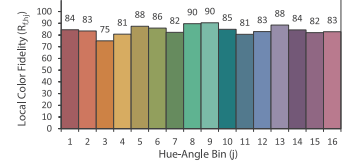
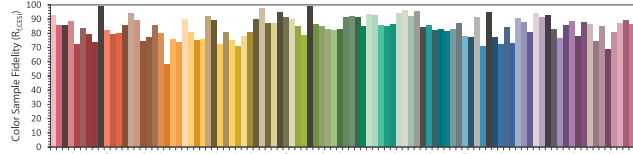

Clarté Lighting 3000K 90+ CRI Color Metrics

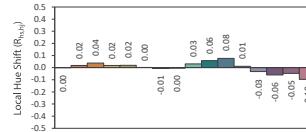
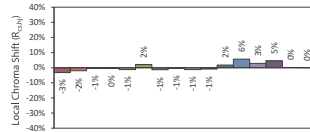
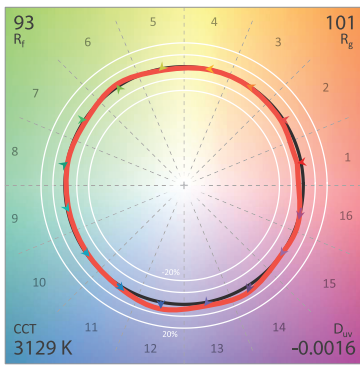

CIE 13.3-1995 (CRI)
 R_a 95
 R₉ 74

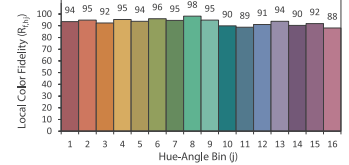
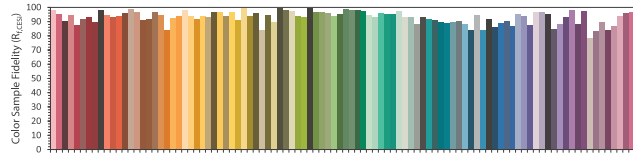

Clarté Lighting 3000K 90+ CRI Halogen Lens (H) Color Metrics

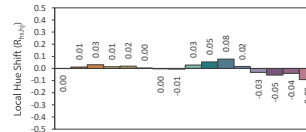
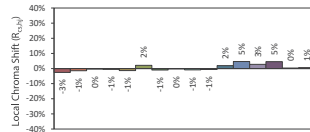
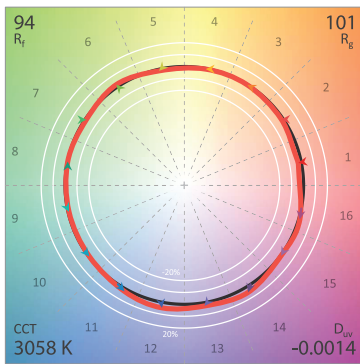

CIE 13.3-1995 (CRI)
 R_a 96
 R₉ 79

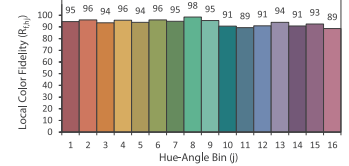
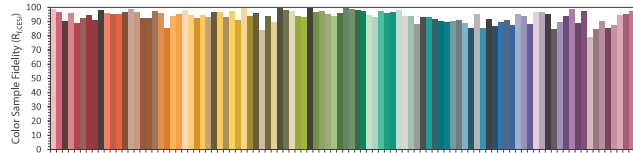

Clarté Lighting 3000K 90+ CRI Dimmed Halogen Lens (DH) Color Metrics

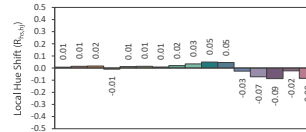
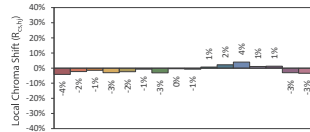
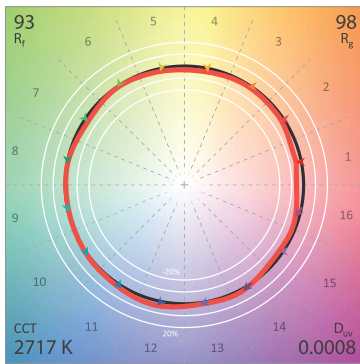

CIE 13.3-1995 (CRI)
 R_a 95
 R₉ 64

