

Project Name:		Type:	
Catalog Number:		Date:	

## Standard Track Adapter - 12V AC

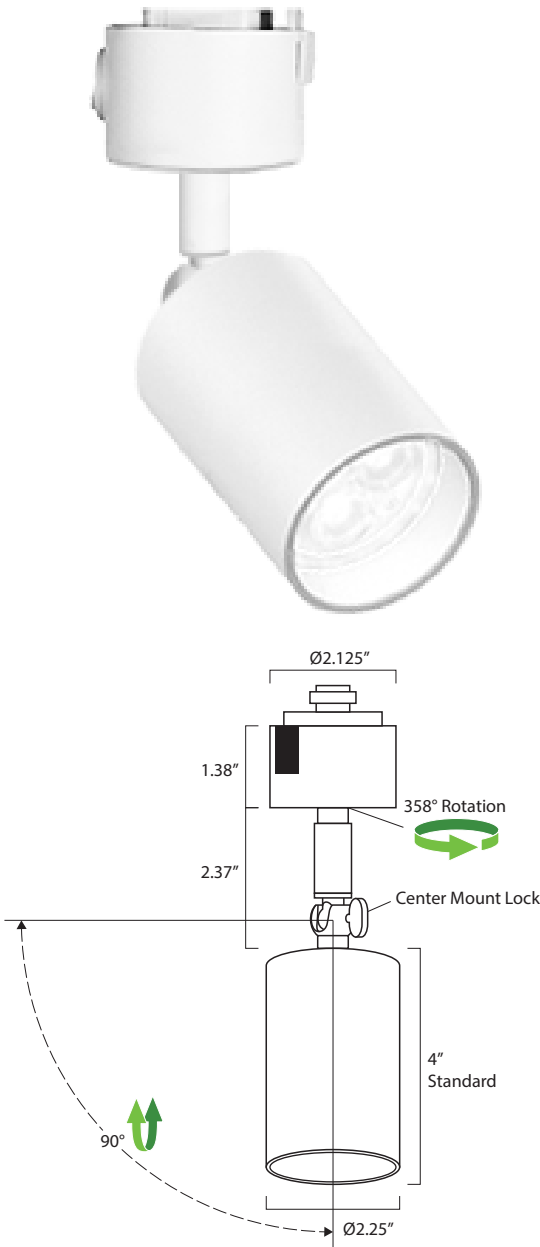

## Micro Data Track Adapter - 48V

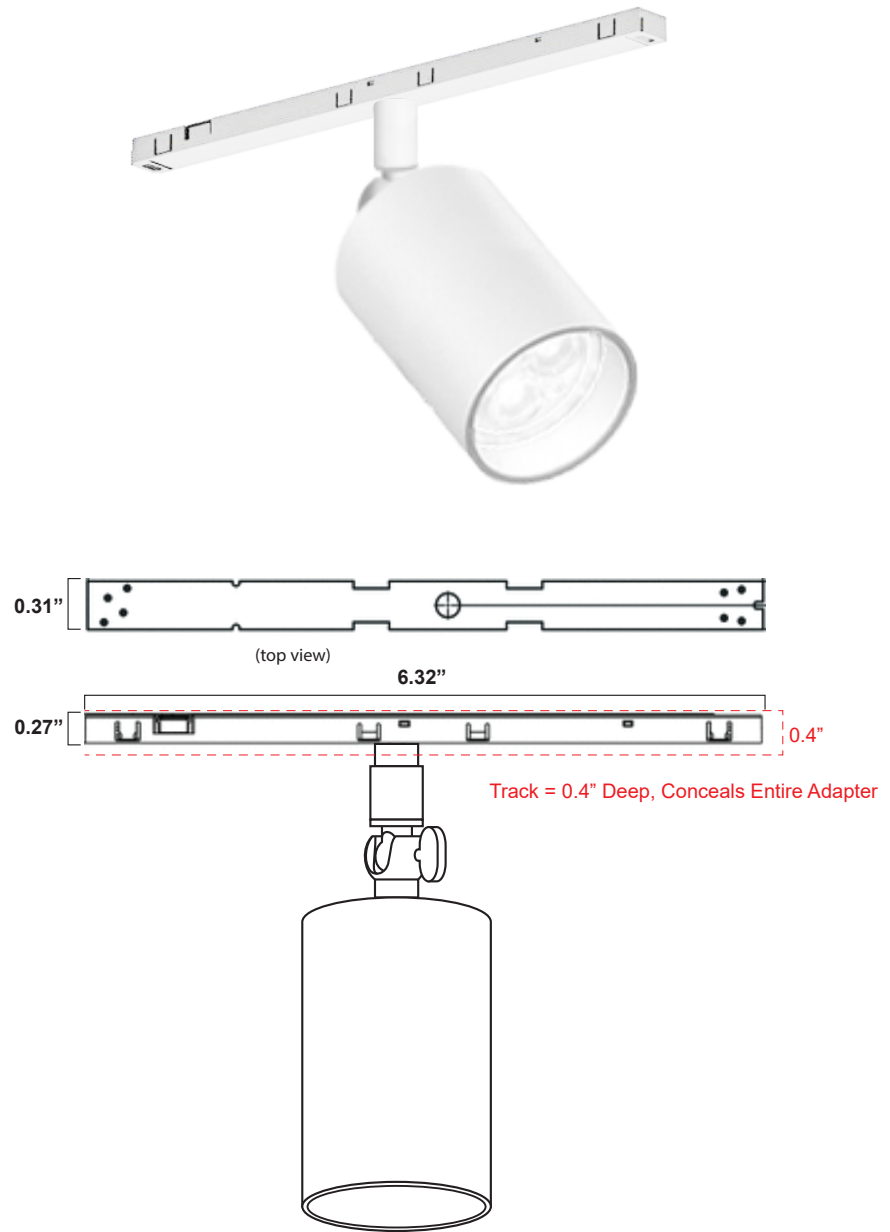

### Key Features

- 2.25" OD
- Up to 4 accessories
- Toolless locking LED optic
- 358° Rotation on CML stem
- 90° Rotation on CML knuckle
- Remote transformer optoin
- Over 10,000+ fixture custom color finish options
- 100,000+ hr L70 life
- **See Page 3 for additional mounting options**

### LED Source Details

- CREE XPL LED maximum rating = 3,000mA
- Fixture operating milliamp range = 450mA to 1150mA.
  - Operating 15% to 38% of rated value
  - Fixture wattage range = 8W to 20W
  - Fixture delivered lumens = 700 to 1,300 lumens

Last revised: 01/24/2024

Project Name:		Type:	
Catalog Number:		Date:	

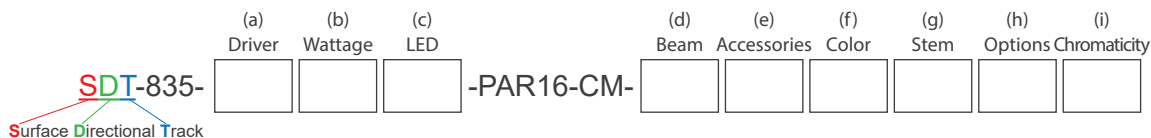

**(a) Driver Options**

D	= MLV 1% Dimming (2 wire)
E	= ON/OFF (Electronic)
DALI2	= .01% Digital Addressable Lighting Interface V2

**(b) Wattage Options**

9W (520 Lumens)	= MLV <1% Dimming
14W (800 Lumens)	= MLV <1% Dimming
17W (1100 Lumens)	= MLV <1% Dimming

**(c) LED Type Options**

XLED	= Cree XPL2 LED @ All Wattages
------	--------------------------------

**(d) Beam Options**

NSP	= Narrow Spot	NFL	= Narrow Flood
SP	= Spot	FL	= Flood

**(e) Optical and Accessory Options**

LS	= Lens Softener - +20% increase in beam width. Shields optical face visually. Softens edges of beam.	
LSL	= Linear Spread Lens - Horizontal or vertical beam elongation.	
WFL	= Wide Flood Lens - Wall washing increases the beam by 50% width with elimination of center beam.	
LV	= Louver - Hexcel louver eliminates all surface brightness. Creates stronger vertical cut off with -20% beam width.	
CHL	= Cross Hair Louver	
H	= Halogen - 150K warmer. 2700k to 2550K	
DH	= Dimmed Halogen - 300K warmer. 2700k to 2400K	

**(f) Fixture Color Options**

BLK	= Black
WHT	= White
PWT	= Pewter

Select Custom Color (Review Website for Over 3,300 Color Options)

**(g) Stem Options**

S6*	= Stem Size 6"	S18*	= Stem Size 18"
S12*	= Stem Size 12"	CS	= Custom Stem (up to 96" for flat canopy)

\*Track only 6", 12", or 18"

**(h) Options**

MT	= Micro Track
BTS	= Black Tapered Snoot
WTS	= White Tapered Snoot
WBTS	= White Exterior / Black Interior
WWSN	= Wall Wash Snoot
80+	= CRI over 80
90+	= CRI over 90
RMT60	= 60 watt 12V AC MLV Step Down Transformer
RMT150	= 150 watt 12V AC MLV Step Down Transformer
RMT300	= 300 watt 12V AC MLV Step Down Transformer
12V	= Up to 6 Fixtures - Add 12V AC Magnetic Step Down Transformer to Operate Track
120V	= 120VAC 60Hz (Standard)
230V	= 230VAC 50Hz (Used in conjunction with 230V track)
277V	= 277VAC 60Hz (Used in conjunction with 277V track)
347V	= 347VAC 60Hz
FCP	= 4.5" Flat Canopy Plate
SFCP	= 2.75" Small Flat Canopy Plate
RCP	= 2.125" Remote Transformer Canopy Plate
C*	= C-Clamp
PL*	= Coil Grounded Plug
HLO	= Halo ( <b>Standard</b> )
EXT	= Exterior zinc primer with zinc infused paint
AWN	= Athena Wireless Node (use with DALI2)
AWNP	= Athena Wireless Node Photocell (use with DALI2)

**(i) Color Temperature Options**

White LED	Colored/Themed LED
22K* = 2200 Kelvin (candlelight color)	UV275** = 275 NM UV virus sterilizer
27K = 2700 Kelvin (incandescent color)	UV365*** = 365 NM UV black light
30K = 3000 Kelvin (halogen color)	UV390*** = 390 NM UV black light
35K = 3500 Kelvin (warm incandescent)	Blue*** = 465 - 485 NM wavelength
40K = 4000 Kelvin (cool incandescent)	Green*** = 520 - 535 NM wavelength
50K = 5000 Kelvin (day white)	Amber*** = 585 - 595NM wavelength
65K = 6500 Kelvin (12 noon sunlight)	Red*** = 620 - 630 NM wavelength

\*\*500 mA  
\*\*\*700 mA

\*1050 mA or less

# SDT-835-PAR16-CM

## Vertical Round Center Mount Track

Project Name:		Type:	
Catalog Number:		Date:	

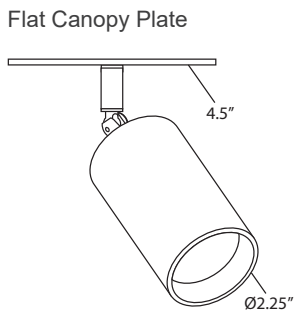
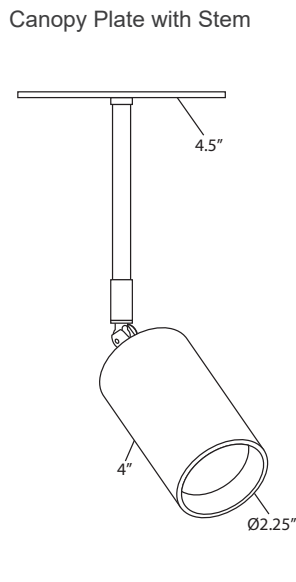
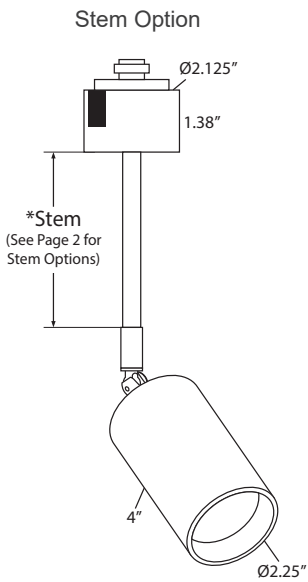

Canopy Plate Available In:  
 4.5" = (FCP) Line Voltage Junction Box  
 2.75" = (SFCP) In-Line Transformer  
 2.125" = (RCP) Remote Transformer

Tapered Snoot (TSN) - Reduce surface brightness and diameter of the beam field with a 1.44" opening, a -36% reduction in the optic face.

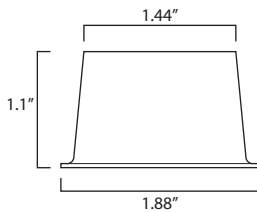

### Housing

- 100% aluminum construction

### Electrical

- Line Voltage Track - 120V or 277V into remote step down 12V AC low voltage magnetic transformer (D)
- Micro Track - 120V or 277V into Remote 12V AC magnetic low voltage (D) OR
- 24V Constant Voltage into ON/OFF or DALI2 into 48V rated track

### Track

- 100% extruded aluminum

### Track Adapter

- Micro Track – Stucchi Micro 48V Track Adapter
- Standard Track – Stucchi 120V or 277V ONE Track System Adapter

### Track Type Options

- Micro Track – Surface, Round and Recessed
- Standard Track – Surface, Round, Recessed and Trimless

### LED

- 3,000mA maximum rated CREE XPL2 LED
- Operates between 450mA to 1200mA
- 15% to 40% of rated mA

### LED Driver

- D - .1% magnetic low voltage forward phase dimming
- E - ON and OFF constant current LED driver
- DALI2 - .1% Digital Dali programmable LED dimmable addressable driver

### Optics

- TIR discrete injection molded polycarbonate precision LED optic with high center beam candle power with 45-degree vertical cut off visually

### Installation

- Open platform

### Certification

- UL Damp Listed – IP 52

### Warranty

- 5 Year – 5 Year - E & DALI2
- 7 Year – D

Project Name:		Type:	
Catalog Number:		Date:	

Track Size Comparison

SURFACE 120V/277V Class 1 Track

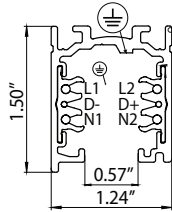

MICRO SURFACE 48V Class 2 Track

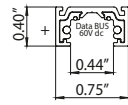

**84% Smaller**

ROUND 120V/277V Class 1 Track

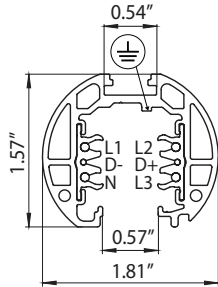

MICRO ROUND 48V Class 2 Track

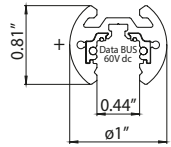

**71% Smaller**

TRIMLESS 120V/277V Class 1 Track

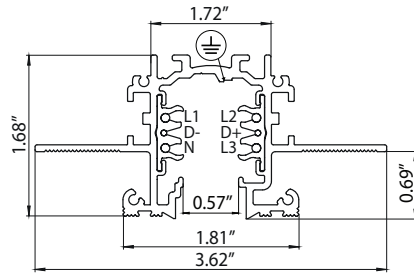

MICRO TRIMLESS 48V Class 2 Track

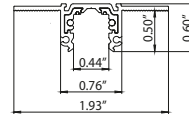

**76% Smaller**

Track Composition Example

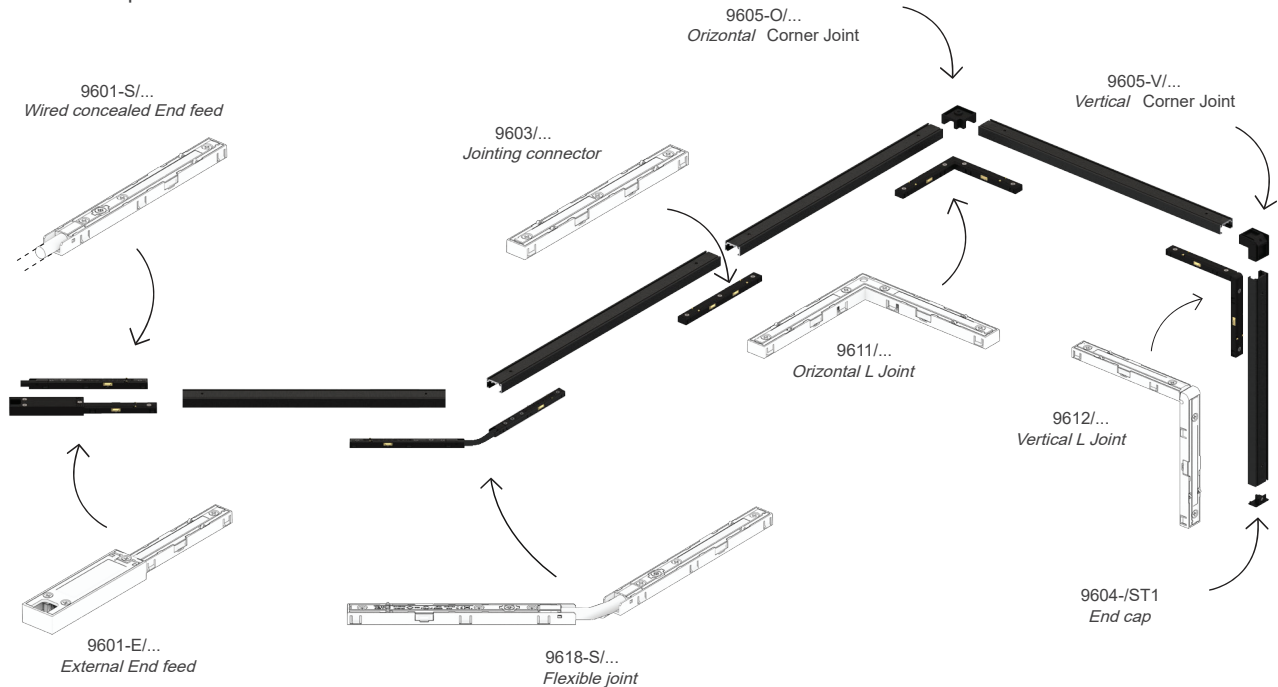

# SDT-835-PAR16-CM

## Vertical Round Center Mount Track

Project Name:		Type:	
Catalog Number:		Date:	

### Narrow Narrow Spot 8.5°

3.3'	1,028 fc	0.5'
6.7'	249 fc	1.0'
10'	112 fc	1.5'
13.3'	63.3 fc	2.0'
16.7'	40.1 fc	2.5'
20'	28 fc	3.0'
26.7'	15.7 fc	4.0'
33.3'	10.1 fc	5.0'
40'	7 fc	6.0'

20W PAR16 - 472 lm  
11,195 CBCP

### Wattage & Lumen Output

450 Milliamps - 520 Lumens		700 Milliamps - 800 Lumens	
8W	ON/OFF	12W	ON/OFF
	0-10V 1% Dimming		0-10V 1% Dimming
9W	MLV <1% Dimming		ELV 10% Dimming
		14W	MLV <1% Dimming
1000 Milliamps - 1100 Lumens		1150 Milliamps - 1300 Lumens	
16W	ON/OFF	20W	ON/OFF
	0-10V 1% Dimming		0-10V 1% Dimming
	ELV 10% Dimming		ELV 10% Dimming
17W	MLV <1% Dimming		
19W	Lutron 1% Dimming		
	DMX .33% Dimming		

### 3 Step CREE XPL2 LED

Kelvin-CRI	Multiplier
27K-80+ CRI	1
27K-90+ CRI	0.80
30K-80+ CRI	1
30K-90+ CRI	0.85
35K-80+ CRI	105
35K-90+ CRI	0.9
40K-80+ CRI	109
50K-80+ CRI	109
65K-80+ CRI	105
80+ = 84 CRI	
90+ = 94 CRI	

### RGBW V2 Light Output Luminous Flux

Clarté LED Lighting offers 100% of fixtures in optional RGBW3K or RGBW4K

	700 mA RGBW3K	700 mA White 3K
Red	160	
Green	310	
Blue	46	
White	260	
<b>Total</b>	<b>776</b>	<b>970</b>

\*RGBW Fixtures are designed to not operate with all 4 colors at 100% of light for more than 24hrs continuously and suggest operating 55% or less of all 4 colors ON to ensure optimum thermal life of the RGBW LED.

### Zonal Flux and Percentages

Zone	Flux (lm)	%Luminaire
0-30	460	97.5
0-40	467	99.0
0-60	472	100.0
0-90	472	100.0
40-70	5	1.0
60-80	0	0.0
90-180	0	0.0
0-180	472	100.0

### Narrow Spot 12°

2'	3,824 fc	0.4'
4'	956 fc	0.9'
6'	425 fc	1.3'
8'	239 fc	1.8'
10'	153 fc	2.2'
12'	106 fc	2.7'
20'	28 fc	5.2'
26'	16 fc	7.0'
33'	10 fc	8.7'
40'	7 fc	10.5'

20W PAR16 - 1,100 lm  
15,296 CBCP

### Spot 19°

2'	1,939 fc	0.7'
4'	485 fc	1.4'
6'	215 fc	2.0'
8'	121 fc	2.7'
10'	78 fc	3.4'
12'	54 fc	4.1'
20'	28 fc	6.1'
26'	16 fc	8.1'
33'	10 fc	10.1'
40'	7 fc	12.1'

20W PAR16 - 1,313 lm  
7,757 CBCP

### Narrow Flood 24°

2'	1,705 fc	0.7'
4'	426 fc	1.4'
6'	189 fc	2.1'
8'	107 fc	2.8'
10'	68 fc	3.5'
12'	47 fc	4.3'
20'	17 fc	7.5'
26'	10 fc	10.0'
33'	6 fc	12.4'
40'	5 fc	14.9'

20W PAR16 - 1,306 lm  
5,478 CBCP

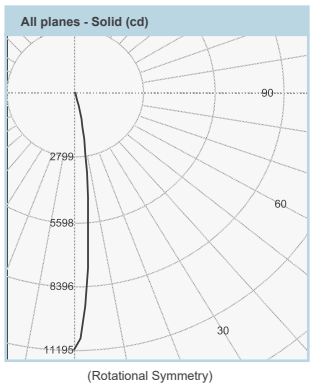

### Intensity Summary (cd)

Gamma	All Planes	Flux (lm)
0	15296	
5	9739	696
10	2978	
15	676	236
20	229	
25	135	64
30	90	
35	67	43
40	53	
45	46	35
50	34	
55	23	21
60	15	
65	2	4
70	1	
75	0	0
80	0	
85	0	0
90	0	

### Intensity Summary (cd)

Gamma	All Planes	Flux (lm)
0	7757	
5	6432	519
10	3640	
15	1648	475
20	731	
25	336	166
30	176	
35	110	71
40	77	
45	67	50
50	47	
55	29	26
60	15	
65	3	5
70	1	
75	0	1
80	0	
85	0	0
90	0	

### Intensity Summary (cd)

Gamma	All Planes	Flux (lm)
0	5478	
5	4774	404
10	3229	
15	1800	500
20	905	
25	452	219
30	244	
35	146	95
40	98	
45	75	57
50	47	
55	25	25
60	15	
65	3	5
70	1	
75	1	1
80	0	
85	0	0
90	0	

### Narrow Narrow Spot 7.9° (with Louver)

3.3'	953 fc	0.5'
6.7'	231 fc	0.9'
10'	104 fc	1.4'
13.3'	58.7 fc	1.8'
16.7'	37.2 fc	2.3'
20'	25.9 fc	2.8'
26.7'	14.6 fc	3.7'
33.3'	9.36 fc	4.6'
40'	6.48 fc	5.5'

20W PAR16 - 382 lm  
10,376 CBCP

### Zonal Flux and Percentages

Zone	Flux (lm)	%Luminaire
0-30	997	90.6
0-40	1040	94.6
0-60	1096	99.6
0-90	1100	100.0
40-90	60	5.4
60-90	4	0.4
90-180	0	0.0
0-180	1100	100.0

### Zonal Flux and Percentages

Zone	Flux (lm)	%Luminaire
0-30	1160	88.3
0-40	1231	93.8
0-60	1308	99.6
0-90	1313	100.0
40-90	82	6.2
60-90	5	0.4
90-180	0	0.0
0-180	1313	100.0

### Zonal Flux and Percentages

Zone	Flux (lm)	%Luminaire
0-30	1123	86.0
0-40	1219	93.3
0-60	1301	99.6
0-90	1306	100.0
40-90	88	6.7
60-90	6	0.4
90-180	0	0.0
0-180	1306	100.0

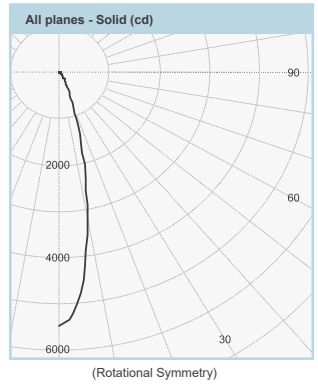
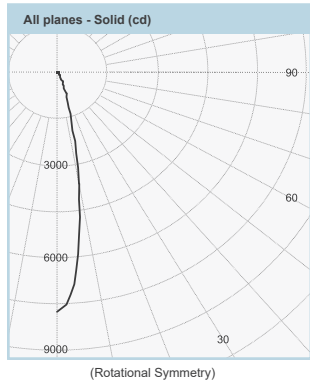
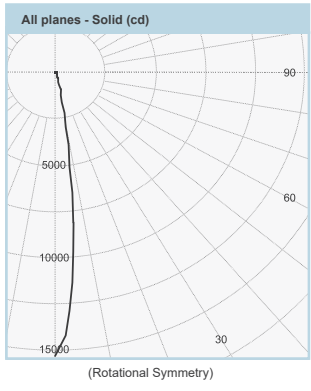
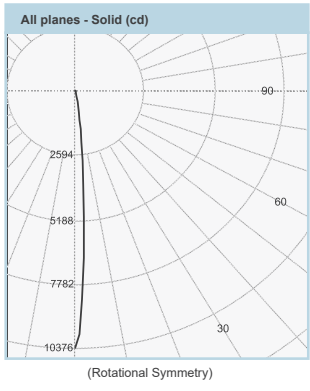

Project Name:		Type:	
Catalog Number:		Date:	

### Clarté Lighting 3000K 80+ CRI Color Metrics

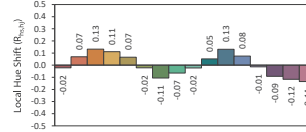
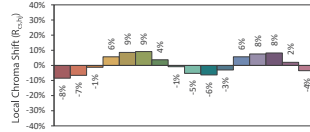
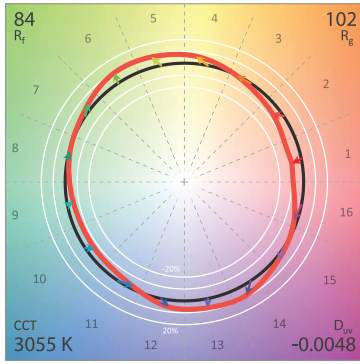

CIE 13.3-1995 (CRI)  
R<sub>a</sub> 86  
R<sub>9</sub> 29

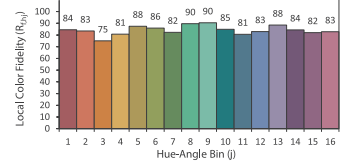
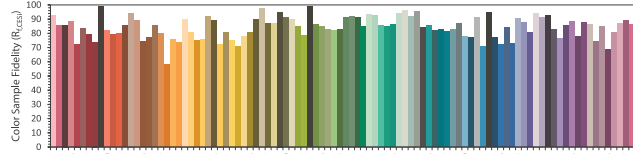

### Clarté Lighting 3000K 90+ CRI Color Metrics

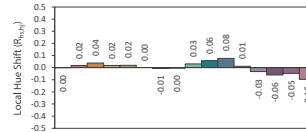
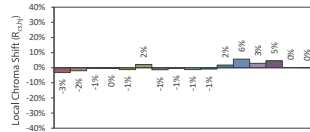
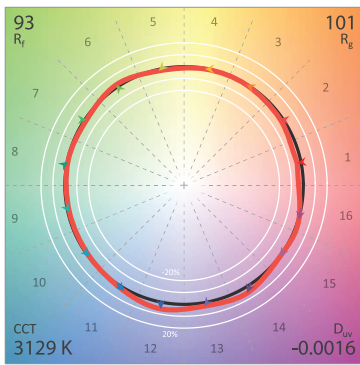

CIE 13.3-1995 (CRI)  
R<sub>a</sub> 95  
R<sub>9</sub> 74

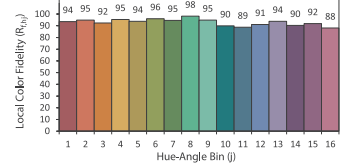
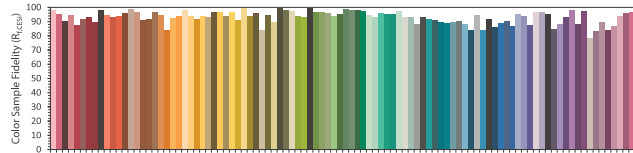

### Clarté Lighting 3000K 90+ CRI Halogen Lens (H) Color Metrics

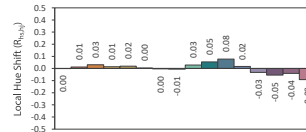
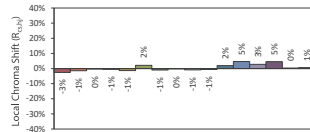
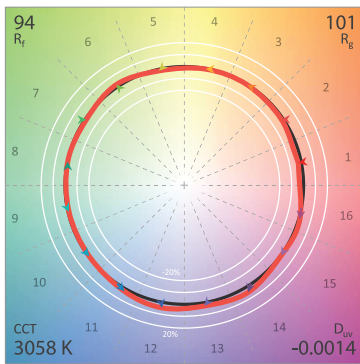

CIE 13.3-1995 (CRI)  
R<sub>a</sub> 96  
R<sub>9</sub> 79

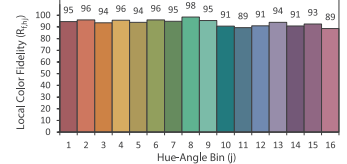
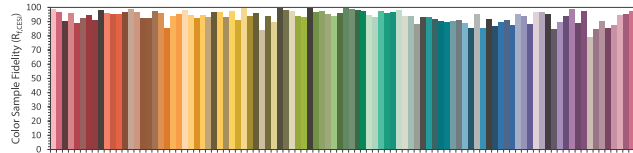

### Clarté Lighting 3000K 90+ CRI Dimmed Halogen Lens (DH) Color Metrics

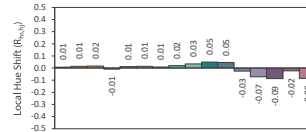
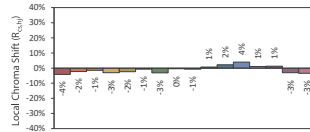
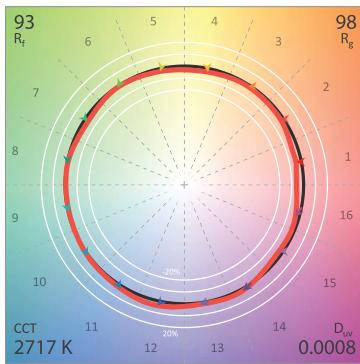

CIE 13.3-1995 (CRI)  
R<sub>a</sub> 95  
R<sub>9</sub> 64

