

# SMS2-201-PAR16-ADJ-FIX

2-Lamp Adjustable/Fixed

|                 |  |       |  |
|-----------------|--|-------|--|
| Project Name:   |  | Type: |  |
| Catalog Number: |  | Date: |  |

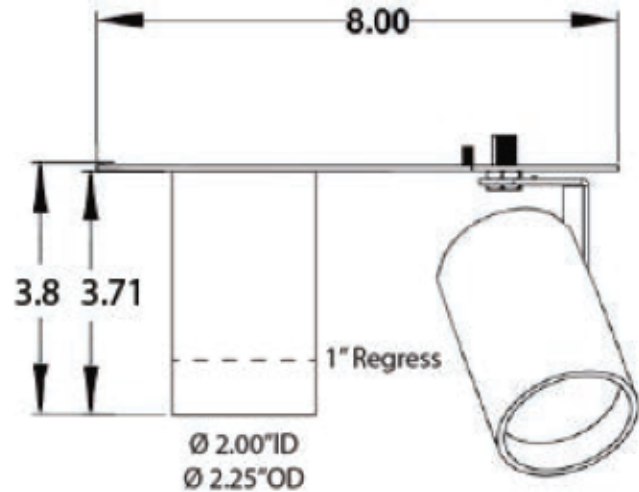
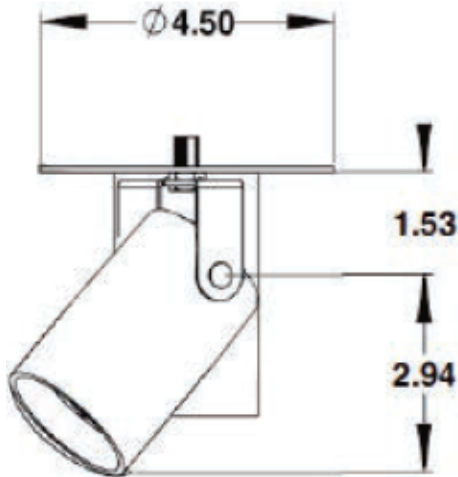

### Key Features

- 2.25" OD
- Up to 4 accessories
- Remote transformer option
- Over 10,000+ fixture custom color finish options
- 100,000+ hr L70 life
- See Page 3 for additional mounting options

### LED Source Details

- CREE XPL LED maximum rating = 3,000mA
- Fixture operating milliamp range = 450mA to 1150mA.
  - Operating 15% to 38% of rated value
  - Fixture wattage range = 8W to 20W
  - Fixture delivered lumens = 700 to 1,300 lumens

Last revised: 01/24/2024

# SMS2-201-PAR16-ADJ-FIX

2-Lamp Adjustable/Fixed

|                 |  |       |  |
|-----------------|--|-------|--|
| Project Name:   |  | Type: |  |
| Catalog Number: |  | Date: |  |

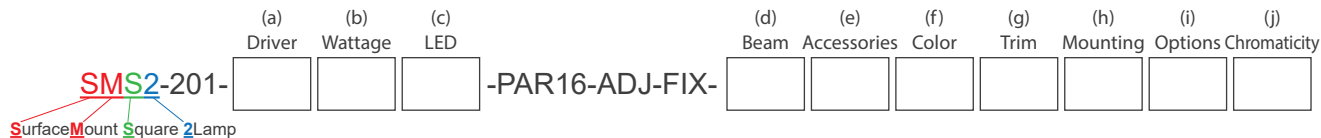

**(a) Driver Options**

- E = ON/OFF (Electronic)
- D\* = MLV 1% Dimming (2 wire)
- DC12V = .01% PWM DC dimming (2 wire)
- DC24V = .01% PWM DC dimming (2 wire)
- ED = Electronic Reverse Phase Dimming 1% (2 wire)
- DALI2 = .01% Digital Addressable Lighting Interface V2
- 0-10V\*\* = Remote mount 4 wire 0-10V LED driver single fixture
- 0-10V 2 = Remote mount 4 wire 0-10V driver for up to 2 fixtures
- 0-10V 3 = Remote mount 4 wire 0-10V driver for up to 3 fixtures
- 0-10V 4\*\*\* = Remote mount 4 wire 0-10V driver for up to 4 fixtures
- 0-10V MRI\*\*\*\* = 0-10V Dimming with 100bd Filter
- RDM DMX = 16 Bit, 4 Channel (2 wire with CAT5)
- ABS = Absolute Light .001% Dimming (use with RGBW)
- ABSX = DMX Absolute Light .001% RGBW dimming

\*MLV power supply is intended for use with forward phase SCR or Triac dimmers.  
 \*\*Do not use with relays or toggle switches, do not use with reverse phase dimmers.  
 \*\*\*Remote single 0-10V LED driver up to 18' away 18ga and 50' away 12ga  
 \*\*\*\*Remote 0-10V LED driver operates up to 4 fixtures up to 18' away 18ga and 50' away 12ga  
 \*\*\*\*\*Operates up to 4 recessed LED light fixtures for MRI room installation with remote LED driver

**(b) Wattage Options**

- 9W (520 Lumens) = MLV <1% Dimming
  - 14W (800 Lumens) = MLV <1% Dimming
  - 17W (1100 Lumens) = MLV <1% Dimming
- Can be used with Remote or In-Line 12V Transformer
- 12W (800 Lumens) = ON/OFF, 0-10V 1%, ED
  - 16W (1100 Lumens) = ON/OFF, 0-10V 1%, ED
  - 18W (900 Lumens) = Absolute Light RGBW
  - 19W (1300 Lumens) = DMX Dimming
  - 20W (1300 Lumens) = ON/OFF, 0-10V 1%, ED
- To be used ONLY with Remote Transformer







**(c) LED Type Options**

XLED = Cree XPL2 LED @ All Wattages

**(d) Beam Options**

- NSP = Narrow Spot                      NFL = Narrow Flood
- SP = Spot                                      FL = Flood

**(e) Optical and Accessory Options**

- LS = Lens Softener - +20% increase in beam width. Shields optical face visually. Softens edges of beam. 
- LSL = Linear Spread Lens - Horizontal or vertical beam elongation. 
- WFL = Wide Flood Lens - Wall washing increases the beam by 50% width with elimination of center beam. 
- LV = Louver - Hexcel louver eliminates all surface brightness. Creates stronger vertical cut off with -20% beam width. 
- CHL = Cross Hair Louver 
- H = Halogen - 150K warmer. 2700k to 2550K 
- DH = Dimmed Halogen - 300K warmer. 2700k to 2400K 

**(f) Fixture Color Options**

- BLK = Black
  - WHT = White
  - PWT = Pewter
- Select Custom Color (Review Website for Over 3,300 Color Options)

**(g) Trim Type**

- T = Trim
- LP = Level Plane
- TL = Trimless

**(h) Mounting Options**

- NC = New Construction
- RMT = Remote Transformer

**(i) Options**

- RMT60 = 14 watt 12V AC MLV Step Down Transformer
- RMT60 = 60 watt 12V AC MLV Step Down Transformer
- RMT150 = 150 watt 12V AC MLV Step Down Transformer
- RMT300 = 300 watt 12V AC MLV Step Down Transformer
- 12V = Up to 6 Fixtures - Add 12V AC Magnetic Step Down Transformer to Operate Track
- 24V = Up to 10 Fixtures - Add 24V AC Magnetic Step Down Transformer to Operate Track
- 120V = 120VAC 60Hz (Standard)
- 230V = 230VAC 50Hz (Used in conjunction with 230V track)
- 277V = 277VAC 60Hz (Used in conjunction with 277V track)
- EMG = 90 Minute Emergency Battery Backup
- 80+ = CRI over 80
- 90+ = CRI over 90
- IPS = 5/8" Threaded Rod Nipple to Mount to Unistrut or Other Flat Surfaces
- DMX\* = .39% to 100% milliamp constant voltage LED driver, dip switch addressable, 3 channel for 27K & 30K, 4 channel for RGBW, CAT5 in & out\*

\*DMX is required in RGBW or in any 2 circuits or more.  
 Custom colors available - Consult factory for more details

**(j) Color Temperature Options**

- |  |                                      |
|--|--------------------------------------|
| <b>White LED</b>                       | <b>Colored/Themed LED</b>            |
| 22K* = 2200 Kelvin (candlelight color) | UV275** = 275 NM UV virus sterilizer |
| 27K = 2700 Kelvin (incandescent color) | UV365*** = 365 NM UV black light     |
| 30K = 3000 Kelvin (halogen color)      | UV390*** = 390 NM UV black light     |
| 35K = 3500 Kelvin (warm incandescent)  | Blue*** = 465 - 485 NM wavelength    |
| 40K = 4000 Kelvin (cool incandescent)  | Green*** = 520 - 535 NM wavelength   |
| 50K = 5000 Kelvin (day white)          | Amber*** = 585 - 595NM wavelength    |
| 65K = 6500 Kelvin (12 noon sunlight)   | Red*** = 620 - 630 NM wavelength     |
|  | RGBW3K**** = Red, Green, Blue, White |
|  | RGBW4K**** = Red, Green, Blue, White |

\*1050 mA or less

\*\*500 mA  
 \*\*\*700 mA  
 \*\*\*\*Must utilize DMX @ 700 mA

**SMS2-201-PAR16-ADJ-FIX**

2-Lamp Adjustable/Fixed

|                 |  |       |  |
|-----------------|--|-------|--|
| Project Name:   |  | Type: |  |
| Catalog Number: |  | Date: |  |

New Construction

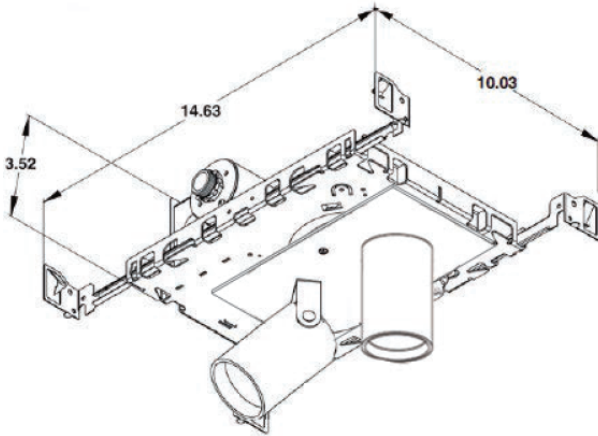
**Housing**

- 100% aluminum construction

**Electrical**

- Optional - 12V AC remote class 2
- 100V, 120V, 230V, 277V or 347V

**LED**

- 3,000mA maximum rated CREE XPL2 LED
- Operates between 450 to 1200mA
- 15% to 40% of rated mA

**LED Driver**

- D – 2 wire forward phase .01% LED driver fade to off glow to on
- ED – 2 wire reverse phase 1% LED driver
- DC – 12V or 24V

**Optics**

- TIR discrete injection molded polycarbonate precision LED optic
- 45-degree vertical cut off

**Installation**

- IPS Nipple - Unistrut (Not provided)

**Certification**

- UL Damp Listed – IP 52

**Warranty**

- 5 Year – ED, 0-10V, DMX and colored LED fixtures
- 7 Year – D and White LED fixtures

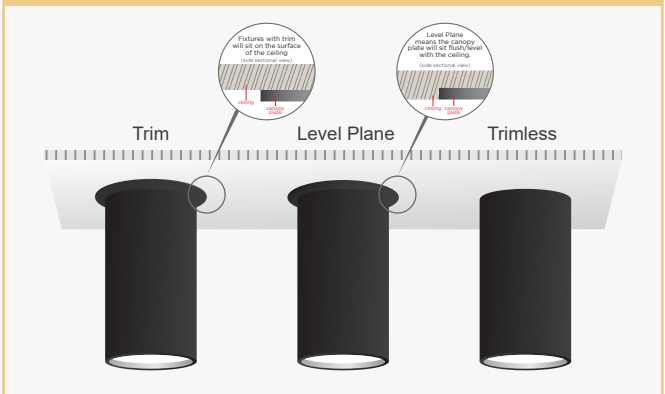
**3 Trim Installation Options**

# SMS2-201-PAR16-ADJ-FIX

2-Lamp Adjustable/Fixed

|                 |  |       |  |
|-----------------|--|-------|--|
| Project Name:   |  | Type: |  |
| Catalog Number: |  | Date: |  |

### Narrow Narrow Spot 8.5°

|       |          |      |
|-------|----------|------|
| 3.3'  | 1,028 fc | 0.5' |
| 6.7'  | 249 fc   | 1.0' |
| 10'   | 112 fc   | 1.5' |
| 13.3' | 63.3 fc  | 2.0' |
| 16.7' | 40.1 fc  | 2.5' |
| 20'   | 28 fc    | 3.0' |
| 26.7' | 15.7 fc  | 4.0' |
| 33.3' | 10.1 fc  | 5.0' |
| 40'   | 7 fc     | 6.0' |

20W PAR16 - 472 lm  
11,195 CBCP

### Zonal Flux and Percentages

| Zone   | Flux (lm) | %Luminaire |
|--------|-----------|------------|
| 0-30   | 460       | 97.5       |
| 0-40   | 467       | 99.0       |
| 0-60   | 472       | 100.0      |
| 0-90   | 472       | 100.0      |
| 40-70  | 5         | 1.0        |
| 60-80  | 0         | 0.0        |
| 90-180 | 0         | 0.0        |
| 0-180  | 472       | 100.0      |

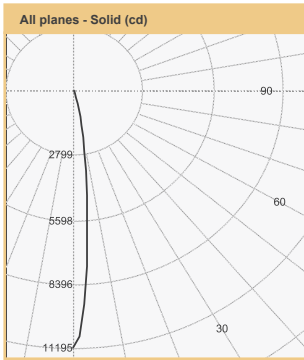

### Narrow Narrow Spot 7.9° (with Louver)

|       |         |      |
|-------|---------|------|
| 3.3'  | 953 fc  | 0.5' |
| 6.7'  | 231 fc  | 0.9' |
| 10'   | 104 fc  | 1.4' |
| 13.3' | 58.7 fc | 1.8' |
| 16.7' | 37.2 fc | 2.3' |
| 20'   | 25.9 fc | 2.8' |
| 26.7' | 14.6 fc | 3.7' |
| 33.3' | 9.36 fc | 4.6' |
| 40'   | 6.48 fc | 5.5' |

20W PAR16 - 382 lm  
10,376 CBCP

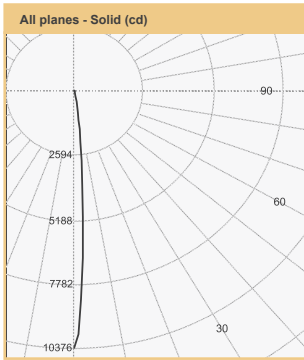

### Wattage & Lumen Output

|                                     |                                     |
|-------------------------------------|-------------------------------------|
| <b>450 Milliamps - 520 Lumens</b>   | <b>700 Milliamps - 800 Lumens</b>   |
| 8W ON/OFF                           | 12W ON/OFF                          |
| 0-10V 1% Dimming                    | 0-10V 1% Dimming                    |
| 9W MLV <1% Dimming                  | ELV 10% Dimming                     |
|                                     | 14W MLV <1% Dimming                 |
| <b>1000 Milliamps - 1100 Lumens</b> | <b>1150 Milliamps - 1300 Lumens</b> |
| 16W ON/OFF                          | 20W ON/OFF                          |
| 0-10V 1% Dimming                    | 0-10V 1% Dimming                    |
| ELV 10% Dimming                     | ELV 10% Dimming                     |
| 17W MLV <1% Dimming                 |                                     |
| 19W Lutron 1% Dimming               |                                     |
| DMX .33% Dimming                    |                                     |

### 3 Step CREE XPL2 LED

| Kelvin-CRI   | Multiplier |
|--------------|------------|
| 27K-80+ CRI  | 1          |
| 27K-90+ CRI  | 0.80       |
| 30K-80+ CRI  | 1          |
| 30K-90+ CRI  | 0.85       |
| 35K-80+ CRI  | 105        |
| 35K-90+ CRI  | 0.9        |
| 40K-80+ CRI  | 109        |
| 50K-80+ CRI  | 109        |
| 65K-80+ CRI  | 105        |
| 80+ = 84 CRI |            |
| 90+ = 94 CRI |            |

### RGBW V2 Light Output Luminous Flux

Clarté Lighting offers 100% of fixtures in optional RGBW3K or RGBW4K

|              | 700 mA RGBW3K | 700 mA White 3K |
|--------------|---------------|-----------------|
| Red          | 160           |                 |
| Green        | 310           |                 |
| Blue         | 46            |                 |
| White        | 260           |                 |
| <b>Total</b> | <b>776</b>    | <b>970</b>      |

\*RGBW Fixtures are designed to not operate with all 4 colors at 100% of light for more than 24hrs continuously and suggest operating 55% or less of all 4 colors ON to ensure optimum thermal life of the RGBW LED.

### Narrow Spot 12°

|     |          |       |
|-----|----------|-------|
| 2'  | 3,824 fc | 0.4'  |
| 4'  | 956 fc   | 0.9'  |
| 6'  | 425 fc   | 1.3'  |
| 8'  | 239 fc   | 1.8'  |
| 10' | 153 fc   | 2.2'  |
| 12' | 106 fc   | 2.7'  |
| 20' | 28 fc    | 5.2'  |
| 26' | 16 fc    | 7.0'  |
| 33' | 10 fc    | 8.7'  |
| 40' | 7 fc     | 10.5' |

20W PAR16 - 1,100 lm  
15,296 CBCP

### Intensity Summary (cd)

| Gamma | All Planes | Flux (lm) |
|-------|------------|-----------|
| 0     | 15296      |           |
| 5     | 9739       | 696       |
| 10    | 2978       |           |
| 15    | 676        | 236       |
| 20    | 229        |           |
| 25    | 135        | 64        |
| 30    | 90         |           |
| 35    | 67         | 43        |
| 40    | 53         |           |
| 45    | 46         | 35        |
| 50    | 34         |           |
| 55    | 23         | 21        |
| 60    | 15         |           |
| 65    | 2          | 4         |
| 70    | 1          |           |
| 75    | 0          | 0         |
| 80    | 0          |           |
| 85    | 0          | 0         |
| 90    | 0          |           |

### Zonal Flux and Percentages

| Zone   | Flux (lm) | %Luminaire |
|--------|-----------|------------|
| 0-30   | 997       | 90.6       |
| 0-40   | 1040      | 94.6       |
| 0-60   | 1096      | 99.6       |
| 0-90   | 1100      | 100.0      |
| 40-90  | 60        | 5.4        |
| 60-90  | 4         | 0.4        |
| 90-180 | 0         | 0.0        |
| 0-180  | 1100      | 100.0      |

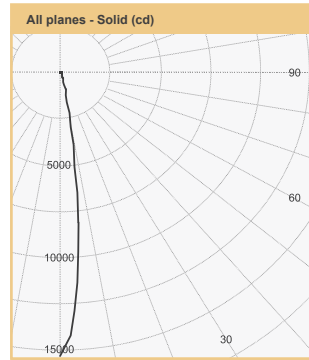

### Spot 19°

|     |          |       |
|-----|----------|-------|
| 2'  | 1,939 fc | 0.7'  |
| 4'  | 485 fc   | 1.4'  |
| 6'  | 215 fc   | 2.0'  |
| 8'  | 121 fc   | 2.7'  |
| 10' | 78 fc    | 3.4'  |
| 12' | 54 fc    | 4.1'  |
| 20' | 28 fc    | 6.1'  |
| 26' | 16 fc    | 8.1'  |
| 33' | 10 fc    | 10.1' |
| 40' | 7 fc     | 12.1' |

20W PAR16 - 1,313 lm  
7,757 CBCP

### Intensity Summary (cd)

| Gamma | All Planes | Flux (lm) |
|-------|------------|-----------|
| 0     | 7757       |           |
| 5     | 6432       | 519       |
| 10    | 3640       |           |
| 15    | 1648       | 475       |
| 20    | 731        |           |
| 25    | 336        | 166       |
| 30    | 176        |           |
| 35    | 110        | 71        |
| 40    | 77         |           |
| 45    | 67         | 50        |
| 50    | 47         |           |
| 55    | 29         | 26        |
| 60    | 15         |           |
| 65    | 3          | 5         |
| 70    | 1          |           |
| 75    | 0          | 1         |
| 80    | 0          |           |
| 85    | 0          | 0         |
| 90    | 0          |           |

### Zonal Flux and Percentages

| Zone   | Flux (lm) | %Luminaire |
|--------|-----------|------------|
| 0-30   | 1160      | 88.3       |
| 0-40   | 1231      | 93.8       |
| 0-60   | 1308      | 99.6       |
| 0-90   | 1313      | 100.0      |
| 40-90  | 82        | 6.2        |
| 60-90  | 5         | 0.4        |
| 90-180 | 0         | 0.0        |
| 0-180  | 1313      | 100.0      |

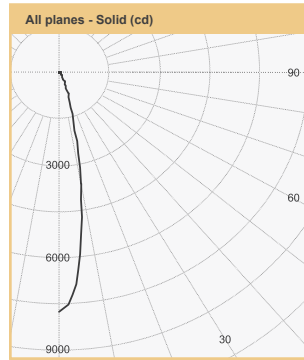

### Narrow Flood 24°

|     |          |       |
|-----|----------|-------|
| 2'  | 1,705 fc | 0.7'  |
| 4'  | 426 fc   | 1.4'  |
| 6'  | 189 fc   | 2.1'  |
| 8'  | 107 fc   | 2.8'  |
| 10' | 68 fc    | 3.5'  |
| 12' | 47 fc    | 4.3'  |
| 20' | 17 fc    | 7.5'  |
| 26' | 10 fc    | 10.0' |
| 33' | 6 fc     | 12.4' |
| 40' | 5 fc     | 14.9' |

20W PAR16 - 1,306 lm  
5,478 CBCP

### Intensity Summary (cd)

| Gamma | All Planes | Flux (lm) |
|-------|------------|-----------|
| 0     | 5478       |           |
| 5     | 4774       | 404       |
| 10    | 3229       |           |
| 15    | 1800       | 500       |
| 20    | 905        |           |
| 25    | 452        | 219       |
| 30    | 244        |           |
| 35    | 146        | 95        |
| 40    | 98         |           |
| 45    | 75         | 57        |
| 50    | 47         |           |
| 55    | 25         | 25        |
| 60    | 15         |           |
| 65    | 3          | 5         |
| 70    | 1          |           |
| 75    | 1          | 1         |
| 80    | 0          |           |
| 85    | 0          | 0         |
| 90    | 0          |           |

### Zonal Flux and Percentages

| Zone   | Flux (lm) | %Luminaire |
|--------|-----------|------------|
| 0-30   | 1123      | 86.0       |
| 0-40   | 1219      | 93.3       |
| 0-60   | 1301      | 99.6       |
| 0-90   | 1306      | 100.0      |
| 40-90  | 88        | 6.7        |
| 60-90  | 6         | 0.4        |
| 90-180 | 0         | 0.0        |
| 0-180  | 1306      | 100.0      |

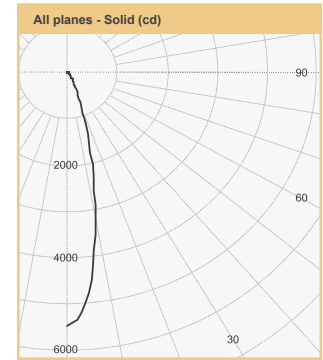

# SMS2-201-PAR16-ADJ-FIX

2-Lamp Adjustable/Fixed

|                 |  |       |  |
|-----------------|--|-------|--|
| Project Name:   |  | Type: |  |
| Catalog Number: |  | Date: |  |

## Clarté Lighting 3000K 80+ CRI Color Metrics

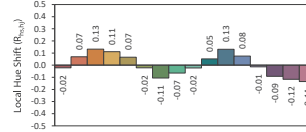
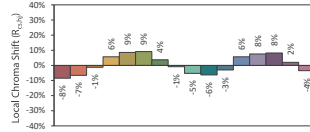
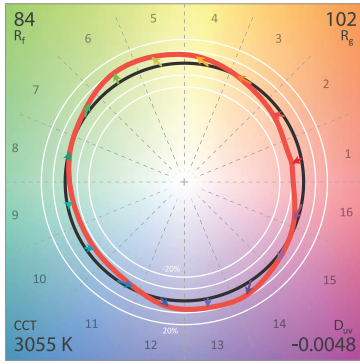

CIE 13.3-1995 (CRI)  
 $R_a$  86  
 $R_g$  29

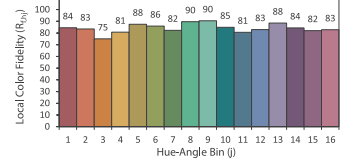
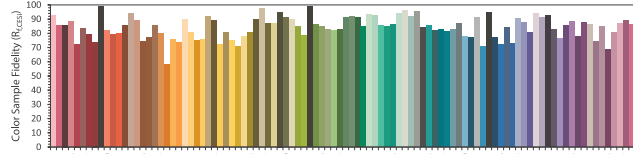

## Clarté Lighting 3000K 90+ CRI Color Metrics

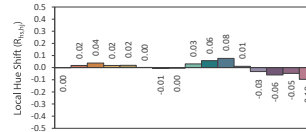
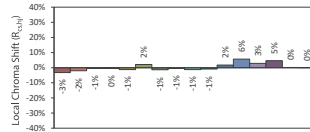
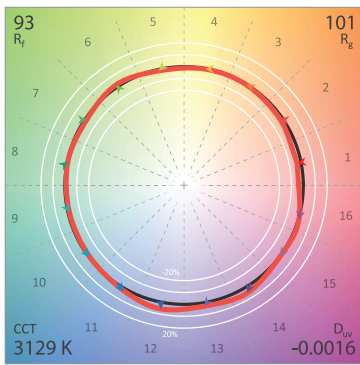

CIE 13.3-1995 (CRI)  
 $R_a$  95  
 $R_g$  74

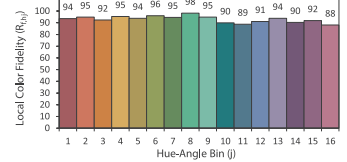
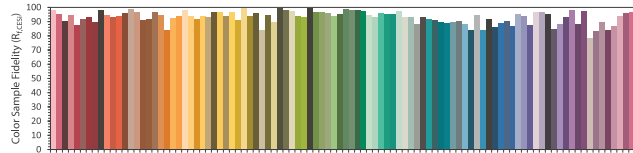

## Clarté Lighting 3000K 90+ CRI Halogen Lens (H) Color Metrics

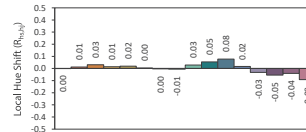
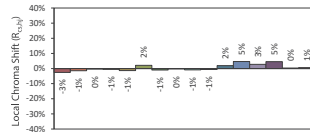
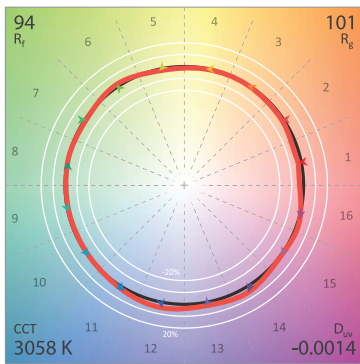

CIE 13.3-1995 (CRI)  
 $R_a$  96  
 $R_g$  79

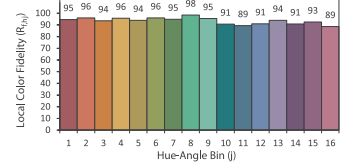
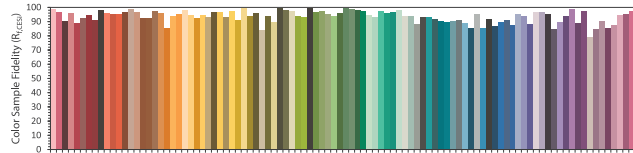

## Clarté Lighting 3000K 90+ CRI Dimmed Halogen Lens (DH) Color Metrics

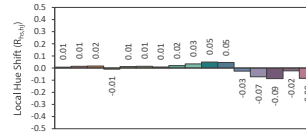
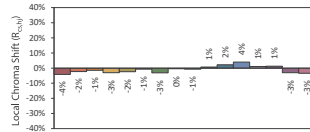
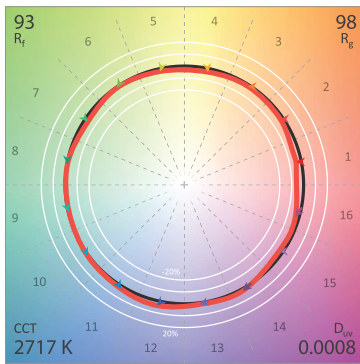

CIE 13.3-1995 (CRI)  
 $R_a$  95  
 $R_g$  64

