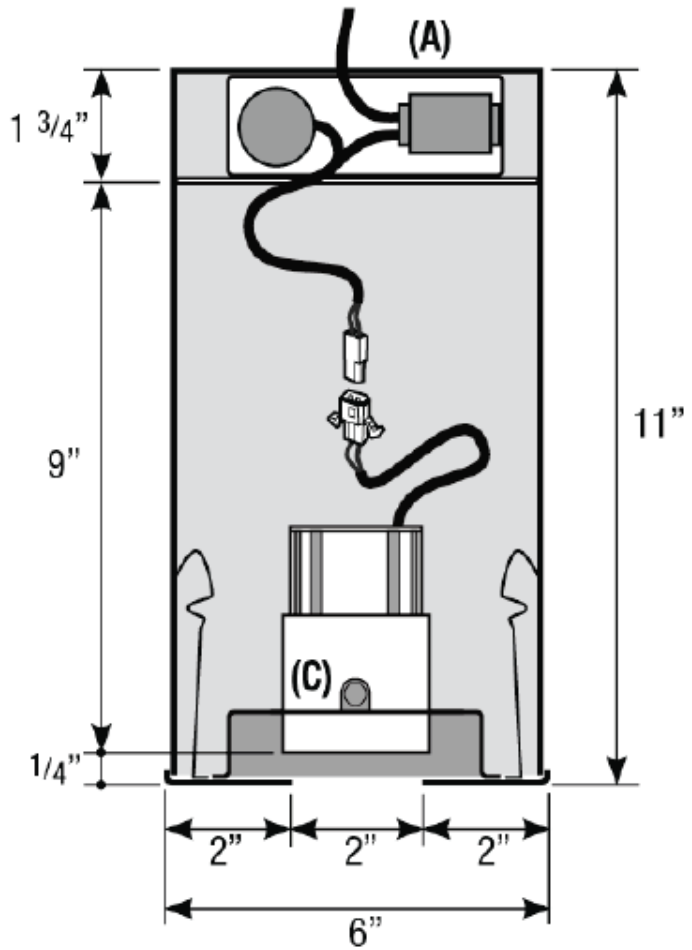

**SR6-646-PAR16**

6" Dia. Surface Mounted Cylinder - Pinhole

Project Name:		Type:	
Catalog Number:		Date:	

**Key Features**

- 6" OD
- Up to 4 accessories
- Remote transformer option
- Over 10,000+ fixture custom color finish options
- 100,000+ hr L70 life
- **See Page 3 for additional mounting options**

**LED Source Details**

CREE XPL LED maximum rating = 3,000mA

- Fixture operating milliamp range = 450mA to 1150mA.
- Operating 15% to 38% of rated value
- Fixture wattage range = 8W to 20W
- Fixture delivered lumens = 700 to 1,300 lumens

Last revised: 01/24/2024

# SR6-646-PAR16

6" Dia. Surface Mounted Cylinder - Pinhole

Project Name:		Type:	
Catalog Number:		Date:	

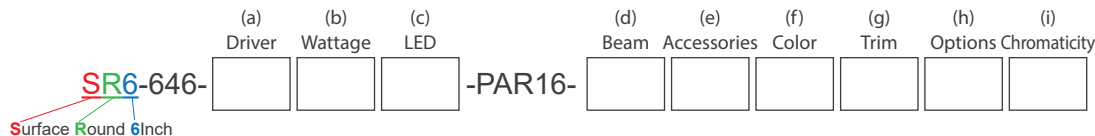

**(a) Driver Options**

- E = ON/OFF (Electronic)
- D\* = MLV 1% Dimming (2 wire)
- DC12V = .01% PWM DC dimming (2 wire)
- DC24V = .01% PWM DC dimming (2 wire)
- ED = Electronic Reverse Phase Dimming 1% (2 wire)
- DALI2 = .01% Digital Addressable Lighting Interface V2
- 0-10V\*\* = Remote mount 4 wire 0-10V LED driver single fixture
- 0-10V 2 = Remote mount 4 wire 0-10V driver for up to 2 fixtures
- 0-10V 3 = Remote mount 4 wire 0-10V driver for up to 3 fixtures
- 0-10V 4\*\*\* = Remote mount 4 wire 0-10V driver for up to 4 fixtures
- 0-10V MRI\*\*\*\* = 0-10V Dimming with 100bd Filter
- RDM DMX = 16 Bit, 4 Channel (2 wire with CAT5)
- ABS = Absolute Light .001% Dimming (use with RGBW)
- ABSX = DMX Absolute Light .001% RGBW dimming

\*MLV power supply is intended for use with forward phase SCR or Triac dimmers.  
 \*Do not use with relays or toggle switches, do not use with reverse phase dimmers.  
 \*\*Remote single 0-10V LED driver up to 18' away 18ga and 50' away 12ga  
 \*\*\*Remote 0-10V LED driver operates up to 4 fixtures up to 18' away 18ga and 50' away 12ga  
 \*\*\*\*Operates up to 4 recessed LED light fixtures for MRI room installation with remote LED driver

**(b) Wattage Options**

- 9W (520 Lumens) = MLV <1% Dimming
  - 14W (800 Lumens) = MLV <1% Dimming
  - 17W (1100 Lumens) = MLV <1% Dimming
- Can be used with Remote or In-Line 12V Transformer
- 12W (800 Lumens) = ON/OFF, 0-10V 1%, ED
  - 16W (1100 Lumens) = ON/OFF, 0-10V 1%, ED
  - 18W (900 Lumens) = Absolute Light RGBW
  - 19W (1300 Lumens) = DMX Dimming
  - 20W (1300 Lumens) = ON/OFF, 0-10V 1%, ED
- To be used ONLY with Remote Transformer

**(c) LED Type Options**

XLED = Cree XPL2 LED @ All Wattages

**(d) Beam Options**

- NSP = Narrow Spot
- SP = Spot
- NFL = Narrow Flood
- FL = Flood

**(e) Optical and Accessory Options**

- LS = Lens Softener - +20% increase in beam width. Shields optical face visually. Softens edges of beam.
- LSL = Linear Spread Lens - Horizontal or vertical beam elongation.
- WFL = Wide Flood Lens - Wall washing increases the beam by 50% width with elimination of center beam.
- LV = Louver - Hexcel louver eliminates all surface brightness. Creates stronger vertical cut off with -20% beam width.
- CHL = Cross Hair Louver
- H = Halogen - 150K warmer. 2700k to 2550K
- DH = Dimmed Halogen - 300K warmer. 2700k to 2400K

**(f) Fixture Color Options**

- BLK = Black
  - WHT = White
  - PWT = Pewter
- Select Custom Color (Review Website for Over 3,300 Color Options)

**(g) Trim Type**

- OT = Oval Trim
- ST = Shallow Trim
- DT = Deep Trim

**(h) Options**

- BTS = Black Tapered Snoot
- WTS = White Tapered Snoot
- WBTS = White Exterior / Black Interior
- WWSN = Wall Wash Snoot
- 80+ = CRI over 80
- 90+ = CRI over 90
- RMT60 = 60 watt 12V AC MLV Step Down Transformer
- RMT150 = 150 watt 12V AC MLV Step Down Transformer
- RMT300 = 300 watt 12V AC MLV Step Down Transformer
- 12V = Up to 6 Fixtures - Add 12V AC Magnetic Step Down Transformer to Operate Track
- 24V = Up to 10 Fixtures - Add 24V AC Magnetic Step Down Transformer to Operate Track
- 120V = 120VAC 60Hz (Standard)
- 230V = 230VAC 50Hz (Used in conjunction with 230V track)
- 277V = 277VAC 60Hz (Used in conjunction with 277V track)
- 347V = 347VAC 60Hz
- BJ = Ball Joint (For Sloped Ceiling)
- FCP = Flat Canopy Plate
- IPS = 5/8" Threaded Rod Nipple to Mount to Unistrut or Other Flat Surfaces
- DMX\* = .39% to 100% milliamp constant voltage LED driver, dip switch addressable, 3 channel for 27K & 30K, 4 channel for RGBW, CAT5 in & out\*

\*DMX is required in RGBW or in any 2 circuits or more.  
 Custom colors available - Consult factory for more details

**(i) Color Temperature Options**

- | White LED                              | Colored/Themed LED                   |
|--|--------------------------------------|
| 22K* = 2200 Kelvin (candlelight color) | UV275** = 275 NM UV virus sterilizer |
| 27K = 2700 Kelvin (incandescent color) | UV365*** = 365 NM UV black light     |
| 30K = 3000 Kelvin (halogen color)      | UV390**** = 390 NM UV black light    |
| 35K = 3500 Kelvin (warm incandescent)  | Blue*** = 465 - 485 NM wavelength    |
| 40K = 4000 Kelvin (cool incandescent)  | Green*** = 520 - 535 NM wavelength   |
| 50K = 5000 Kelvin (day white)          | Amber*** = 585 - 595NM wavelength    |
| 65K = 6500 Kelvin (12 noon sunlight)   | Red*** = 620 - 630 NM wavelength     |
|  | RGBW3K**** = Red, Green, Blue, White |
|  | RGBW4K**** = Red, Green, Blue, White |
- \*1050 mA or less      \*\*500 mA  
 \*\*\*700 mA  
 \*\*\*\*Must utilize DMX @ 700 mA

**SR6-646-PAR16**

6" Dia. Surface Mounted Cylinder - Pinhole

Project Name:		Type:	
Catalog Number:		Date:	

## Tapered Snoot

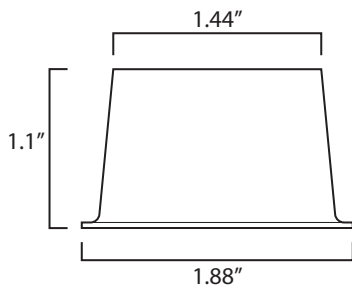
**Housing**

- 100% aluminum construction

**Electrical**

- Optional - 12V AC remote class 2
- 100V, 120V, 230V, 277V or 347V

**LED**

- 3,000mA maximum rated CREE XPL2 LED
- Operates between 450 to 1200mA
- 15% to 40% of rated mA

**LED Driver**

- D – 2 wire forward phase .01% LED driver fade to off glow to on
- ED – 2 wire reverse phase 1% LED driver
- DC – 12V or 24V

**Optics**

- TIR discrete injection molded polycarbonate precision LED optic
- 45-degree vertical cut off

**Installation**

- IPS Nipple - Unistrut (Not provided)

**Certification**

- UL Damp Listed – IP 52

**Warranty**

- 5 Year – ED, 0-10V, DMX and colored LED fixtures
- 7 Year – D and White LED fixtures

# SR6-646-PAR16

6" Dia. Surface Mounted Cylinder - Pinhole

Project Name:		Type:	
Catalog Number:		Date:	

### Narrow Narrow Spot 8.5°

3.3'	1,028 fc	0.5'
6.7'	249 fc	1.0'
10'	112 fc	1.5'
13.3'	63.3 fc	2.0'
16.7'	40.1 fc	2.5'
20'	28 fc	3.0'
26.7'	15.7 fc	4.0'
33.3'	10.1 fc	5.0'
40'	7 fc	6.0'

20W PAR16 - 472 lm  
11,195 CBCP

### Wattage & Lumen Output

<b>450 Milliamps - 520 Lumens</b>	<b>700 Milliamps - 800 Lumens</b>
8W ON/OFF	12W ON/OFF
0-10V 1% Dimming	0-10V 1% Dimming
9W MLV <1% Dimming	ELV 10% Dimming
	14W MLV <1% Dimming
<b>1000 Milliamps - 1100 Lumens</b>	<b>1150 Milliamps - 1300 Lumens</b>
16W ON/OFF	20W ON/OFF
0-10V 1% Dimming	0-10V 1% Dimming
ELV 10% Dimming	ELV 10% Dimming
17W MLV <1% Dimming	
19W Lutron 1% Dimming	
DMX .33% Dimming	

### 3 Step CREE XPL2 LED

Kelvin-CRI	Multiplier
27K-80+ CRI	1
27K-90+ CRI	0.80
30K-80+ CRI	1
30K-90+ CRI	0.85
35K-80+ CRI	105
35K-90+ CRI	0.9
40K-80+ CRI	109
50K-80+ CRI	109
65K-80+ CRI	105
80+ = 84 CRI	
90+ = 94 CRI	

### RGBW V2 Light Output Luminous Flux

Clarté Lighting offers 100% of fixtures in optional RGBW3K or RGBW4K

	700 mA RGBW3K	700 mA White 3K
Red	160	
Green	310	
Blue	46	
White	260	
<b>Total</b>	<b>776</b>	<b>970</b>

\*RGBW Fixtures are designed to not operate with all 4 colors at 100% of light for more than 24hrs continuously and suggest operating 55% or less of all 4 colors ON to ensure optimum thermal life of the RGBW LED.

### Zonal Flux and Percentages

Zone	Flux (lm)	%Luminaire
0-30	460	97.5
0-40	467	99.0
0-60	472	100.0
0-90	472	100.0
40-70	5	1.0
60-80	0	0.0
90-180	0	0.0
0-180	472	100.0

### Narrow Spot 12°

2'	3,824 fc	0.4'
4'	956 fc	0.9'
6'	425 fc	1.3'
8'	239 fc	1.8'
10'	153 fc	2.2'
12'	106 fc	2.7'
20'	28 fc	5.2'
26'	16 fc	7.0'
33'	10 fc	8.7'
40'	7 fc	10.5'

20W PAR16 - 1,100 lm  
15,296 CBCP

### Spot 19°

2'	1,939 fc	0.7'
4'	485 fc	1.4'
6'	215 fc	2.0'
8'	121 fc	2.7'
10'	78 fc	3.4'
12'	54 fc	4.1'
20'	28 fc	6.1'
26'	16 fc	8.1'
33'	10 fc	10.1'
40'	7 fc	12.1'

20W PAR16 - 1,313 lm  
7,757 CBCP

### Narrow Flood 24°

2'	1,705 fc	0.7'
4'	426 fc	1.4'
6'	189 fc	2.1'
8'	107 fc	2.8'
10'	68 fc	3.5'
12'	47 fc	4.3'
20'	17 fc	7.5'
26'	10 fc	10.0'
33'	6 fc	12.4'
40'	5 fc	14.9'

20W PAR16 - 1,306 lm  
5,478 CBCP

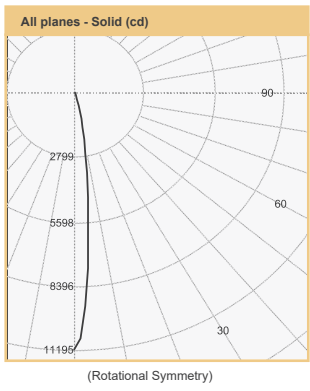

### Intensity Summary (cd)

Gamma	All Planes	Flux (lm)
0	15296	
5	9739	696
10	2978	
15	676	236
20	229	
25	135	64
30	90	
35	67	43
40	53	
45	46	35
50	34	
55	23	21
60	15	
65	2	4
70	1	
75	0	0
80	0	
85	0	0
90	0	

### Intensity Summary (cd)

Gamma	All Planes	Flux (lm)
0	7757	
5	6432	519
10	3640	
15	1648	475
20	731	
25	336	166
30	176	
35	110	71
40	77	
45	67	50
50	47	
55	29	26
60	15	
65	3	5
70	1	
75	0	1
80	0	
85	0	0
90	0	

### Intensity Summary (cd)

Gamma	All Planes	Flux (lm)
0	5478	
5	4774	404
10	3229	
15	1800	500
20	905	
25	452	219
30	244	
35	146	95
40	98	
45	75	57
50	47	
55	25	25
60	15	
65	3	5
70	1	
75	1	1
80	0	
85	0	0
90	0	

### Narrow Narrow Spot 7.9° (with Louver)

3.3'	953 fc	0.5'
6.7'	231 fc	0.9'
10'	104 fc	1.4'
13.3'	58.7 fc	1.8'
16.7'	37.2 fc	2.3'
20'	25.9 fc	2.8'
26.7'	14.6 fc	3.7'
33.3'	9.36 fc	4.6'
40'	6.48 fc	5.5'

20W PAR16 - 382 lm  
10,376 CBCP

### Zonal Flux and Percentages

Zone	Flux (lm)	%Luminaire
0-30	997	90.6
0-40	1040	94.6
0-60	1096	99.6
0-90	1100	100.0
40-90	60	5.4
60-90	4	0.4
90-180	0	0.0
0-180	1100	100.0

### Zonal Flux and Percentages

Zone	Flux (lm)	%Luminaire
0-30	1160	88.3
0-40	1231	93.8
0-60	1308	99.6
0-90	1313	100.0
40-90	82	6.2
60-90	5	0.4
90-180	0	0.0
0-180	1313	100.0

### Zonal Flux and Percentages

Zone	Flux (lm)	%Luminaire
0-30	1123	86.0
0-40	1219	93.3
0-60	1301	99.6
0-90	1306	100.0
40-90	88	6.7
60-90	6	0.4
90-180	0	0.0
0-180	1306	100.0

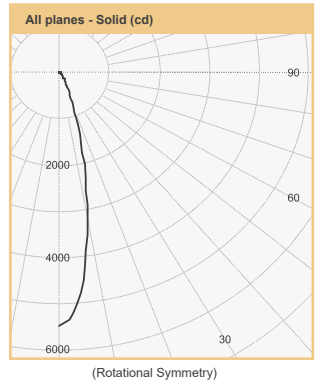
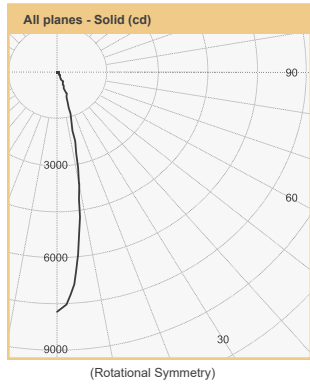
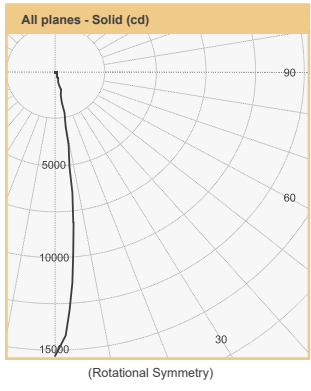
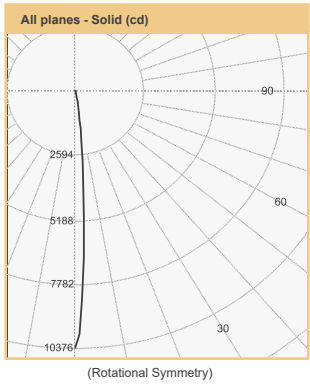

Project Name:		Type:	
Catalog Number:		Date:	

### Clarté Lighting 3000K 80+ CRI Color Metrics

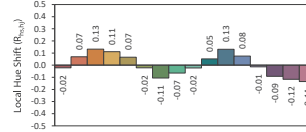
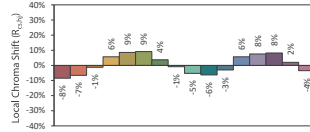
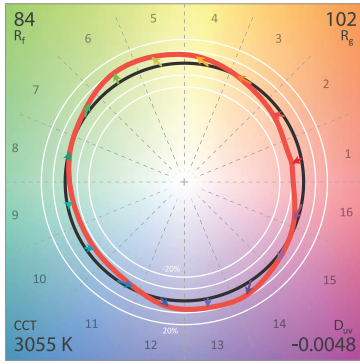

CIE 13.3-1995 (CRI)  
 $R_a$  86  
 $R_9$  29

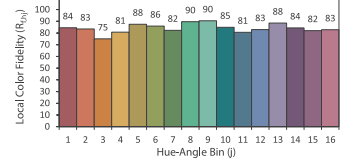
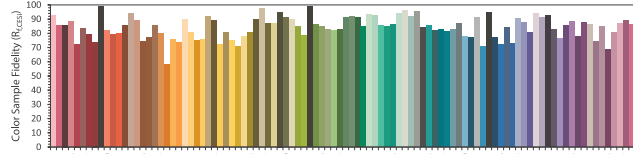

### Clarté Lighting 3000K 90+ CRI Color Metrics

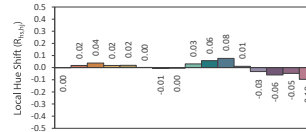
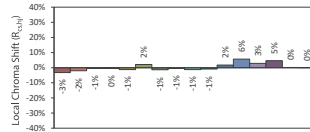
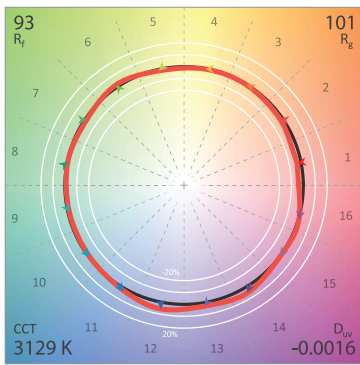

CIE 13.3-1995 (CRI)  
 $R_a$  95  
 $R_9$  74

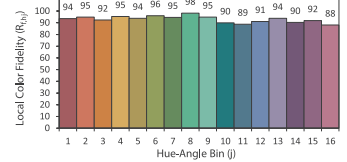
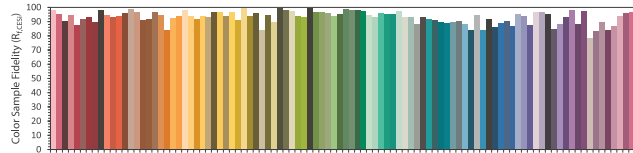

### Clarté Lighting 3000K 90+ CRI Halogen Lens (H) Color Metrics

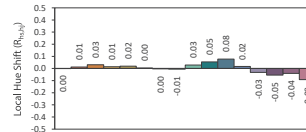
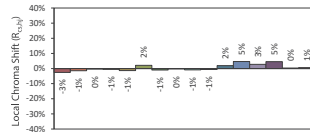
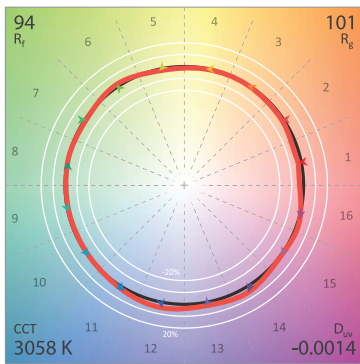

CIE 13.3-1995 (CRI)  
 $R_a$  96  
 $R_9$  79

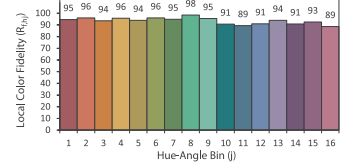
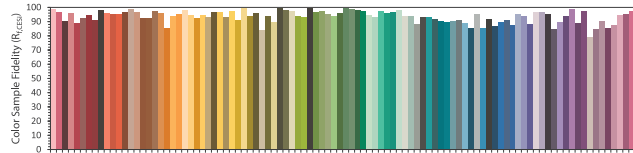

### Clarté Lighting 3000K 90+ CRI Dimmed Halogen Lens (DH) Color Metrics

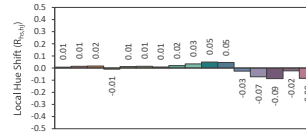
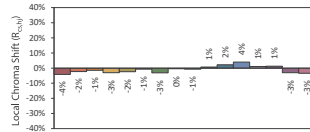
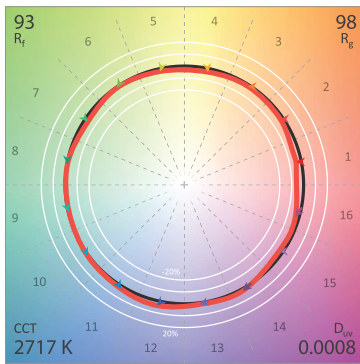

CIE 13.3-1995 (CRI)  
 $R_a$  95  
 $R_9$  64

