

RR5-615-PAR30

Fixed Downlight

Project Name:		Type:	
Catalog Number:		Date:	

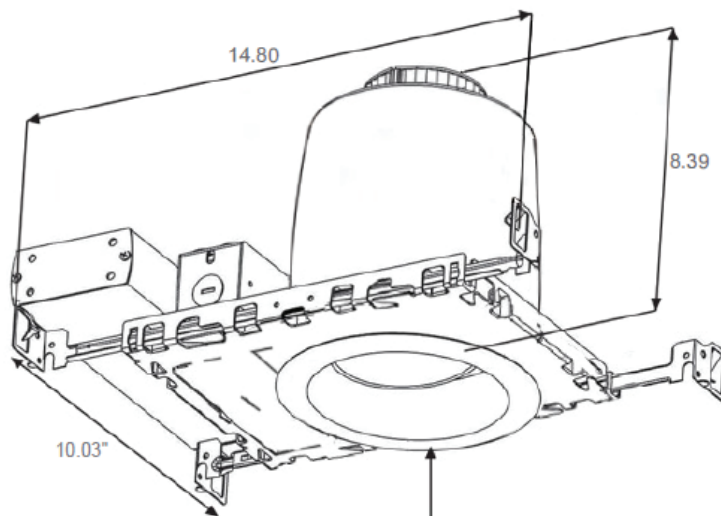
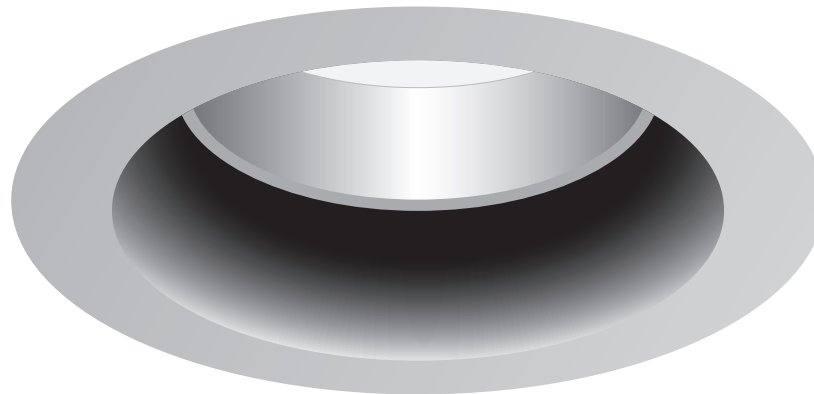

5.5" Inner Diameter
7.1" Outer Diameter

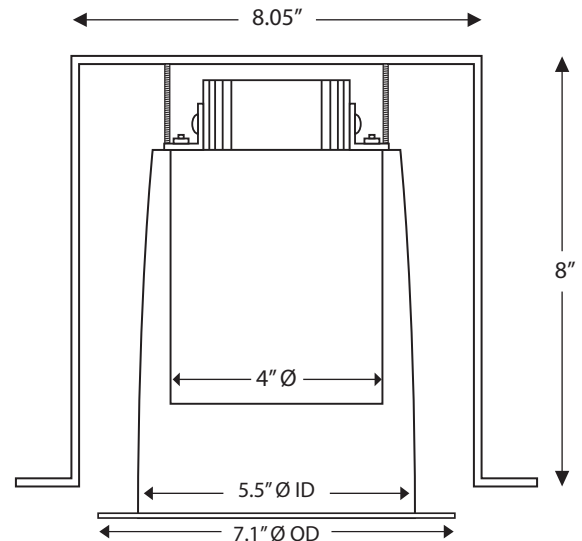

Key Features

- 5.5" ID - 7.1" OD
- Fixed
- IC or NON IC version
- Remote Transformer Optoin
- .02" Uber Thin Trim Lip
- Over 10,000+ fixture custom color finish options
- 100,000+ L70 life

LED Source Details

- CREE XPL2 LED maximum rating = 3,000mA
- Fixture operating milliamp range = 450mA to 1200mA.
- Operating 23% to 53% of rated value
- Fixture wattage range = 8W to 20W
- Fixture delivered lumens = 700 to 1,300 lumens

Last revised: 03/20/2024

Project Name:		Type:	
Catalog Number:		Date:	

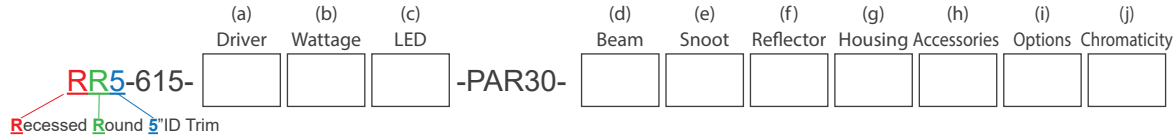

(a) Driver Options

- E = ON/OFF (Electronic)
- D = MLV 1% Dimming (2 wire)
- DC12V = .01% PWM DC dimming (2 wire)
- DC24V = .01% PWM DC dimming (2 wire)
- ED = Electronic Reverse Phase Dimming 1% (2 wire)
- 0-10V1 = 0-10V 1% Dimming (4 wire)
- RDM DMX = 16 Bit, 4 Channel (2 wire with CAT5)

(b) Wattage Options

- 24W (700 milliamps/1600 lumens) = ON/OFF, 0-10V 1%
- 27W (700 milliamps/1600 lumens) = MLV <1% Dimming
- 36W (1050 milliamps/2400 lumens) = ON/OFF, 0-10V 1%
- 42W (1050 milliamps/2400 lumens) = MLV <1% Dimming
- 48W (600 milliamps/2000 lumens) = RDM DMX RGBW
- 48W (1200 milliamps/3000 lumens) = Lutron Dimming
- 51W (1200 milliamps/3000 lumens) = MLV <1% Dimming
- 55W (1400 milliamps /3500 lumens) = ON/OFF, 0-10V 1% or RDM DMX

(c) Lamp Type Options

- XLED = Cree XPL2 LED @ All Wattages

(d) Beam Options

- NSP = Narrow Spot
- SP = Spot
- NFL = Narrow Flood
- FL = Flood

(e) Snoot Color Options

- BLKS = Black Snoot
- WHTS = White Snoot
- PWTS = Pewter Snoot







(f) Reflector/Trim Lip Color Options

- WHT/WHT = White Reflector/White Trim Lip
- BLK/BLK = Black Reflector/Black Trim Lip
- SA/WHT = Specular Reflector/White Trim Lip

(g) Fixture Housing Options

- Non-IC Rated:**
- NC = New Construction
 - RET = Retrofit

(h) Optical and Accessory Options

- LS = Lens Softener - +20% increase in beam width. Shields optical face visually. Softens edges of beam. 
- LSL = Linear Spread Lens - Horizontal or vertical beam elongation. 
- WFL = Wide Flood Lens - Wall washing increases the beam by 50% width with elimination of center beam. 
- LV = Louver - Small black hexcel louver eliminates all surface brightness. Creates stronger vertical cut off with -20% beam width. 
- CHL = Cross Hiar Louver 
- H = Halogen - 150K warmer. 2700k to 2550K 
- DH = Dimmed Halogen - 300K warmer. 2700k to 2400K

(j) Options

- RMT14 = 14Watt 12V AC MLV Step Down Transformer
- RMT60 = 60Watt 12V AC MLV Step Down Transformer
- RMT150 = 150Watt 12V AC MLV Step Down Transformer
- RMT300 = 300Watt 12V AC MLV Step Down Transformer
- 12V = DC
- 24V = DC
- 120V = 120VAC 60Hz (Standard)
- 230V = 230VAC 50Hz
- 277V = 277VAC 60Hz
- 347V = 347VAC 60Hz
- EMG = 90min Emergency Back-Up Battery
- TB = DMX 5-pin Plug-in Terminal Block
- RMT = Remote transformer with remodel trim
- 80+ = CRI over 80
- 90+ = CRI over 90
- DMX* = 39% - 100%, 1200 mA constant voltage driver, dip switch addressable. 3-channel for 27K & 3K, 4-channel for RGBW CAT5 in & out

*DMX is required in RGBW or in any 2-circuits or more.

(k) Color Temperature Options

- | | |
|--|--------------------------------------|
| White LED | Colored/Themed LED |
| 22K* = 2200 Kelvin (candlelight color) | UV275** = 275 NM UV virus sterilizer |
| 27K = 2700 Kelvin (incandescent color) | UV365*** = 365 NM UV black light |
| 30K = 3000 Kelvin (halogen color) | UV390*** = 390 NM UV black light |
| 35K = 3500 Kelvin (warm incandescent) | Blue*** = 465 - 485 NM wavelength |
| 40K = 4000 Kelvin (cool incandescent) | Green*** = 520 - 535 NM wavelength |
| 50K = 5000 Kelvin (day white) | Amber*** = 585 - 595NM wavelength |
| 65K = 6500 Kelvin (12 noon sunlight) | Red*** = 620 - 630 NM wavelength |
| | RGBW3K**** = Red, Green, Blue, White |
| | RGBW4K**** = Red, Green, Blue, White |

*1050 mA or less

**500 mA

***700 mA

****Must utilize DMX @ 700 mA

RR5-615-PAR30

Fixed Downlight

Project Name:		Type:	
Catalog Number:		Date:	

Retrofit/Remodel Version:

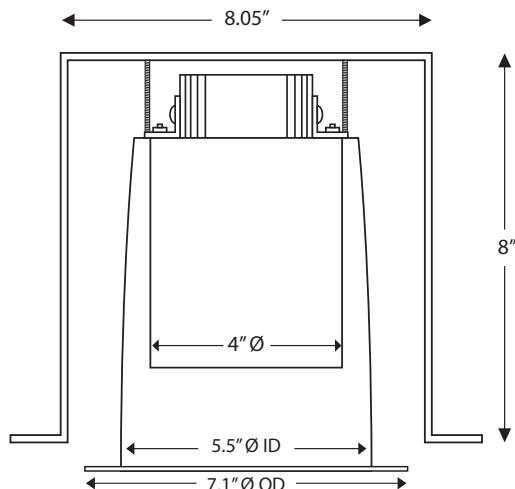
**Housing**

- 100% aluminum construction
- IC housing with hinged 4" x 6" side access panel to j-box & LED driver

Electrical

- IC or NON-IC fixture housing
- Optional - 12V AC remote class 2
- Optional - 12V or 24 DC remote class 2
- 100V, 120V, 230V, 277V or 347V

LED

- 3,000 maximum milliamp rated CREE LED
- Operates between 450 to 1200 milliamps
- L70 life = 100,000 hr.+

LED Driver

- D – 2 wire forward phase .01% LED driver fade to off glow to on
- ED – 2 wire reverse phase 1% LED driver
- DC – 12V or 24V
- 0-10V – 3 wire 1% LED driver
- Absolute Light – Remote mount class 2 48V din rail .001% LED system
- 16-bit RMD DMX – 65,536 dimming steps fade to off glow to on

Optics

- TIR discrete injection molded polycarbonate precision LED optic
- 45-degree vertical cut off

Trim

- .02" thin trim lip
- Hydro form reflector - no spin marks

Trim Finish

- Specular Aluminum Anodized
- Matt Aluminum Anodized
- White, Black or Pewter Powder Coat Paint
- 3300+ Custom Power Coat Paint Colors
- 7000+ Custom Wet Paint Colors

Level Plane Installation

- Available in 1/2" regress trimless, and level plane

Installation

- Accommodates ceiling thickness up to 2.5"
- Universal adjustable 24" adjustable hangar bars

Certification

- UL Damp Listed – IP 52

Warranty

- 5 Year – ED, 0-10V, DMX and colored LED fixtures
- 7 Year – D and White LED fixtures

3 Trim Installation Options

RR5-615-PAR30

Fixed Downlight

Project Name:		Type:	
Catalog Number:		Date:	

Wattage & Lumen Output

700 Milliamps - 1800 Lumens 22W	1000 Milliamps - 2500 Lumens 33W	1200 Milliamps - 3100 Lumens 42W	1400 Milliamps - 3400 Lumens 46W	1600 Milliamps - 3900 Lumens 55W
---	--	--	--	--

3 Step CREE XPL2 LED

Kelvin-CRI	Multiplier
27K-80+ CRI	1
27K-90+ CRI	0.80
30K-80+ CRI	1
30K-90+ CRI	0.85
35K-80+ CRI	1.05
35K-90+ CRI	0.9
40K-80+ CRI	1.09
50K-80+ CRI	1.09
65K-80+ CRI	1.05
80+ = 84 CRI	
90+ = 94 CRI	

Spot 19°

4'	1,370 fc	1.4'
6'	609 fc	2.1'
8'	342 fc	2.8'
10'	219 fc	3.5'
12'	152 fc	4.2'
20'	55 fc	7.0'
26.7'	31 fc	9.4'
40'	14 fc	14.0'

55W PAR30 - 3,607 lm

Narrow Spot 12°

2'	11,097 fc	0.4'
4'	2,774 fc	0.9'
6'	1,233 fc	1.3'
8'	694 fc	1.7'
10'	444 fc	2.1'
12'	308 fc	2.6'

55W PAR30 - 3,372 lm

Narrow Flood 22°

4'	1,192 fc	1.5'
6'	530 fc	2.2'
8'	298 fc	2.9'
10'	191 fc	3.6'
12'	132 fc	4.4'
20'	48 fc	7.3'
26.7'	27 fc	9.7'
40'	12 fc	14.5'

55W PAR30 - 3,481 lm

Flood 32°

4'	403 fc	2.3'
6'	179 fc	3.4'
8'	101 fc	4.5'
10'	65 fc	5.7'
12'	45 fc	6.8'
20'	16 fc	11.3'
26.7'	9 fc	15.1'
40'	4 fc	22.7'

55W PAR30 - 3,245 lm

Intensity Summary (cd)

Gamma	All Planes	Flux (lm)
0	44389	
5	27240	1963
10	9044	
15	2798	872
20	854	
25	440	214
30	285	
35	211	135
40	172	
45	133	105
50	102	
55	57	56
60	45	
65	29	25
70	3	
75	1	1
80	1	
85	0	0
90	0	

Intensity Summary (cd)

Gamma	All Planes	Flux (lm)
0	19074	
5	16233	1332
10	9848	
15	5190	1461
20	2626	
25	1289	620
30	632	
35	329	220
40	211	
45	146	114
50	98	
55	57	55
60	42	
65	27	26
70	14	
75	9	10
80	6	
85	2	3
90	0	

Intensity Summary (cd)

Gamma	All Planes	Flux (lm)
0	6451	
5	5949	529
10	4754	
15	3424	944
20	2326	
25	1552	720
30	1033	
35	639	405
40	368	
45	227	181
50	145	
55	88	83
60	58	
65	39	39
70	21	
75	14	15
80	9	
85	4	4
90	0	

Zonal Flux and Percentages

Zone	Flux (lm)	%Luminaire
0-30	3049	90.4
0-40	3784	94.4
0-60	3345	99.2
0-90	3372	100.0
40-90	188	5.6
60-90	27	0.8
90-180	0	0.0
0-180	3372	100.0

Zonal Flux and Percentages

Zone	Flux (lm)	%Luminaire
0-30	3413	88.8
0-40	3633	94.6
0-60	3802	99.0
0-90	3840	100.0
40-90	208	5.4
60-90	39	1.0
90-180	0	0.0
0-180	3841	100.0

Zonal Flux and Percentages

Zone	Flux (lm)	%Luminaire
0-30	2193	75.1
0-40	2598	89.0
0-60	2862	98.0
0-90	2919	100.0
40-90	321	11.0
60-90	58	2.0
90-180	0	0.0
0-180	2919	100.0

All planes - Solid (cd)

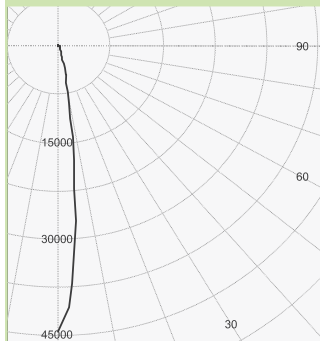

All planes - Solid (cd)

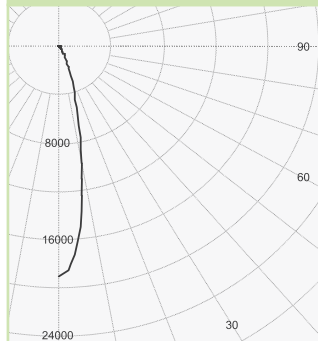

All planes - Solid (cd)

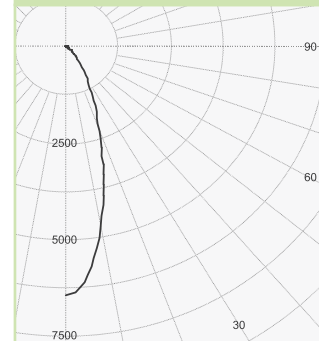

Project Name:		Type:	
Catalog Number:		Date:	

Clarté Lighting 3000K 80+ CRI Color Metrics

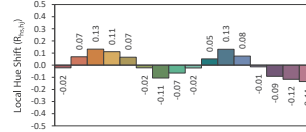
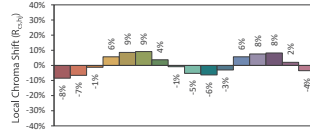
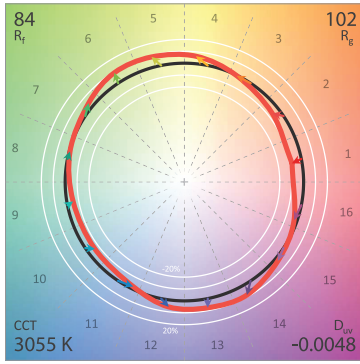

CIE 13.3-1995
 (CRI)
 R_a 86
 R_g 29

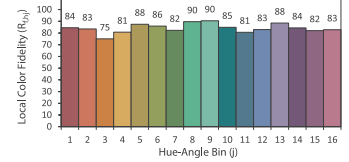
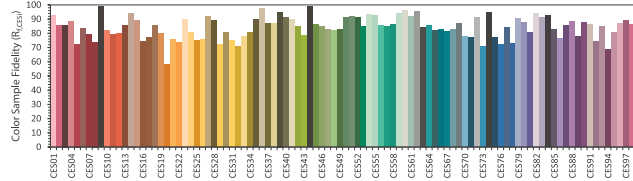

Clarté Lighting 3000K 90+ CRI Color Metrics

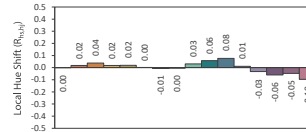
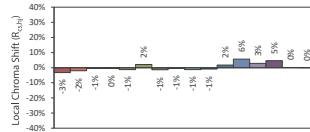
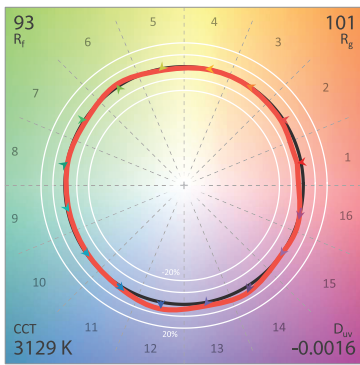

CIE 13.3-1995
 (CRI)
 R_a 95
 R_g 74

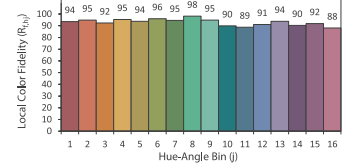
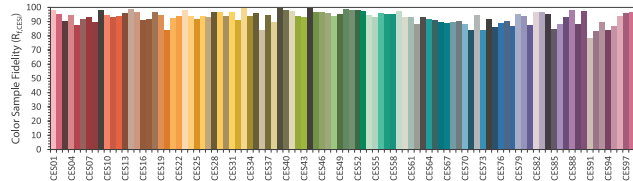

Clarté Lighting 3000K 90+ CRI Halogen Lens (H) Color Metrics

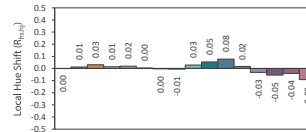
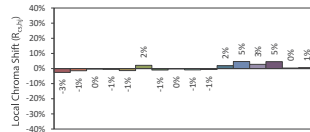
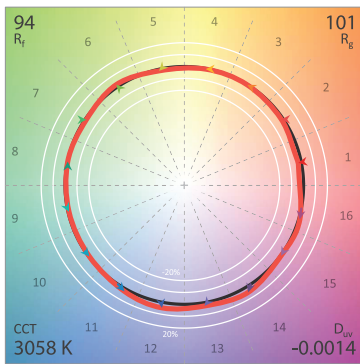

CIE 13.3-1995
 (CRI)
 R_a 96
 R_g 79

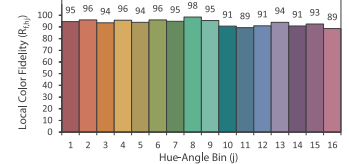
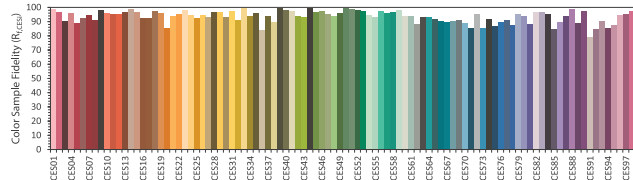

Clarté Lighting 3000K 90+ CRI Dimmed Halogen Lens (DH) Color Metrics

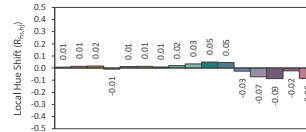
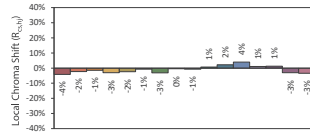
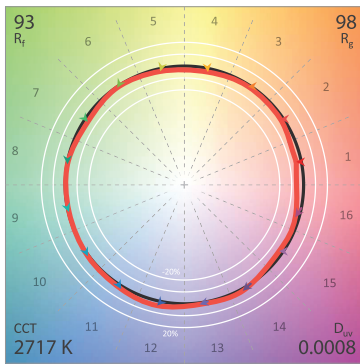

CIE 13.3-1995
 (CRI)
 R_a 95
 R_g 64

