

SS6-642-PAR38

6" Surface Mounted Cuboid

Project Name:		Type:	
Catalog Number:		Date:	

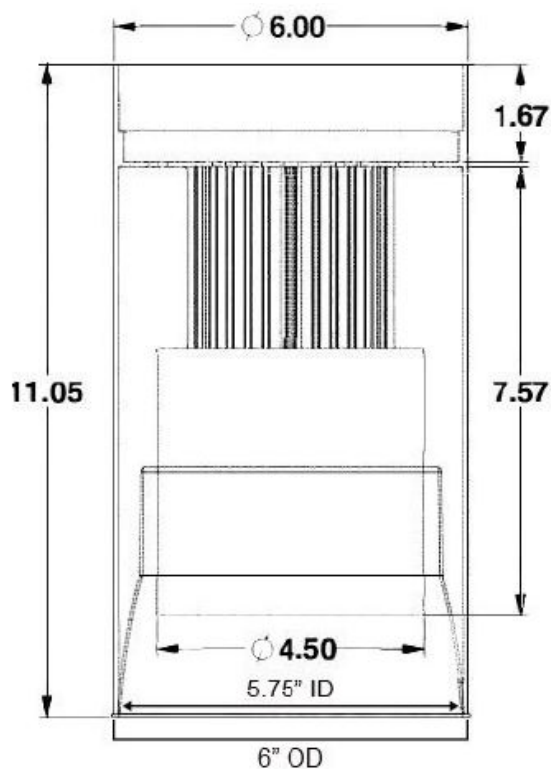
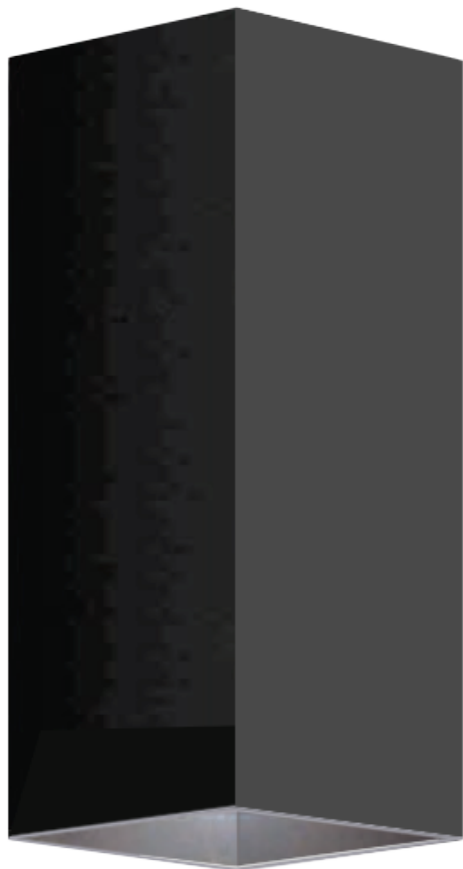

Key Features

- 6" OD
- Up to 4 accessories
- Remote transformer option
- Over 10,000+ fixture custom color finish options
- 100,000+ hr L70 life

LED Source Details

- CREE XPL2 LED maximum rating 3,000 mA
- Fixture operating milliamps = 1,500 mA
 - Fixture Wattage Range = 64W to 68W
 - Fixture Delivered Lumens = 4,500 lumens

Patent Pending

Last revised: 03/20/2024

SS6-642-PAR38

6" Surface Mounted Cuboid

Project Name:		Type:	
Catalog Number:		Date:	

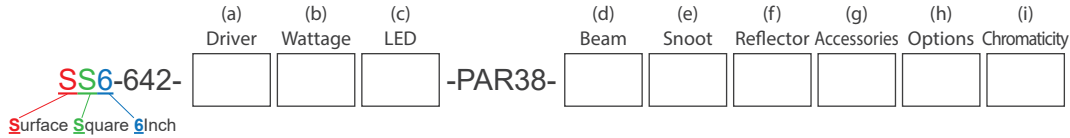

(a) Driver Options

- E = ON/OFF (Electronic)
- D = MLV 1% Dimming (2 wire)
- 0-10V1 = 0-10V 1% Dimming (4 wire)
- RDM DMX = 8 Bit or 16 Bit, 4 Channel (2 wire with CAT5)

(b) Wattage Options

- 64W = 1500 milliamps/4500 lumens, ON/OFF, 0-10V or RDM DMX
- 68W = 1200 milliamps/3600 lumens, MLV
- 72W = 600 milliamps/3000 lumens, RDM DMX RGBW

(c) Lamp Type Options

- XLED = Cree XPL2 LED @ All Wattages

(d) Beam Options

- NSP = Narrow Spot
- SP = Spot
- NFL = Narrow Flood
- FL = Flood







(e) Snoot Color Options

- BLKS = Black Snoot
- WHTS = White Snoot
- PWT = Pewter Snoot
- Select Custom Color (Review Website for Over 3,300 Color Options)

(f) Reflector Color Options

- BLK = Black Reflector
- WHT = White Reflector
- SA = Satin Aluminum Reflector

(g) Optical and Accessory Options

- LS = Lens Softener - +20% increase in beam width. Shields optical face visually. Softens edges of beam. 
- LSL = Linear Spread Lens - Horizontal or vertical beam elongation. 
- WFL = Wide Flood Lens - Wall washing increases the beam by 50% width with elimination of center beam. 
- LV = Louver - Small black hexcel louver eliminates all surface brightness. Creates stronger vertical cut off with -20% beam width. 
- CHL = Cross Hiar Louver 
- H = Halogen - 150K warmer. 2700k to 2550K 
- DH = Dimmed Halogen - 300K warmer. 2700k to 2400K

(h) Options

- EMG = 90min Emergency Back-Up Battery
- 80+ = CRI over 80
- 90+ = CRI over 90

(i) Color Temperature Options

- | | |
|--|--------------------------------------|
| White LED | Colored/Themed LED |
| 22K* = 2200 Kelvin (candlelight color) | UV275** = 275 NM UV virus sterilizer |
| 27K = 2700 Kelvin (incandescent color) | UV365*** = 365 NM UV black light |
| 30K = 3000 Kelvin (halogen color) | UV390*** = 390 NM UV black light |
| 35K = 3500 Kelvin (warm incandescent) | Blue*** = 465 - 485 NM wavelength |
| 40K = 4000 Kelvin (cool incandescent) | Green*** = 520 - 535 NM wavelength |
| 50K = 5000 Kelvin (day white) | Amber*** = 585 - 595NM wavelength |
| 65K = 6500 Kelvin (12 noon sunlight) | Red*** = 620 - 630 NM wavelength |
| | RGBW3K**** = Red, Green, Blue, White |
| | RGBW4K**** = Red, Green, Blue, White |
| *1050 mA or less | **500 mA |
| | ***700 mA |
| | ****Must utilize DMX @ 700 mA |

SS6-642-PAR38

6" Surface Mounted Cuboid

Project Name:		Type:	
Catalog Number:		Date:	

Housing

- 100% aluminum construction

Electrical

- Optional - 12V AC remote class 2
- 100V, 120V, 230V, 277V or 347V

LED

- 3,000mA maximum rated CREE XPL2 LED
- Operates between 450 to 1200mA
- 15% to 40% of rated mA

LED Driver

- D – 2 wire forward phase .01% LED driver fade to off glow to on
- ED – 2 wire reverse phase 1% LED driver
- DC – 12V or 24V

Optics

- TIR discrete injection molded polycarbonate precision LED optic
- 45-degree vertical cut off

Installation

- IPS Nipple - Unistrut (Not provided)

Certification

- UL Damp Listed – IP 52

Warranty

- 5 Year – ED, 0-10V, DMX and colored LED fixtures
- 7 Year – D and White LED fixtures

SS6-642-PAR38

6" Surface Mounted Cuboid

Project Name:		Type:	
Catalog Number:		Date:	

Wattage & Lumen Output

1400 Milliamps - 5000 Lumens	
68W	ON/OFF
	0-10V 1% Dimming
70W	DMX Dimming

3 Step CREE XPL2 LED

Kelvin-CRI	Multiplier
27K-80+ CRI	1
27K-90+ CRI	0.80
30K-80+ CRI	1
30K-90+ CRI	0.85
35K-80+ CRI	105
35K-90+ CRI	0.9
40K-80+ CRI	109
50K-80+ CRI	109
65K-80+ CRI	105
80+ = 84 CRI	
90+ = 94 CRI	

Narrow Flood 21°

2'	5,157 fc	0.7'
4'	1,289 fc	1.5'
6'	573 fc	2.2'
8'	322 fc	3.0'
10'	206 fc	3.7'
12'	143 fc	4.4'



67W PAR38 - 4,266 lm

Zonal Flux and Percentages

Zone	Flux (lm)	%Luminaire
0-30	3369	79.0
0-40	3739	87.7
0-60	4197	98.4
0-90	4266	100.0
40-90	527	12.3
60-90	69	1.6
90-180	0	0.0
0-180	4266	100.0

All planes - Solid (cd)

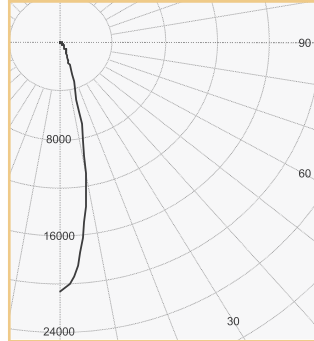

(Rotational Symmetry)

Intensity Summary (cd)

Gamma	All Planes	Flux (lm)
0	20628	
5	17468	1451
10	10916	
15	4848	1396
20	1966	
25	1066	522
30	764	
35	582	370
40	476	
45	381	295
50	291	
55	177	163
60	103	
65	73	65
70	14	
75	3	4
80	1	
85	0	1
90	0	

Project Name:		Type:	
Catalog Number:		Date:	

Clarté Lighting 3000K 80+ CRI Color Metrics



CIE 13.3-1995 (CRI)
 R_a 86
 R₉ 29

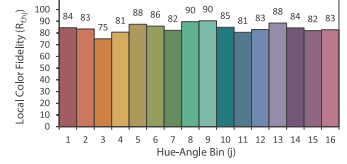

Clarté Lighting 3000K 90+ CRI Color Metrics



CIE 13.3-1995 (CRI)
 R_a 95
 R₉ 74

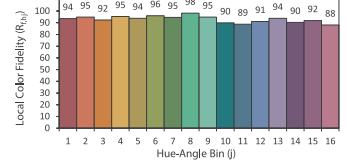

Clarté Lighting 3000K 90+ CRI Halogen Lens (H) Color Metrics



CIE 13.3-1995 (CRI)
 R_a 96
 R₉ 79

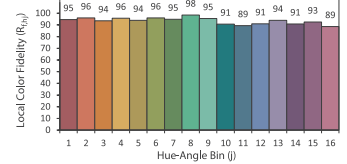

Clarté Lighting 3000K 90+ CRI Dimmed Halogen Lens (DH) Color Metrics



CIE 13.3-1995 (CRI)
 R_a 95
 R₉ 64

