

RS2-293-PAR16

2" Square Shallow 45° Adjustable

Project Name:		Type:	
Catalog Number:		Date:	

Recessed with Trim

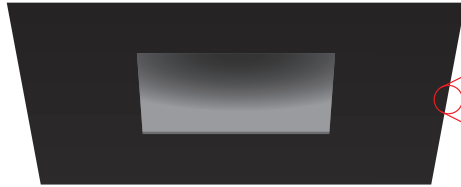

Level Plane

Trim sits flush/level with ceiling

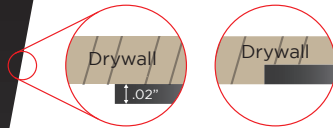

Inset Trimless

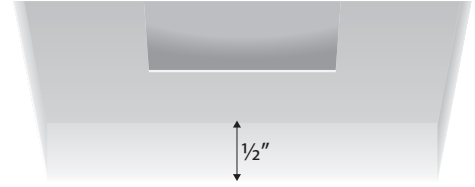

1/2"

4" Perimeter

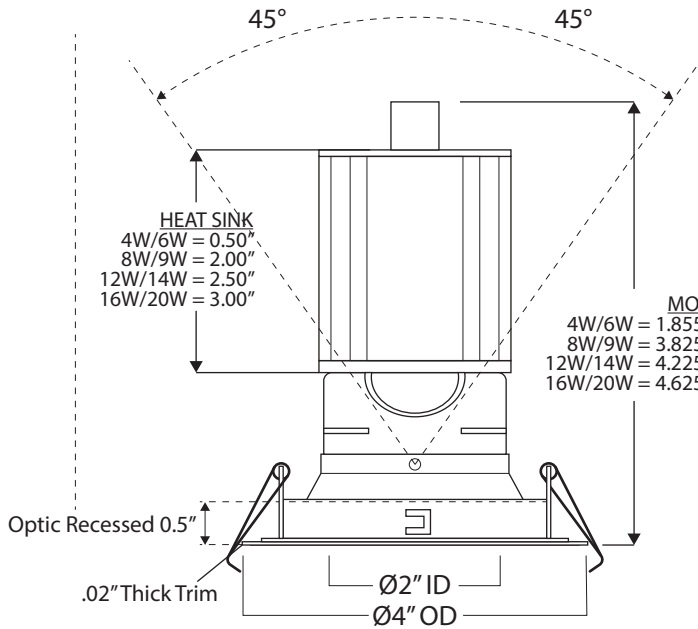

WOS (Wire Out Side) - Reduces MOL 1/2"

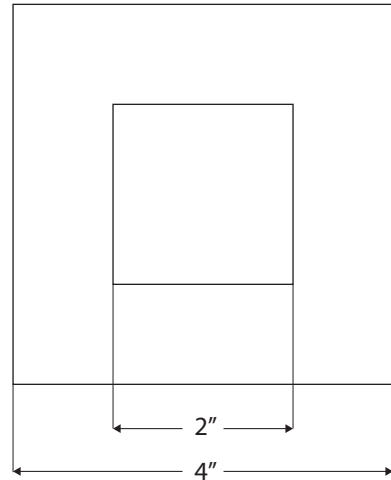

Key Features

- 2" ID - 4" OD
- Adjustable
- 365° Rotation
- IC or NON IC version
- Remote Transformer Optoin
- .02" Uber Thin Trim Lip
- Over 10,000+ fixture custom color finish options
- 100,000+ L70 life

LED Source Details

- CREE XPL LED maximum rating = 3,000mA
- Fixture operating milliamp range = 450mA to 1150mA.
 - Operating 15% to 38% of rated value
 - Fixture wattage range = 8W to 20W
 - Fixture delivered lumens = 700 to 1,300 lumens

Last revised: 04/16/2024

RS2-293-PAR16

2" Square Shallow 45° Adjustable

Project Name:		Type:	
Catalog Number:		Date:	

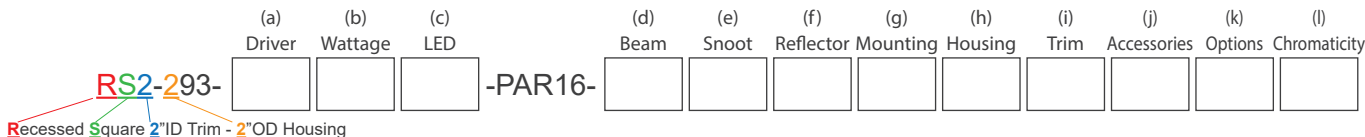

(a) Driver Options

- E = ON/OFF (Electronic)
- D* = MLV 1% Dimming (2 wire)
- DC12V = .01% PWM DC dimming (2 wire)
- DC24V = .01% PWM DC dimming (2 wire)
- ED = Electronic Reverse Phase Dimming 1% (2 wire)
- 0-10V** = Remote mount 4 wire 0-10V LED driver single fixture
- 0-10V 2 = Remote mount 4 wire 0-10V driver for up to 2 fixtures
- 0-10V 3 = Remote mount 4 wire 0-10V driver for up to 3 fixtures
- 0-10V 4*** = Remote mount 4 wire 0-10V driver for up to 4 fixtures
- 0-10V MRI**** = 0-10V Dimming with 100bd Filter
- RDM DMX = 16 Bit, 4 Channel (2 wire with CAT5)
- ABS = Absolute Light .001% Dimming (use with RGBW)
- ABSX = DMX Absolute Light .001% RGBW dimming

*MLV power supply is intended for use with forward phase SCR or Triac dimmers.
 *Do not use with relays or toggle switches, do not use with reverse phase dimmers.
 **Remote single 0-10V LED driver up to 18' away 18ga and 50' away 12ga
 ***Remote 0-10V LED driver operates up to 4 fixtures up to 18' away 18ga and 50' away 12ga
 ****Operates up to 4 recessed LED light fixtures for MRI room installation with remote LED driver

(b) Wattage Options

- 8W (520 Lumens) = ON/OFF, 0-10V 1%
- 9W (520 Lumens) = MLV <1% Dimming
- 12W (800 Lumens) = ON/OFF, 0-10V 1%, ED
- 14W (800 Lumens) = MLV <1% Dimming
- 16W (1100 Lumens) = ON/OFF, 0-10V 1%, ED
- 17W (1100 Lumens) = MLV <1% Dimming
- 18W (900 Lumens) = Absolute Light RGBW
- 19W (1300 Lumens) = DMX Dimming
- 20W (1300 Lumens) = ON/OFF, 0-10V 1%, ED

(c) Lamp Type Options

XLED = Cree XPL2 LED @ All Wattages

(d) Beam Options

- NSP = Narrow Spot
- SP = Spot
- NFL = Narrow Flood
- FL = Flood

(e) Snoot Color Options

- BLKS = Black Snoot
- WHTS = White Snoot
- PWTS = Pewter Snoot

(f) Reflector/Trim Lip Color Options

- WHT/WHT = White Reflector/White Trim Lip
- WHT/BLK = White Reflector/Black Trim Lip
- BLK/BLK = Black Reflector/Black Trim Lip
- BLK/WHT = Black Reflector/White Trim Lip

(g) Mounting Options

- ADJ = Adjustable
- FX = Fixed
- WOS = Wires Out the Side (reduces height by 0.5")







(h) Fixture Housing Options

- Non-IC Rated:**
- RMT = No housing, no frame, remote transformer spring clip loaded trim
 - NIC = Frame and junction box to be used with trim version
 - NH-T1 = No housing with zero plane installation
- IC Rated:**
- AH = 8" x 8" Architectural housing to be used with trimmed or zero plane installation

(i) Trim Type

- T = Recessed with Trim
- T1 = Level Plane
- T2 = Inset Trimless
- MT = Micro Trim (1/2" smaller OD)

(j) Optical and Accessory Options

- LS = Lens Softener - +20% increase in beam width. Shields optical face visually. Softens edges of beam. 
- LSL = Linear Spread Lens - Horizontal or vertical beam elongation. 
- WFL = Wide Flood Lens - Wall washing increases the beam by 50% width with elimination of center beam. 
- LV = Louver - Small black hexcel louver eliminates all surface brightness. Creates stronger vertical cut off with -20% beam width. 
- CHL = Cross Hair Louver 
- H = Halogen - 100K warmer. 2700k to 2500K 
- DH = Dimmed Halogen - 400K warmer. 2700k to 2300K

(k) Options

- RMT14 = 14Watt 12V AC MLV Step Down Transformer
- RMT60 = 60Watt 12V AC MLV Step Down Transformer
- RMT150 = 150Watt 12V AC MLV Step Down Transformer
- RMT300 = 300Watt 12V AC MLV Step Down Transformer
- 12V = DC
- 24V = DC
- 120V = 120VAC 60Hz (Standard)
- 230V = 230VAC 50Hz
- 277V = 277VAC 60Hz
- 347V = 347VAC 60Hz
- EMG = 90min Emergency Back-Up Battery
- TB = DMX 5-pin Plug-in Terminal Block
- RMT = Remote transformer with remodel trim
- 80+ = CRI over 80
- 90+ = CRI over 90

*Eliminate the need to install new 12V AC step down transformer, Clarté LED trim installs like changing a lamp.

(l) Color Temperature Options

- | | |
|--|-------------------------------------|
| White LED | Colored/Themed LED |
| 22K* = 2200 Kelvin (candlelight color) | UV365** = 365 NM UV black light |
| 27K = 2700 Kelvin (incandescent color) | UV390** = 390 NM UV black light |
| 30K = 3000 Kelvin (halogen color) | Blue** = 465 - 485 NM wavelength |
| 35K = 3500 Kelvin (warm incandescent) | Green** = 520 - 535 NM wavelength |
| 40K = 4000 Kelvin (cool incandescent) | Amber** = 585 - 595NM wavelength |
| 50K = 5000 Kelvin (day white) | Red** = 620 - 630 NM wavelength |
| 65K = 6500 Kelvin (12 noon sunlight) | RGBW3K*** = Red, Green, Blue, White |
| | RGBW4K*** = Red, Green, Blue, White |

*1050 mA or less
 **700 mA
 ***Must utilize DMX @ 700 mA

RS2-293-PAR16

2" Square Shallow 45° Adjustable

Project Name:		Type:	
Catalog Number:		Date:	

Non-IC: No Housing Remote Transformer Remodel - Trimmed

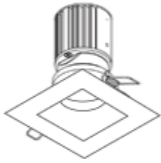

Non-IC: No Housing Framed Fixture with J-Box - Trimmed

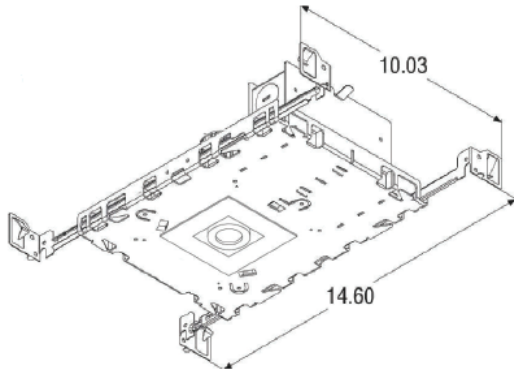

IC: Architectural Housing - Trimless, Level Plane or 1/2" Regressed.

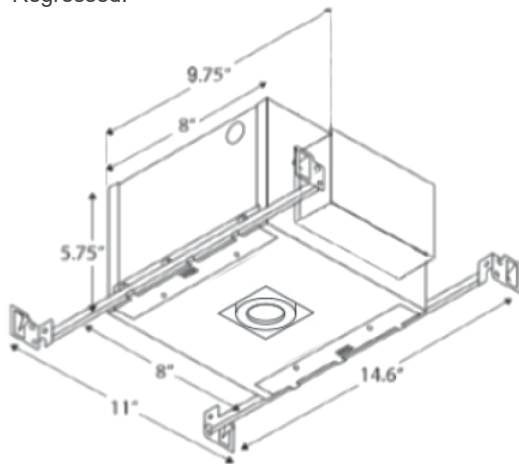
**Housing**

- 100% aluminum construction
- IC housing with hinged 4" x 6" side access panel to j-box & LED driver

Electrical

- IC or NON-IC fixture housing
- Optional - 12V AC remote class 2
- Optional - 12V or 24 DC remote class 2
- 100V, 120V, 230V, 277V or 347V

LED

- 3,000 maximum milliamp rated CREE LED
- Operates between 450 to 1200 milliamps
- L70 life = 100,000 hr.+

LED Driver

- D – 2 wire forward phase .01% LED driver fade to off glow to on
- ED – 2 wire reverse phase 1% LED driver
- DC – 12V or 24V
- 0-10V – 3 wire 1% LED driver
- Absolute Light – Remote mount class 2 48V din rail .001% LED system
- 16-bit RMD DMX – 65,536 dimming steps fade to off glow to on

Optics

- TIR discrete injection molded polycarbonate precision LED optic
- 45-degree vertical cut off

Trim Manufacture

- .02" thin trim lip
- Hydro form reflector - no spin marks

Trim Finish

- Specular Aluminum Anodized
- Matt Aluminum Anodized
- White, Black or Pewter Powder Coat Paint
- 3300+ Custom Power Coat Paint Colors
- 7000+ Custom Wet Paint Colors

Trim Installation Availability

- Recessed with Trim
- Level Plane
- Trimless 1/2" Recessed
- Micro Trim (1/2" smaller OD)

Installation

- Accommodates ceiling thickness up to 2.5"
- Universal adjustable 24" adjustable hangar bars

Certification

- UL Damp Listed – IP 52

Warranty

- 5 Year – ED, 0-10V, DMX and colored LED fixtures
- 7 Year – D and White LED fixtures

RS2-293-PAR16

2" Square Shallow 45° Adjustable

Project Name:		Type:	
Catalog Number:		Date:	

Narrow Narrow Spot 8.5°

3.3'	1,028 fc	0.5'
6.7'	249 fc	1.0'
10'	112 fc	1.5'
13.3'	63.3 fc	2.0'
16.7'	40.1 fc	2.5'
20'	28 fc	3.0'
26.7'	15.7 fc	4.0'
33.3'	10.1 fc	5.0'
40'	7 fc	6.0'

20W PAR16 - 472 lm
11,195 CBCP

Wattage & Lumen Output

450 Milliamps - 520 Lumens		700 Milliamps - 800 Lumens	
8W	ON/OFF	12W	ON/OFF
	0-10V 1% Dimming		0-10V 1% Dimming
9W	MLV <1% Dimming		ELV 10% Dimming
		14W	MLV <1% Dimming
1000 Milliamps - 1100 Lumens		1150 Milliamps - 1300 Lumens	
16W	ON/OFF	20W	ON/OFF
	0-10V 1% Dimming		0-10V 1% Dimming
	ELV 10% Dimming		ELV 10% Dimming
17W	MLV <1% Dimming		
19W	Lutron 1% Dimming		
	DMX .33% Dimming		

3 Step CREE XPL2 LED

Kelvin-CRI	Multiplier
27K-80+ CRI	1
27K-90+ CRI	0.80
30K-80+ CRI	1
30K-90+ CRI	0.85
35K-80+ CRI	105
35K-90+ CRI	0.9
40K-80+ CRI	109
50K-80+ CRI	109
65K-80+ CRI	105
80+ = 84 CRI	
90+ = 94 CRI	

RGBW V2 Light Output Luminous Flux

Clarté Lighting offers 100% of fixtures in optional RGBW3K or RGBW4K

	700 mA RGBW3K	700 mA White 3K
Red	480	
Green	930	
Blue	138	
White	780	
Total	2328	844

*RGBW Fixtures are designed to not operate with all 4 colors at 100% of light for more than 24hrs continuously and suggest operating 55% or less of all 4 colors ON to ensure optimum thermal life of the RGBW LED.

Zonal Flux and Percentages

Zone	Flux (lm)	%Luminaire
0-30	460	97.5
0-40	467	99.0
0-60	472	100.0
0-90	472	100.0
40-70	5	1.0
60-80	0	0.0
90-180	0	0.0
0-180	472	100.0

Narrow Spot 12°

2'	3,824 fc	0.4'
4'	956 fc	0.9'
6'	425 fc	1.3'
8'	239 fc	1.8'
10'	153 fc	2.2'
12'	106 fc	2.7'
20'	28 fc	5.2'
26'	16 fc	7.0'
33'	10 fc	8.7'
40'	7 fc	10.5'

20W PAR16 - 1,100 lm
15,296 CBCP

Spot 19°

2'	1,939 fc	0.7'
4'	485 fc	1.4'
6'	215 fc	2.0'
8'	121 fc	2.7'
10'	78 fc	3.4'
12'	54 fc	4.1'
20'	28 fc	6.1'
26'	16 fc	8.1'
33'	10 fc	10.1'
40'	7 fc	12.1'

20W PAR16 - 1,313 lm
7,757 CBCP

Narrow Flood 24°

2'	1,705 fc	0.7'
4'	426 fc	1.4'
6'	189 fc	2.1'
8'	107 fc	2.8'
10'	68 fc	3.5'
12'	47 fc	4.3'
20'	17 fc	7.5'
26'	10 fc	10.0'
33'	6 fc	12.4'
40'	5 fc	14.9'

20W PAR16 - 1,306 lm
5,478 CBCP

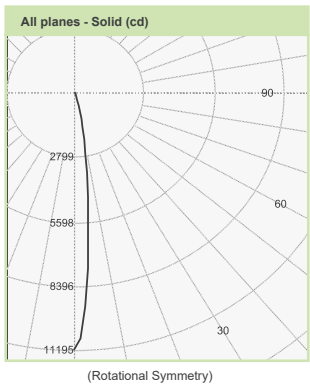

Intensity Summary (cd)

Gamma	All Planes	Flux (lm)
0	15296	
5	9739	696
10	2978	
15	676	236
20	229	
25	135	64
30	90	
35	67	43
40	53	
45	46	35
50	34	
55	23	21
60	15	
65	2	4
70	1	
75	0	0
80	0	
85	0	0
90	0	

Intensity Summary (cd)

Gamma	All Planes	Flux (lm)
0	7757	
5	6432	519
10	3640	
15	1648	475
20	731	
25	336	166
30	176	
35	110	71
40	77	
45	67	50
50	47	
55	29	26
60	15	
65	3	5
70	1	
75	0	1
80	0	
85	0	0
90	0	

Intensity Summary (cd)

Gamma	All Planes	Flux (lm)
0	5478	
5	4774	404
10	3229	
15	1800	500
20	905	
25	452	219
30	244	
35	146	95
40	98	
45	75	57
50	47	
55	25	25
60	15	
65	3	5
70	1	
75	1	1
80	0	
85	0	0
90	0	

Narrow Narrow Spot 7.9° (with Louver)

3.3'	953 fc	0.5'
6.7'	231 fc	0.9'
10'	104 fc	1.4'
13.3'	58.7 fc	1.8'
16.7'	37.2 fc	2.3'
20'	25.9 fc	2.8'
26.7'	14.6 fc	3.7'
33.3'	9.36 fc	4.6'
40'	6.48 fc	5.5'

20W PAR16 - 382 lm
10,376 CBCP

Zonal Flux and Percentages

Zone	Flux (lm)	%Luminaire
0-30	997	90.6
0-40	1040	94.6
0-60	1096	99.6
0-90	1100	100.0
40-90	60	5.4
60-90	4	0.4
90-180	0	0.0
0-180	1100	100.0

Zonal Flux and Percentages

Zone	Flux (lm)	%Luminaire
0-30	1160	88.3
0-40	1231	93.8
0-60	1308	99.6
0-90	1313	100.0
40-90	82	6.2
60-90	5	0.4
90-180	0	0.0
0-180	1313	100.0

Zonal Flux and Percentages

Zone	Flux (lm)	%Luminaire
0-30	1123	86.0
0-40	1219	93.3
0-60	1301	99.6
0-90	1306	100.0
40-90	88	6.7
60-90	6	0.4
90-180	0	0.0
0-180	1306	100.0

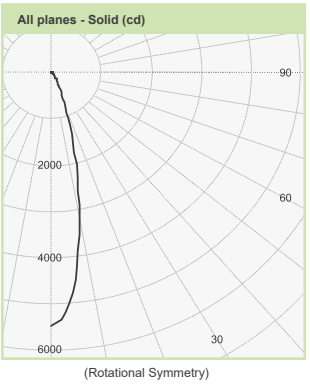
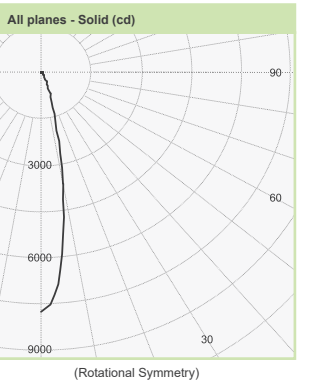
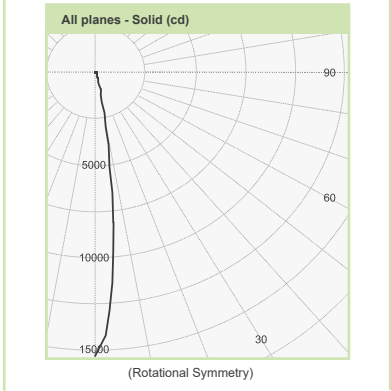
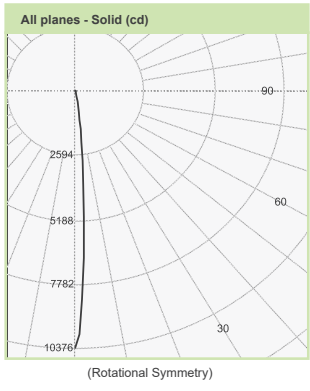

Project Name:		Type:	
Catalog Number:		Date:	

Clarté Lighting 3000K 80+ CRI Color Metrics

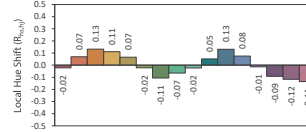
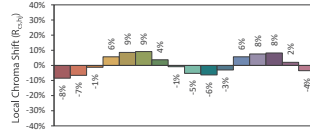
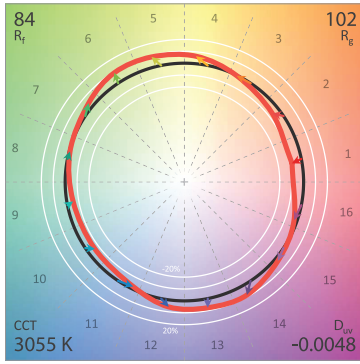

CIE 13.3-1995 (CRI)
 R_a 86
 R_9 29

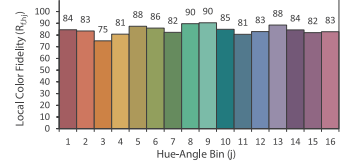
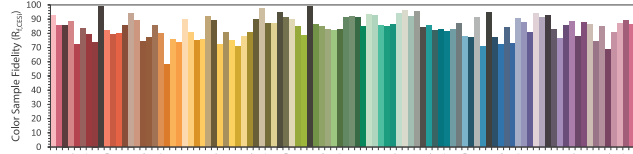

Clarté Lighting 3000K 90+ CRI Color Metrics

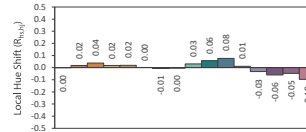
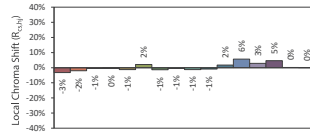
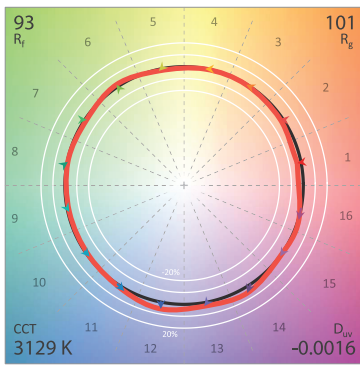

CIE 13.3-1995 (CRI)
 R_a 95
 R_9 74

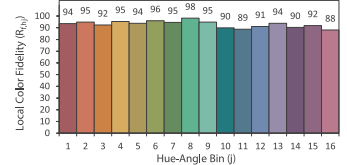
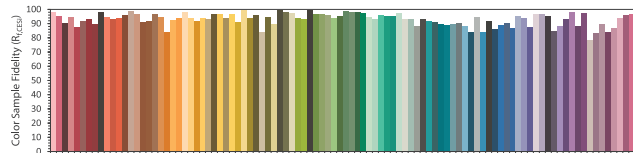

Clarté Lighting 3000K 90+ CRI Halogen Lens (H) Color Metrics

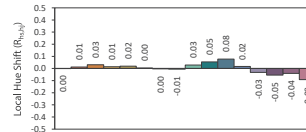
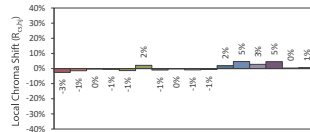
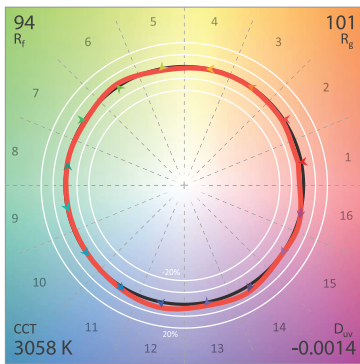

CIE 13.3-1995 (CRI)
 R_a 96
 R_9 79

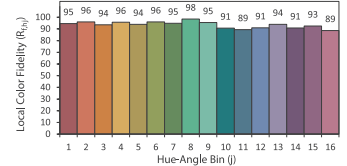
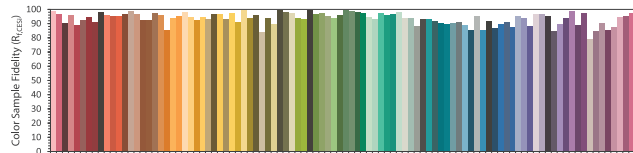

Clarté Lighting 3000K 90+ CRI Dimmed Halogen Lens (DH) Color Metrics

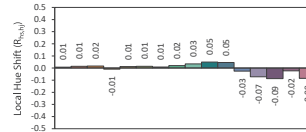
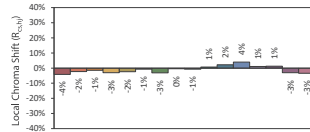
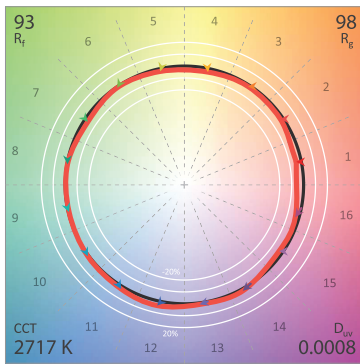

CIE 13.3-1995 (CRI)
 R_a 95
 R_9 64

