

Project Name:		Type:	
Catalog Number:		Date:	

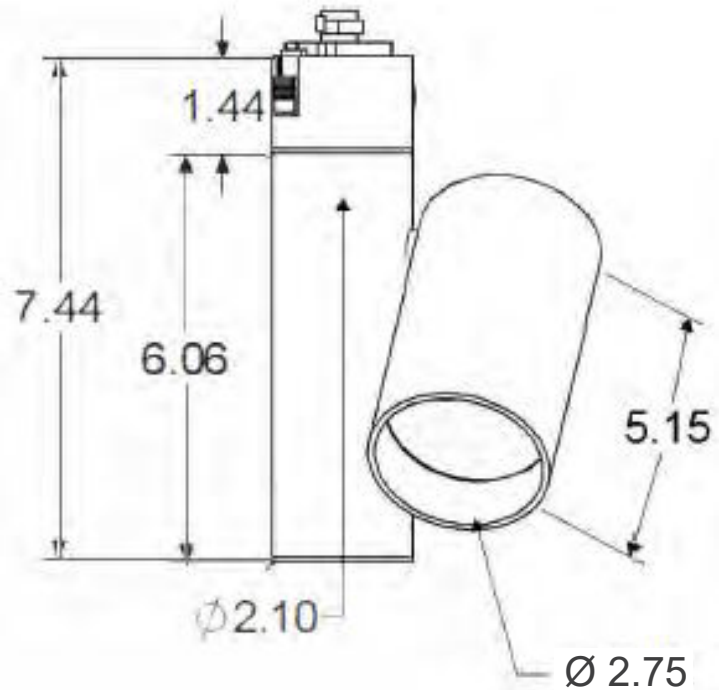

Key Features

- 2.75" OD
- Up to 4 accessories
- Toolless locking LED optic
- 400° Rotation at top
- 358° Rotation on CML stem
- 45° Rotation on CML knuckle
- Remote transformer optoin
- Over 10,000+ fixture custom color finish options
- 100,000+ hr L70 life
- **See Page 3 for additional mounting options**

LED Source Details

- CREE XPL LED maximum rating = 3,000mA
- Fixture operating milliamp range = 450mA to 1200mA.
 - Operating 15% to 40% of rated value
 - Fixture wattage range = 8W to 20W
 - Fixture delivered lumens = 700 to 1,300 lumens

Last revised: 04/10/2024

Project Name:		Type:	
Catalog Number:		Date:	

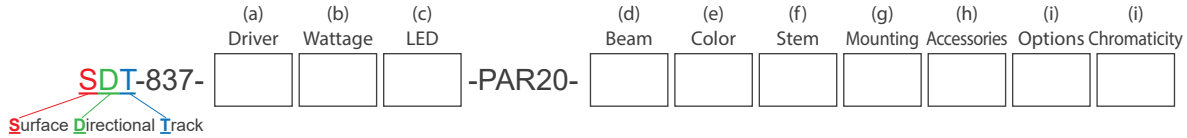

(a) Driver Options

- E = ON/OFF (Electronic)
- D = MLV .01% Dimming (2 wire)
- ED = Electronic Reverse Phase Dimming 1% (2 wire)
- 0-10V1 = 0-10V 1% Dimming (3 wire)
- RDM DMX = 16 Bit, 4 Channel (2 wire with CAT5)

(b) Wattage Options

- 16W (1200 Lumens) = ON/OFF
- 18W (1200 Lumens) = MLV <1% Dimming
- 24W (1800 Lumens) = ON/OFF
- 28W (2000 Lumens) = MLV <1% Dimming, ON/OFF, 0-10V 1%, Lutron, DMX

(c) LED Type Options

- XLED = Cree XPL2 LED @ All Wattages

(d) Beam Options

- NSP = Narrow Spot
- SP = Spot
- NFL = Narrow Flood
- FL = Flood

(e) Fixture Color Options

- BLK = Black
- WHT = White
- PWT = Pewter
- Select Custom Color (Review Website for Over 3,300 Color Options)

(f) Stem Options







- S6 = Stem Size 6"
- S12 = Stem Size 12"
- S18 = Stem Size 18"
- CS* = Custom Stem

*Custom up to 24"

(g) Mounting Options

- CLP = C-Clamp
- CLPP = C-Clamp + Plug
- FCP = Flat Canopy Plate
- CLPD = C-Clamp + Plug MLV
- 2PC = 2" Pipe Clamp
- FCPS = Flat Canopy Plate with Stem

(h) Optical and Accessory Options

- LS = Lens Softener - +20% increase in beam width. Shields optical face visually. Softens edges of beam. 
- LSL = Linear Spread Lens - Horizontal or vertical beam elongation. 
- WFL = Wide Flood Lens - Wall washing increases the beam by 50% width with elimination of center beam. 
- LV = Louver - Small black hexcel louver eliminates all surface brightness. Creates stronger vertical cut off with -20% beam width. 
- CHL = Cross Hair Louver 
- H = Halogen - 100K warmer. 2700k to 2500K 
- DH = Dimmed Halogen - 400K warmer. 2700k to 2300K 

(i) Options

- BTS = Black Tapered Snoot
- WTS = White Tapered Snoot
- WBTS = White Exterior / Black Interior
- WWSN = Wall Wash Snoot
- 80+ = CRI over 80
- 90+ = CRI over 90
- 120V = 120VAC 60Hz (Standard)
- 230V = 230VAC 50Hz (Used in conjunction with 230V track)
- 277V = 277VAC 60Hz (Used in conjunction with 277V track)
- 347V = 347VAC 60Hz
- HLO = Halo (Standard)
- JNO = Juno Compatible (Special Order)
- LTO = Lightolier Compatible (Special Order)
- EP = Edison Price Buss Adapter (Special Order)
- LSI = Lighting Services Track
- FCP = Flat Canopy Plate
- CP = Canopy Plate
- 2PC = 2" Pipe Clamp
- C = C-Clamp
- PL = Coil Grounded Plug
- DMX* = .39% to 100% 1200 milliamp constant voltage LED driver, dip switch addressable, 3 channel for 27K & 30K, 4 channel for RGBW, CAT5 in & out*

*DMX is required in RGBW or in any 2 circuits or more.
Custom colors available - Consult factory for more details

(j) Color Temperature Options

- | White LED | Colored/Themed LED |
|--|--------------------------------------|
| 22K* = 2200 Kelvin (candlelight color) | UV275** = 275 NM UV virus sterilizer |
| 27K = 2700 Kelvin (incandescent color) | UV365*** = 365 NM UV black light |
| 30K = 3000 Kelvin (halogen color) | UV390**** = 390 NM UV black light |
| 35K = 3500 Kelvin (warm incandescent) | Blue*** = 465 - 485 NM wavelength |
| 40K = 4000 Kelvin (cool incandescent) | Green*** = 520 - 535 NM wavelength |
| 50K = 5000 Kelvin (day white) | Amber*** = 585 - 595NM wavelength |
| 60K = 6500 Kelvin (12 noon sunlight) | Red*** = 620 - 630 NM wavelength |
| | RGBW3K**** = Red, Green, Blue, White |
| | RGBW4K**** = Red, Green, Blue, White |

*1050 mA or less

**500 mA

***700 mA

****Must utilize DMX @ 700 mA

SDT-837-PAR20

Vertical Round Track Fixture

Project Name:		Type:	
Catalog Number:		Date:	

Stem Option
(with standard MLV 0-10 driver)

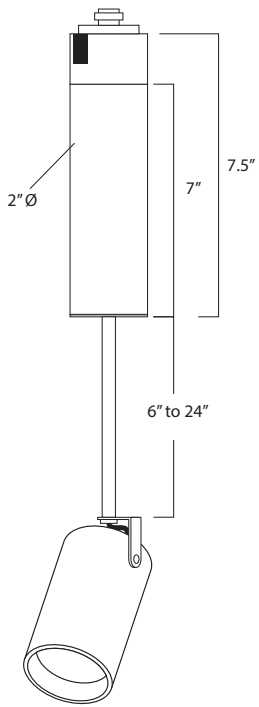

Stem with C-Clamp
(with standard MLV 0-10 driver)

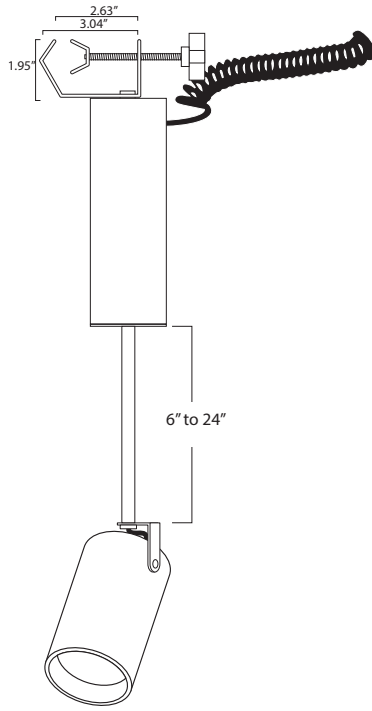

Housing

- 100% aluminum construction

Electrical

- Optional - 12V AC remote class 2
- 100V, 120V, 230V, 277V or 347V

LED

- 3,000mA maximum rated CREE XPL2 LED
- Operates between 450 to 1200mA
- 15% to 40% of rated mA

LED Driver

- D – 2 wire forward phase .01% LED driver fade to off glow to on
- ED – 2 wire reverse phase 1% LED driver
- DC – 12V or 24V
- 0-10V – 3 wire 1% LED driver
- 16-bit RMD DMX – 65,536 dimming steps fade to off glow to on

Optics

- TIR discrete injection molded polycarbonate precision LED optic
- 45-degree vertical cut off

Installation

Track Adapter

- Standard Halo compatible.
- Special Order Track Adapter - Juno, Lightlior, LSI or Esion Price Adapters.

Certification

- UL Damp Listed – IP 52

Warranty

- 5 Year – ED, 0-10V, DMX and colored LED fixtures
- 7 Year – D and White LED fixtures

C-Clamp + Plug MLV
(with DMX driver)

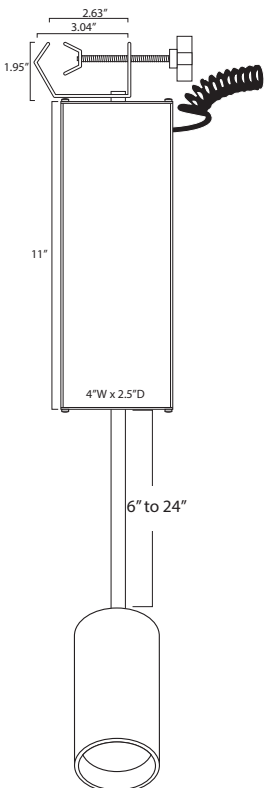

2" Pipe Clamp

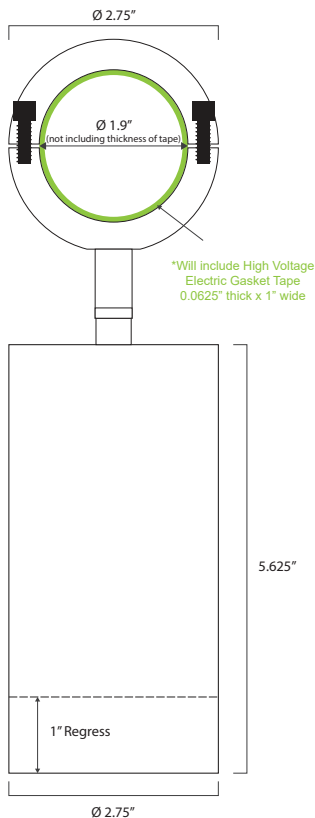

Flat Canopy Plate

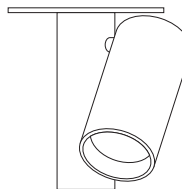

Canopy Plate with Stem

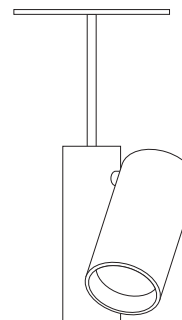

C-Clamp + Plug

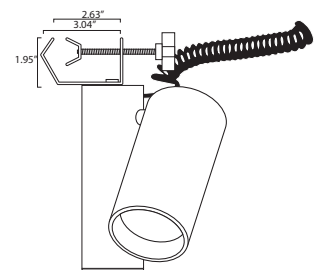

Tapered Snoot (TSN) - Reduce surface brightness and diameter of the beam field with a 1.44" opening, a -36% reduction in the optic face.

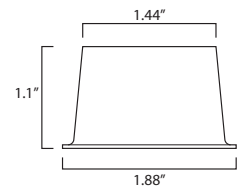

SDT-837-PAR20

Vertical Round Track Fixture

Project Name:		Type:	
Catalog Number:		Date:	

Wattage & Lumen Output

<p>700/750 Milliamps - 1200 Lumens 16W ON/OFF 18W MLV <1% Dimming</p>	<p>1000/1050 Milliamps - 1800 Lumens 24W ON/OFF 28W MLV <1% Dimming</p>	<p>1200 Milliamps - 2000 Lumens 28W MLV <1% Dimming ON/OFF 0-10V 1% Lutron DMX</p>	
---	---	---	--

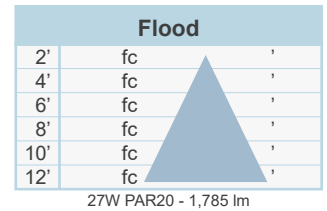
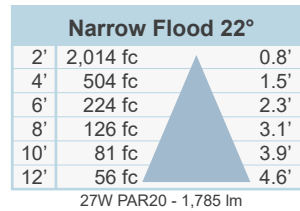
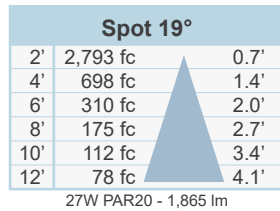
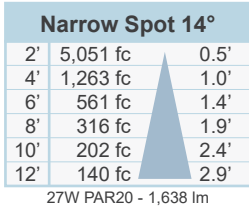

Intensity Summary (cd)

Gamma	All Planes	Flux (lm)
0	20206	
5	13883	1000
10	4389	
15	921	334
20	336	
25	210	99
30	149	
35	117	75
40	102	
45	81	65
50	73	
55	49	47
60	41	
65	15	17
70	1	
75	0	0
80	0	
85	0	
90	0	

Intensity Summary (cd)

Gamma	All Planes	Flux (lm)
0	11174	
5	9332	519
10	5281	
15	2307	475
20	977	
25	422	166
30	220	
35	144	71
40	112	
45	92	50
50	72	
55	48	26
60	41	
65	14	5
70	2	
75	1	1
80	0	
85	0	0
90	0	

Intensity Summary (cd)

Gamma	All Planes	Flux (lm)
0	8057	
5	6932	579
10	4463	
15	2316	650
20	1093	
25	535	261
30	300	
35	194	126
40	146	
45	118	91
50	88	
55	58	56
60	50	
65	14	20
70	3	
75	1	1
80	1	
85	0	0
90	0	

Intensity Summary (cd)

Gamma	All Planes	Flux (lm)
0	3157	
5	3048	281
10	2720	
15	2189	597
20	1558	
25	989	454
30	564	
35	320	207
40	181	
45	105	85
50	67	
55	49	45
60	39	
65	28	28
70	20	
75	17	18
80	13	
85	6	7
90	0	

Zonal Flux and Percentages

Zone	Flux (lm)	%Luminaire
0-30	1433	87.5
0-40	1508	92.1
0-60	1620	98.9
0-90	1638	100.0
40-90	130	7.9
60-90	18	1.1
90-180	0	0.0
0-180	1638	100.0

Zonal Flux and Percentages

Zone	Flux (lm)	%Luminaire
0-30	1635	90.6
0-40	1729	94.6
0-60	1846	99.6
0-90	1865	100.0
40-90	136	5.4
60-90	19	0.4
90-180	0	0.0
0-180	1865	100.0

Zonal Flux and Percentages

Zone	Flux (lm)	%Luminaire
0-30	1490	83.5
0-40	1616	90.5
0-60	1763	98.8
0-90	1785	100.0
40-90	169	9.5
60-90	22	1.2
90-180	0	0.0
0-180	1785	100.0

Zonal Flux and Percentages

Zone	Flux (lm)	%Luminaire
0-30	1332	77.4
0-40	1539	89.4
0-60	1668	96.9
0-90	1721	100.0
40-90	182	10.6
60-90	53	3.1
90-180	0	0.0
0-180	1721	100.0

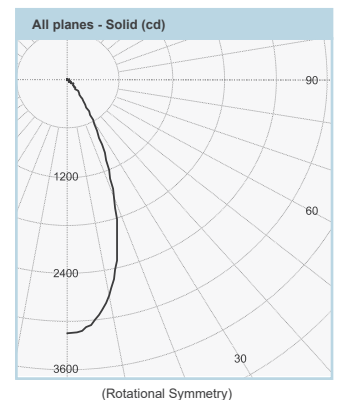
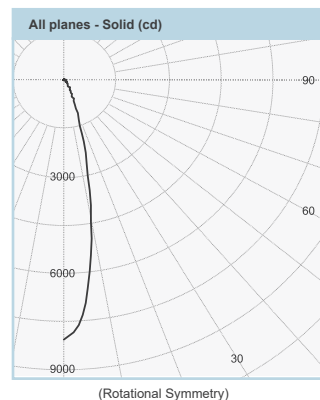
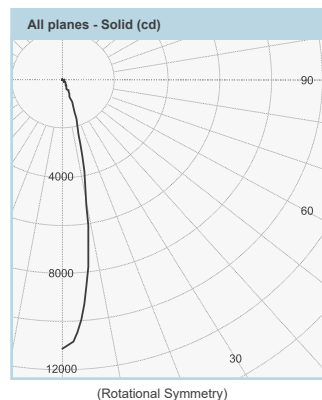
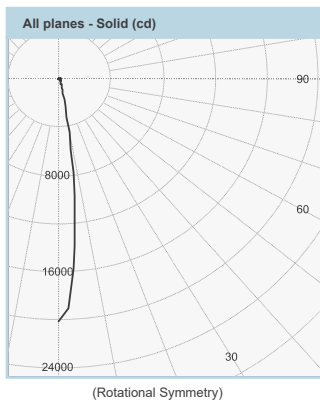

Project Name:		Type:	
Catalog Number:		Date:	

Clarté Lighting 3000K 80+ CRI Color Metrics

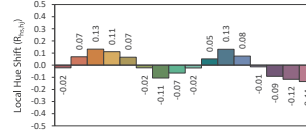
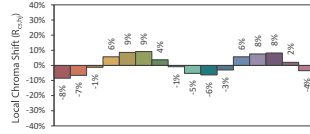

CIE 13.3-1995 (CRI)
 R_a 86
 R_g 29

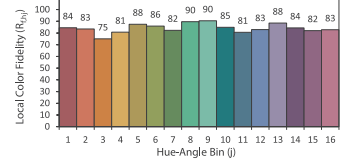

Clarté Lighting 3000K 90+ CRI Color Metrics



CIE 13.3-1995 (CRI)
 R_a 95
 R_g 74

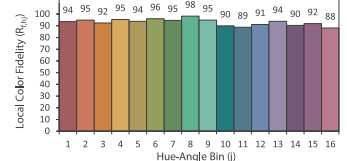
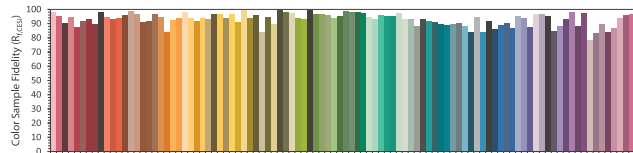

Clarté Lighting 3000K 90+ CRI Halogen Lens (H) Color Metrics



CIE 13.3-1995 (CRI)
 R_a 96
 R_g 79

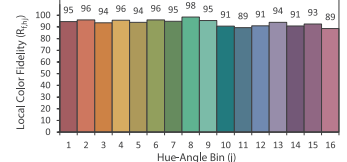
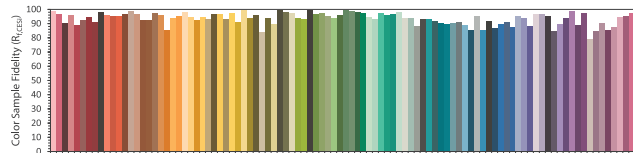

Clarté Lighting 3000K 90+ CRI Dimmed Halogen Lens (DH) Color Metrics



CIE 13.3-1995 (CRI)
 R_a 95
 R_g 64

