

# SMR1-202-PAR20-CM

3" Adjustable Center Mount

Project Name:		Type:	
Catalog Number:		Date:	

## CML Option (Center Mount Locking)

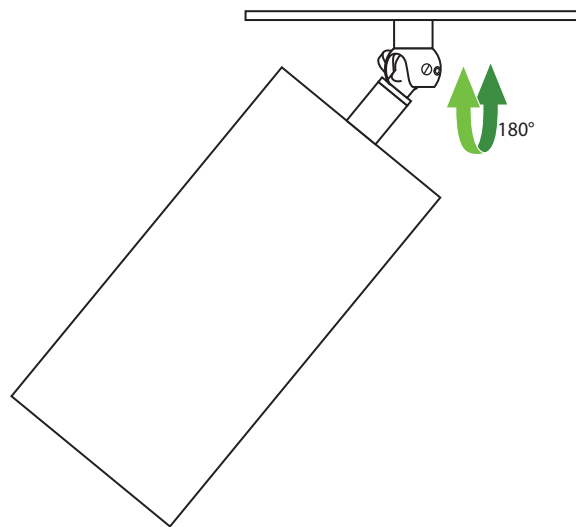
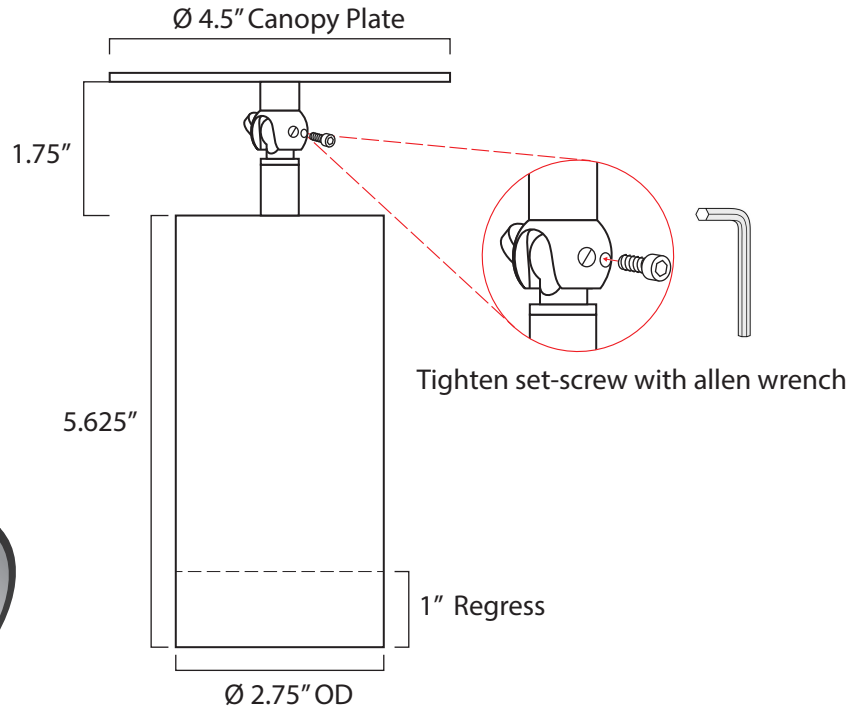

### Key Features

- 2.75" OD
- Up to 4 accessories
- Remote transformer option
- Over 10,000+ fixture custom color finish options
- 100,000+ hr L70 life

### LED Source Details

- CREE XPL2 LED maximum rating = 3,000mA
- Fixture operating milliamp range = 700mA to 1200mA.
  - Operating 23% to 40% of rated value
  - Fixture wattage range = 16W to 28W
  - Fixture delivered lumens = 1,200 to 2,000 lumens

Patent Pending

Last revised: 04/15/2024

Project Name:		Type:	
Catalog Number:		Date:	

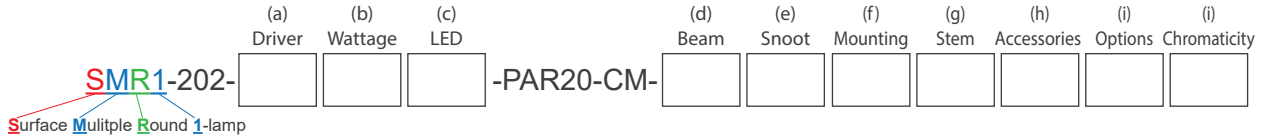

**(a) Driver Options**

- E = ON/OFF (Electronic)
- D\* = MLV 1% Dimming (2 wire)
- DC12V = .01% PWM DC dimming (2 wire)
- DC24V = .01% PWM DC dimming (2 wire)
- ED = Electronic Reverse Phase Dimming 1% (2 wire)
- DALI2 = .01% Digital Addressable Lighting Interface V2
- 0-10V\*\* = Remote mount 4 wire 0-10V LED driver single fixture
- 0-10V 2 = Remote mount 4 wire 0-10V driver for up to 2 fixtures
- RDM DMX = 16 Bit, 4 Channel (2 wire with CAT5)
- ABS = Absolute Light .001% Dimming (use with RGBW)
- ABSX = DMX Absolute Light .001% RGBW dimming

\*MLV power supply is intended for use with forward phase SCR or Triac dimmers.  
 \*Do not use with relays or toggle switches, do not use with reverse phase dimmers.  
 \*\*Remote single 0-10V LED driver up to 18' away 18ga and 50' away 12ga

**(b) Wattage Options**

- 16W (1200 Lumens) = ON/OFF
- 18W (1200 Lumens) = MLV <1% Dimming
- 24W (1800 Lumens) = ON/OFF
- 28W (2000 Lumens) = MLV <1% Dimming, ON/OFF, 0-10V 1%, Lutron, DMX

**(c) Lamp Type Options**

- XLED = Cree XPL2 LED @ All Wattages

**(d) Beam Options**

- NSP = Narrow Spot
- SP = Spot
- NFL = Narrow Flood
- FL = Flood

**(e) Fixture Color Options**

- WHT = White Fixture
- BLK = Black Fixture
- PWT = Pewter Fixture
- PWTB = Pewter Fixture with Piano Black Interior Snoot

**(f) Mounting Options**

- NC = New Construction
- 2PC = 2" Pipe Clamp
- RMT\* = Remote Transformer and Remodel Surface Flat Canopy Mount







\*RDM DMX driver maximum mounting distance 6'

**(g) Stem Options**

- S6 = Stem Size 6"
- S12 = Stem Size 12"
- S18 = Stem Size 18"
- CS\* = Custom Stem

\*Custom stem up to 96" for flat canopy

**(h) Optical and Accessory Options**

- LS = Lens Softener - +20% increase in beam width. Shields optical face visually. Softens edges of beam. 
- LSL = Linear Spread Lens - Horizontal or vertical beam elongation. 
- WFL = Wide Flood Lens - Wall washing increases the beam by 50% width with elimination of center beam. 
- LV = Louver - Small black hexcel louver eliminates all surface brightness. Creates stronger vertical cut off with -20% beam width. 
- CHL = Cross Hiar Louver 
- H = Halogen - 150K warmer. 2700k to 2550K 
- DH = Dimmed Halogen - 300K warmer. 2700k to 2400K 

**(i) Options**

- RMT14 = 14Watt 12V AC MLV Step Down Transformer
- RMT60 = 60Watt 12V AC MLV Step Down Transformer
- RMT150 = 150Watt 12V AC MLV Step Down Transformer
- RMT300 = 300Watt 12V AC MLV Step Down Transformer
- 12V = DC
- 24V = DC
- 120V = 120VAC 60Hz (Standard)
- 230V = 230VAC 50Hz
- 277V = 277VAC 60Hz
- 347V = 347VAC 60Hz
- EMG = 90min Emergency Back-Up Battery
- TB = DMX 5-pin Plug-in Terminal Block
- CML = Center Mount Locking
- SS = Set Screw (#2 Phillips Flat Head Screw with 4.75" Canopy Plate)
- TL = Trimless
- BCPS = Blind Canopy Plate Trimless Stem
- 80+ = CRI over 80
- 90+ = CRI over 90

\*Eliminate the need to install new 12V AC step down transformer, Clarté LED trim installs like changing a lamp.

**(j) Color Temperature Options**

- |  |                                      |
|--|--------------------------------------|
| <b>White LED</b>                       | <b>Colored/Themed LED</b>            |
| 22K* = 2200 Kelvin (candlelight color) | UV275** = 275 NM UV virus sterilizer |
| 27K = 2700 Kelvin (incandescent color) | UV365*** = 365 NM UV black light     |
| 30K = 3000 Kelvin (halogen color)      | UV390*** = 390 NM UV black light     |
| 35K = 3500 Kelvin (warm incandescent)  | Blue*** = 465 - 485 NM wavelength    |
| 40K = 4000 Kelvin (cool incandescent)  | Green*** = 520 - 535 NM wavelength   |
| 50K = 5000 Kelvin (day white)          | Amber*** = 585 - 595NM wavelength    |
| 65K = 6500 Kelvin (12 noon sunlight)   | Red*** = 620 - 630 NM wavelength     |
|  | RGBW3K**** = Red, Green, Blue, White |
|  | RGBW4K**** = Red, Green, Blue, White |

\*1050 mA or less

\*\*500 mA

\*\*\*700 mA

\*\*\*\*Must utilize DMX @ 700 mA

# SMR1-202-PAR20-CM

3" Adjustable Center Mount

Project Name:		Type:	
Catalog Number:		Date:	

## Trimless - 2-Part Design

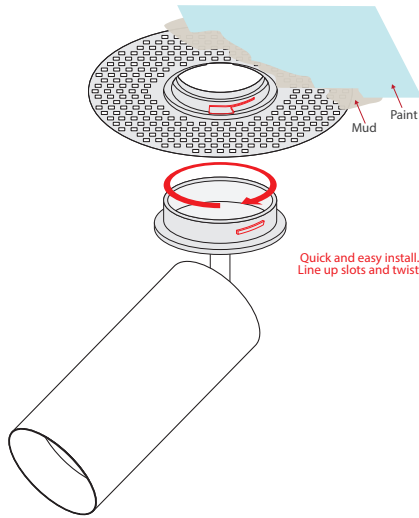

## Blind Canopy Trimless Stem (must utilize remote ELV or 0-10V power supply)

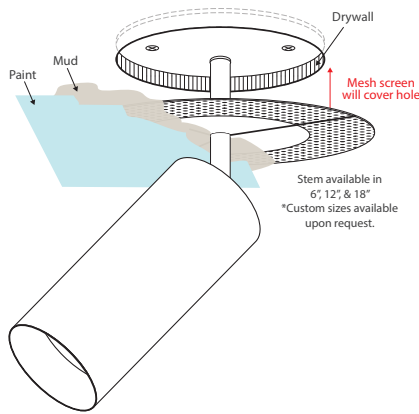

## Stem Option

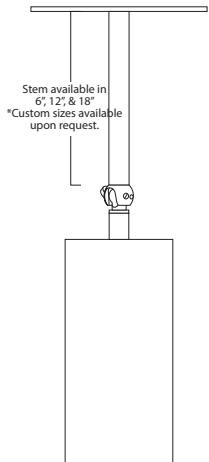

## Remote Mount Driver with Remodel Flat Canopy

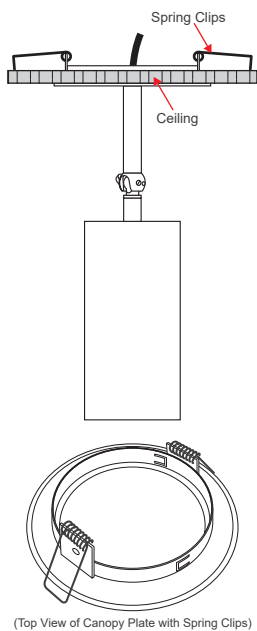

## 2" Pipe Clamp

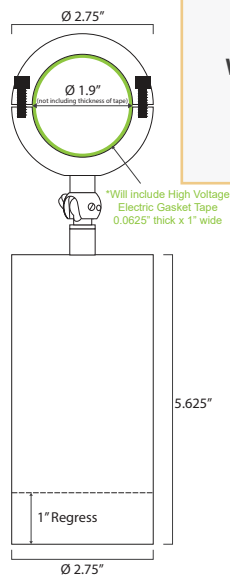

## Flat Canopy Mount in Line Transformer

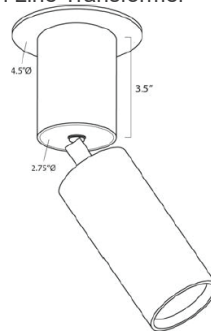

## New Construction

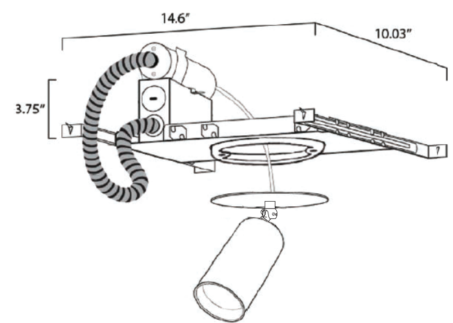

## Housing

- 100% aluminum construction

## Housing Finish

- White, black or pewter power coat finish
- 3300+ Custom Power Coat Finishes

## Electrical

- Optional - 12V AC remote class 2
- Optional - 12V or 24 DC remote class 2
- 100V, 120V, 230V, 277V or 347V

## LED

- 3,000 maximum milliamp rated CREE LED
- Operates between 450 to 1200 milliamps
- L70 life = 100,000 hr.+

## LED Driver

- D – 2 wire forward phase .01% LED driver fade to off glow to on
- ED – 2 wire reverse phase 1% LED driver
- DC – 12V or 24V
- 0-10V – 3 wire 1% LED driver
- Absolute Light – Remote mount class 2 48V din rail .001% LED system
- 16-bit RMD DMX – 65,536 dimming steps fade to off glow to on

## Optics

- TIR discrete injection molded polycarbonate precision LED optic
- 45-degree vertical cut off

## Trim

- Hydro form reflector - no spin marks

## Trim Finish

- Specular Aluminum Anodized
- Matt Aluminum Anodized

## Level Plane and Trimless Installation

- Available in trimless 1/2" recessed, trimless and level plane

## Certification

- UL Damp Listed – IP 52

## Warranty

- 5 Year – ED, 0-10V, DMX and colored LED fixtures
- 7 Year – D and White LED fixtures

# SMR1-202-PAR20-CM

3" Adjustable Center Mount

Project Name:		Type:	
Catalog Number:		Date:	

### Wattage & Lumen Output

**700/750 Milliamps - 1200 Lumens**  
 16W ON/OFF  
 18W MLV <1% Dimming

**1000/1050 Milliamps - 1800 Lumens**  
 24W ON/OFF  
 28W MLV <1% Dimming

**1200 Milliamps - 2000 Lumens**  
 28W MLV <1% Dimming  
 ON/OFF  
 0-10V 1%  
 Lutron  
 DMX

### 3 Step CREE XPL2 LED

Kelvin-CRI	Multiplier
27K-80+ CRI	1
27K-90+ CRI	0.80
30K-80+ CRI	1
30K-90+ CRI	0.85
35K-80+ CRI	105
35K-90+ CRI	0.9
40K-80+ CRI	109
50K-80+ CRI	109
65K-80+ CRI	105

80+ = 84 CRI  
 90+ = 94 CRI

### Narrow Spot 14°

2'	5,051 fc	0.5'
4'	1,263 fc	1.0'
6'	561 fc	1.4'
8'	316 fc	1.9'
10'	202 fc	2.4'
12'	140 fc	2.9'

28W PAR20 - 1,638 lm

### Spot 19°

2'	2,793 fc	0.7'
4'	698 fc	1.4'
6'	310 fc	2.0'
8'	175 fc	2.7'
10'	112 fc	3.4'
12'	78 fc	4.1'

28W PAR20 - 1,865 lm

### Narrow Flood 22°

2'	2,014 fc	0.8'
4'	504 fc	1.5'
6'	224 fc	2.3'
8'	126 fc	3.1'
10'	81 fc	3.9'
12'	56 fc	4.6'

28W PAR20 - 1,785 lm

### Flood

2'	fc	'
4'	fc	'
6'	fc	'
8'	fc	'
10'	fc	'
12'	fc	'

28W PAR20 - 1,721 lm

### Intensity Summary (cd)

Gamma	All Planes	Flux (lm)
0	20206	
5	13883	1000
10	4389	
15	921	334
20	336	
25	210	99
30	149	
35	117	75
40	102	
45	81	65
50	73	
55	49	47
60	41	
65	15	17
70	1	
75	0	0
80	0	
85	0	
90	0	

### Intensity Summary (cd)

Gamma	All Planes	Flux (lm)
0	11174	
5	9332	519
10	5281	
15	2307	475
20	977	
25	422	166
30	220	
35	144	71
40	112	
45	92	50
50	72	
55	48	26
60	41	
65	14	5
70	2	
75	1	1
80	0	
85	0	0
90	0	

### Intensity Summary (cd)

Gamma	All Planes	Flux (lm)
0	8057	
5	6932	579
10	4463	
15	2316	650
20	1093	
25	535	261
30	300	
35	194	126
40	146	
45	118	91
50	88	
55	58	56
60	50	
65	14	20
70	3	
75	1	1
80	1	
85	0	0
90	0	

### Intensity Summary (cd)

Gamma	All Planes	Flux (lm)
0	3157	
5	3048	281
10	2720	
15	2189	597
20	1558	
25	989	454
30	564	
35	320	207
40	181	
45	105	85
50	67	
55	49	45
60	39	
65	28	28
70	20	
75	17	18
80	13	
85	6	7
90	0	

### Zonal Flux and Percentages

Zone	Flux (lm)	%Luminaire
0-30	1433	87.5
0-40	1508	92.1
0-60	1620	98.9
0-90	1638	100.0
40-90	130	7.9
60-90	18	1.1
90-180	0	0.0
0-180	1638	100.0

### Zonal Flux and Percentages

Zone	Flux (lm)	%Luminaire
0-30	1635	90.6
0-40	1729	94.6
0-60	1846	99.6
0-90	1865	100.0
40-90	136	5.4
60-90	19	0.4
90-180	0	0.0
0-180	1865	100.0

### Zonal Flux and Percentages

Zone	Flux (lm)	%Luminaire
0-30	1490	83.5
0-40	1616	90.5
0-60	1763	98.8
0-90	1785	100.0
40-90	169	9.5
60-90	22	1.2
90-180	0	0.0
0-180	1785	100.0

### Zonal Flux and Percentages

Zone	Flux (lm)	%Luminaire
0-30	1332	77.4
0-40	1539	89.4
0-60	1668	96.9
0-90	1721	100.0
40-90	182	10.6
60-90	53	3.1
90-180	0	0.0
0-180	1721	100.0

### All planes - Solid (cd)

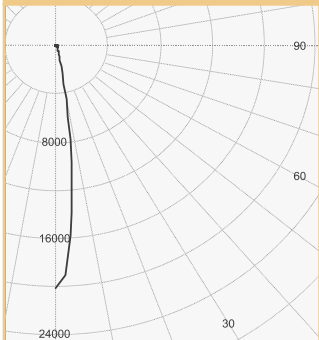

### All planes - Solid (cd)

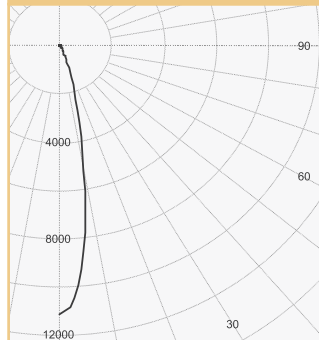

### All planes - Solid (cd)

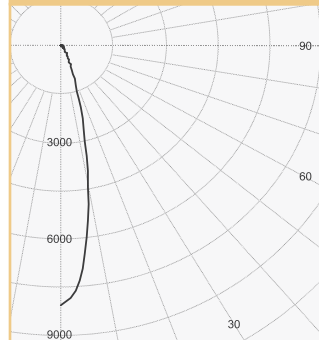

### All planes - Solid (cd)

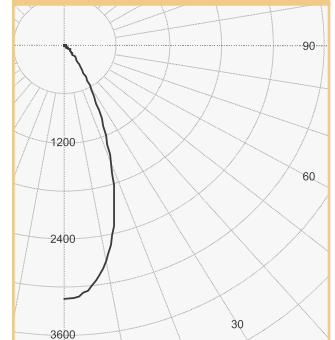

Project Name:		Type:	
Catalog Number:		Date:	

Clarté Lighting 3000K 80+ CRI Color Metrics

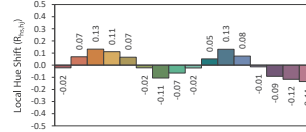
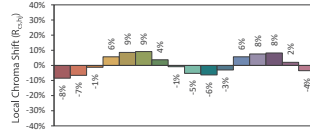
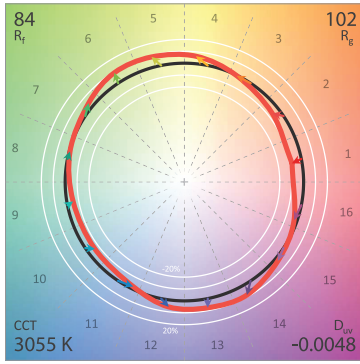

CIE 13.3-1995 (CRI)  
 R<sub>a</sub> 86  
 R<sub>g</sub> 29

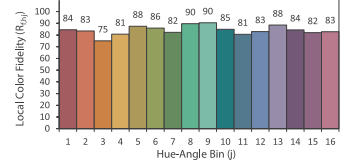
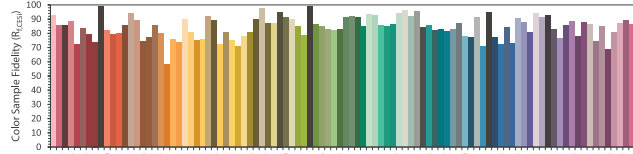

Clarté Lighting 3000K 90+ CRI Color Metrics

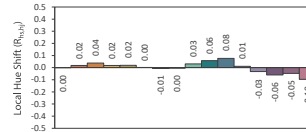
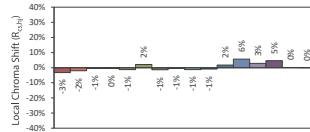
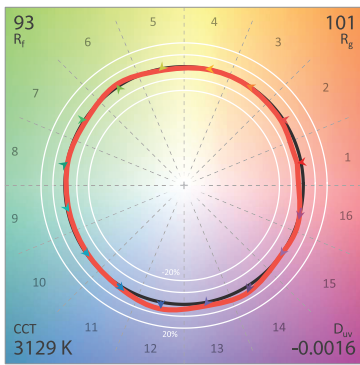

CIE 13.3-1995 (CRI)  
 R<sub>a</sub> 95  
 R<sub>g</sub> 74

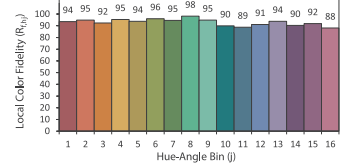
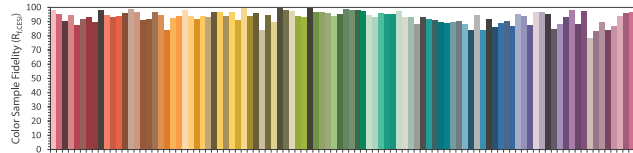

Clarté Lighting 3000K 90+ CRI Halogen Lens (H) Color Metrics

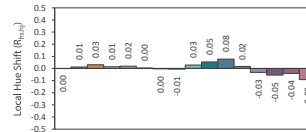
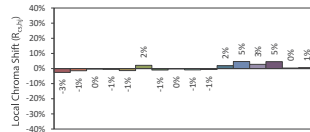
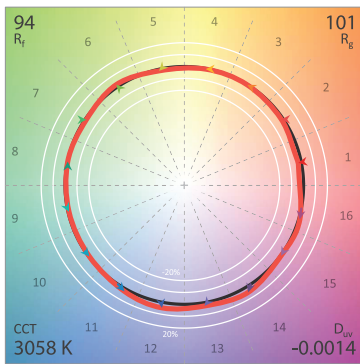

CIE 13.3-1995 (CRI)  
 R<sub>a</sub> 96  
 R<sub>g</sub> 79

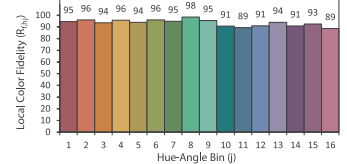
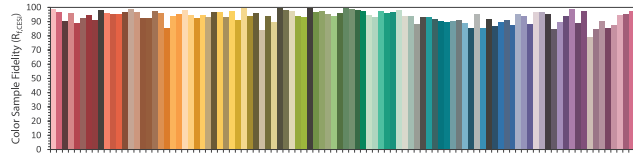

Clarté Lighting 3000K 90+ CRI Dimmed Halogen Lens (DH) Color Metrics

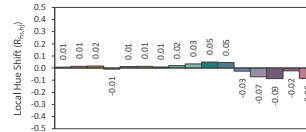
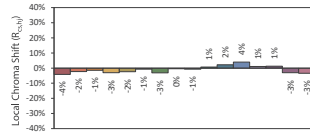
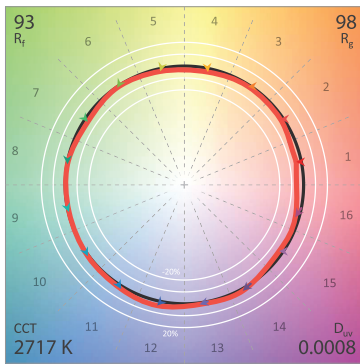

CIE 13.3-1995 (CRI)  
 R<sub>a</sub> 95  
 R<sub>g</sub> 64

