

RS1-187-PAR8

Adjustable or Fixed Square Lipstick

Project Name:		Type:	
Catalog Number:		Date:	

Trimless 1/2" Recessed



Recessed with Trim



Optical Reducer Sleeve

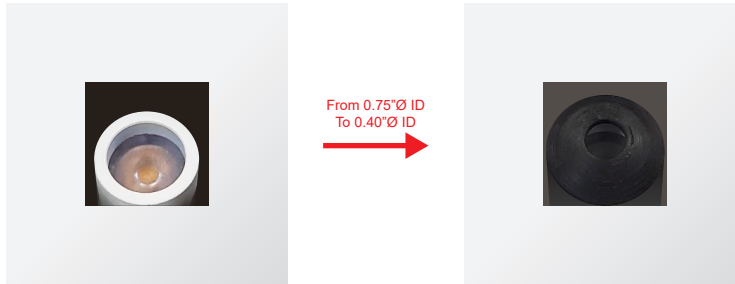

Fixed or Shower Trim

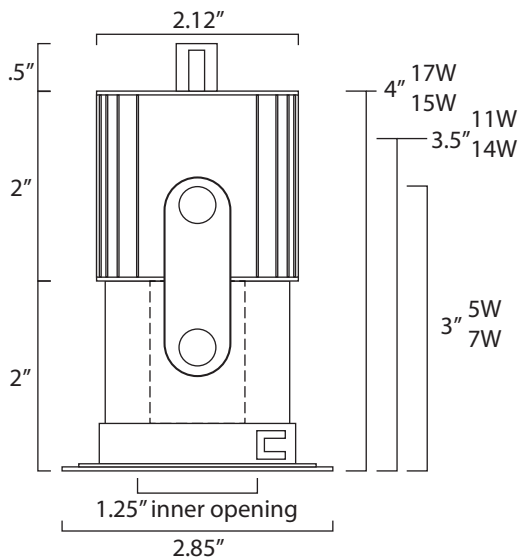

Fixed Wall Wash

Same Dimensions as Fixed

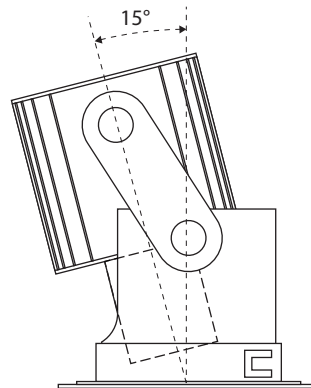

Adjustable

Same Dimensions as Fixed

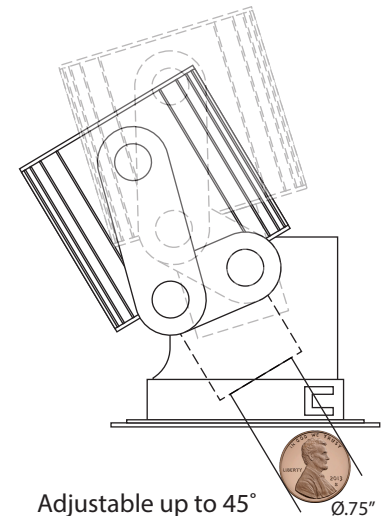

Key Features

- 1.5" ID - 2.91" OD
- Adjustable up to 50°
- Adjustable Recessed or Semi-Recessed
- Fixed 1/2" Recessed Trimless
- 365° Rotation
- IC or NON IC version
- Remote Transformer Optoin
- .02" Uber Thin Trim Lip
- Over 10,000+ fixture custom color finish options
- 100,000+ L70 life

LED Source Details

- CREE XHP50 LED maximum rating = 1,500mA
- Fixture operating milliamp range = 300mA to 700mA.
- Operating 15% to 38% of rated value 20% to 47%
- Fixture wattage range = 5W to 17W
- Fixture delivered lumens = 500 to 1,150 lumens

Patent No.: US 10,208,928 B1

Last revised: 05/18/2026

RS1-187-PAR8

Adjustable or Fixed Square Lipstick

Project Name:		Type:	
Catalog Number:		Date:	

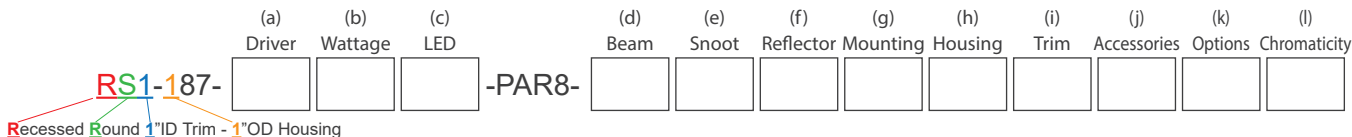

(a) Driver Options

- D = 0.1% MLV 12V AC Dimming (2 wire)
- E = ON/OFF (Electronic)
- ED = 1% Electronic Reverse Phase Dimming (2 wire)
- 12V AC = 0.1% PWM AC Remote Magnetic Dimming (2 wire)
- 24V DC = 0.1% PWM DC Remote Magnetic Dimming (2 wire)
- 0-10V* = Remote Mount 0-10V driver for single fixture (4 wire)
- 0-10V 2 = Remote Mount 0-10V driver for up to 2 fixtures (4 wire)
- 0-10V 3 = Remote Mount 0-10V driver for up to 3 fixtures (4 wire)
- 0-10V 4** = Remote Mount 0-10V driver for up to 4 fixtures (4 wire)
- DALI2 = 0.1% Digital Addressable Lighting Interface V2
- DALI2-4*** = 0.1% Digital Addressable Lighting Interface V2 (4 fixture)
- RDM DMX = 0.001% 16 Bit, 4-Channel Dimming (2 wire with CAT5)
- ABS = 0.001% Absolute Light Dimming (use with RGBW)
- ABSX = 0.001% DMX Absolute Light Dimming (use with RGBW)

*Remote 0-10V LED driver operates single fixture up to 18' away 18ga and 50' away 12ga
 **Remote 0-10V LED driver operates up to 4 fixtures up to 18' away 18ga and 50' away 12ga
 ***Operates up to 4 recessed LED light fixtures with remote LED driver

(b) Wattage Options

- 5W (500 Lumens) = ON/OFF, 0-10V 1%, DMX, ED*
- 7W (500 Lumens) = MLV <1% Dimming
- 10W (1000 Lumens) = ABS
- 11W (525 Lumens) = ON/OFF, 0-10V 1%, ED*
- 14W (525 Lumens) = MLV <1% Dimming, DMX

*Only with no accessories.

(c) Lamp Type Options

X4LED = Cree XHP50 LED = 50+% brighter than XLED (available in spot, narrow flood, and flood)

(d) Beam Options

- SP = Spot
- FL = Flood
- NFL = Narrow Flood

(e) Snoot Color Options

- BLKS = Black Snoot
- WHTS = White Snoot
- PWTS = Pewter Snoot

(f) Reflector/Trim Lip Color Options

- WHT/WHT = White Reflector/White Trim Lip
- WHT/BLK = White Reflector/Black Trim Lip
- BLK/BLK = Black Reflector/Black Trim Lip
- BLK/WHT = Black Reflector/White Trim Lip
- PWT/PWT = Pewter Reflector/Pewter Trim Lip
- PWT/WHT = Pewter Reflector/White Trim Lip
- PWT/BLK = Pewter Reflector/Black Trim Lip

(g) Mounting Options

- ADJ = Adjustable
- FX = Fixed
- WOS = Wires Out the Side (reduces height by 0.5")
- FWW = Fixed Wall Wash
- ST = Shower Trim

(h) Fixture Housing Options





Non-IC Rated:
 RMT = No housing, no frame, remote transformer spring clip loaded trim
 NIC = Frame and junction box to be used with trim version

IC Rated:
 AH = 8" x 8" Architectural housing to be used with trimmed or level plane installation

(i) Trim Type

- T = Trimmed
- T1 = Level Plane
- T2 = Trimless 1/2" Recessed
- TLW = Trimless Wood

(j) Optical and Accessory Options

- LS = Lens Softener - +20% increase in beam width. Shields optical face visually. Softens edges of beam. 
- LSL = Linear Spread Lens - Horizontal or vertical beam elongation. 
- WFL = Wide Flood Lens - Wall washing increases the beam by 50% width with elimination of center beam. 
- LV* = Louver - Small black hexcel louver eliminates all surface brightness. Creates stronger vertical cut off with -20% beam width. 
- H = Halogen - 100K warmer. 2700k to 2500K
- DH = Dimmed Halogen - 400K warmer. 2700k to 2300K 

*Units should not be run for more than 12hrs when using LV or CHL accessories.

(k) Options

- RMT7 = 7Watt 12V AC MLV Step Down Transformer
- RMT14 = 14Watt 12V AC MLV Step Down Transformer
- RMT17 = 17Watt 12V AC MLV Step Down Transformer
- RMT60 = 60Watt 12V AC MLV Step Down Transformer
- RMT150 = 150Watt 12V AC MLV Step Down Transformer
- RMT300 = 300Watt 12V AC MLV Step Down Transformer
- 12V = DC
- 24V = DC
- 120V = 120VAC 60Hz (Standard)
- 230V = 230VAC 50Hz
- 277V = 277VAC 60Hz
- 347V = 347VAC 60Hz
- EMG = 90min Emergency Back-Up Battery
- TB = DMX 5-pin Plug-in Terminal Block
- RET* = Bi-pin whip to plug Clarté LED trim module into existing MLV transformed recessed halogen MR16 fixtures.
- 0.4" = 0.4" Optical Reducer Sleeve
- 80+ = CRI over 80
- 90+ = CRI over 90
- EXT = Exterior zinc primer with zinc infused paint

*Eliminate the need to install new 12V AC step down transformer, Clarté LED trim installs like changing a lamp.

(l) Color Temperature Options

- | | |
|--|-----------------------------------|
| White LED | Colored/Themed LED |
| 27K = 2700 Kelvin (incandescent color) | RGBW3K* = Red, Green, Blue, White |
| 30K = 3000 Kelvin (halogen color) | RGBW4K* = Red, Green, Blue, White |
| 35K = 3500 Kelvin (warm incandescent) | |
| 40K = 4000 Kelvin (cool incandescent) | |
| 50K = 5000 Kelvin (day white) | |

*Must utilize DMX fixture option

RS1-187-PAR8

Adjustable or Fixed Square Lipstick

Project Name:		Type:	
Catalog Number:		Date:	

Non-IC: No Housing Remote Transformer Remodel - Trimmed

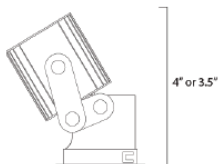

Non-IC: No Housing Framed Fixture with J-Box - Trimmed

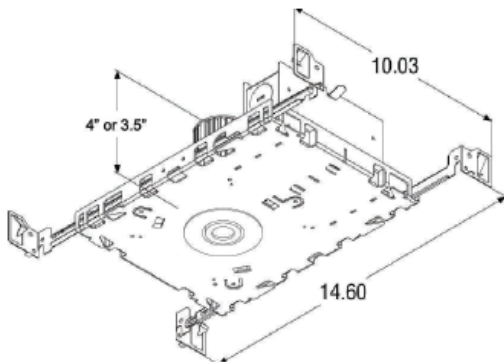

IC: Architectural Housing - Trimless, Level Plane or 1/2\"/>

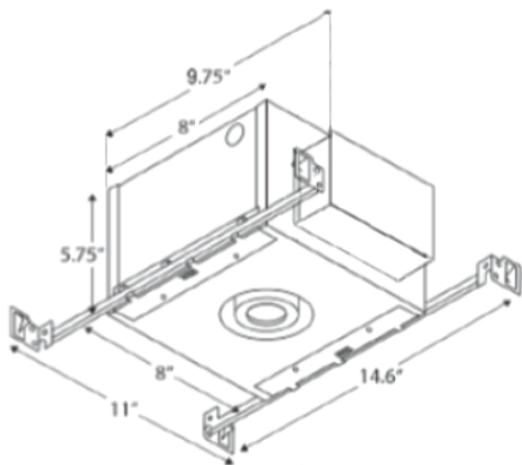

Housing

- 100% aluminum construction
- IC housing with hinged 4" x 6" side access panel to j-box & LED driver

Electrical

- IC or NON-IC fixture housing
- Optional - 12V AC remote class 2
- Optional - 12V or 24 DC remote class 2
- 100V, 120V, 230V, 277V or 347V

LED

- 3,000 maximum milliamp rated CREE LED
- Operates between 450 to 1200 milliamps
- L70 life = 100,000 hr.+

LED Driver

- D – 2 wire forward phase .01% LED driver fade to off glow to on
- ED – 2 wire reverse phase 1% LED driver
- DC – 12V or 24V
- 0-10V – 3 wire 1% LED driver
- Absolute Light – Remote mount class 2 48V din rail .001% LED system
- 16-bit RMD DMX – 65,536 dimming steps fade to off glow to on

Optics

- TIR discrete injection molded polycarbonate precision LED optic
- 45-degree vertical cut off

Trim

- .02" thin trim lip
- Hydro form reflector - no spin marks

Trim Finish

- Specular Aluminum Anodized
- Matt Aluminum Anodized
- White, Black or Pewter Powder Coat Paint
- 3300+ Custom Power Coat Paint Colors
- 7000+ Custom Wet Paint Colors

Level Plane and Trimless Installation

- Available in 1/2" recessed trimless and level plane

Installation

- Accommodates ceiling thickness up to 2.5"
- Universal adjustable 24" adjustable hangar bars

Certification

- UL Damp Listed – IP 52 – Open trim
- UL Wet Listed – IP 65 – Lensed trim

Warranty

- 5 Year – ED, 0-10V, DMX and colored LED fixtures
- 7 Year – D and White LED fixtures

3 Trim Installation Options



RS1-187-PAR8

Adjustable or Fixed Square Lipstick

Project Name:		Type:	
Catalog Number:		Date:	

Wattage & Lumen Output			
300 Milliamps - 500 Lumens		700 Milliamps	
5W	ON/OFF	10W	Red - Up to 150 Lumens
	0-10V 1% Dimming		Green - Up to 150 Lumens
	ED		Blue - Up to 150 Lumens
7W	MLV <1% Dimming		White - Up to 300 Lumens
525 Milliamps - 900 Lumens		700 Milliamps - 1150 Lumens	
11W	ON/OFF	15W	ON/OFF
	0-10V 1% Dimming		0-10V 1% Dimming
	ED		ED
14W	MLV <1% Dimming	14W	MLV <1% Dimming
			DMX

3 Step CREE XPL2 LED	
Kelvin-CRI	Multiplier
27K-80+ CRI	1
27K-90+ CRI	0.80
30K-80+ CRI	1
30K-90+ CRI	0.85
35K-80+ CRI	105
35K-90+ CRI	0.9
40K-80+ CRI	109
50K-80+ CRI	109
65K-80+ CRI	105
80+ = 84 CRI	
90+ = 94 CRI	

RGBW V2 Light Output Luminous Flux		
Clarté Lighting offers 100% of fixtures in optional RGBW3K or RGBW4K		
	700 mA RGBW3K	700 mA White 3K
Red	160	
Green	310	
Blue	46	
White	260	
Total	776	907

*RGBW Fixtures are designed to not operate with all 4 colors at 100% of light for more than 24hrs continuously and suggest operating 55% or less of all 4 colors ON to ensure optimum thermal life of the RGBW LED.

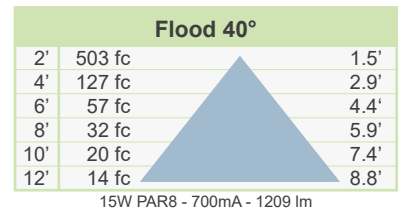
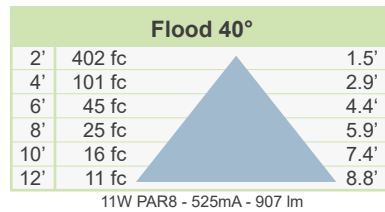
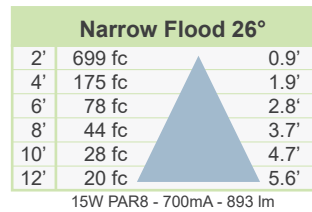
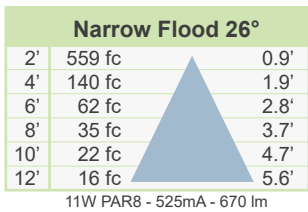

Zonal Flux and Percentages

Zone	%Luminaire
0-20	63
0-30	83.3
0-40	89.8
0-60	95.8
0-80	99.2
0-90	100
10-90	77.9
20-40	26.7
20-50	30.6
40-70	8
60-80	3.4
70-80	1.4
80-90	0.8

Zonal Flux and Percentages

Zone	%Luminaire
0-20	47.3
0-30	74.3
0-40	88.5
0-60	97.5
0-80	99.5
0-90	100
10-90	87.1
20-40	41.2
20-50	48.7
40-70	10.1
60-80	2
70-80	0.9
80-90	0.5

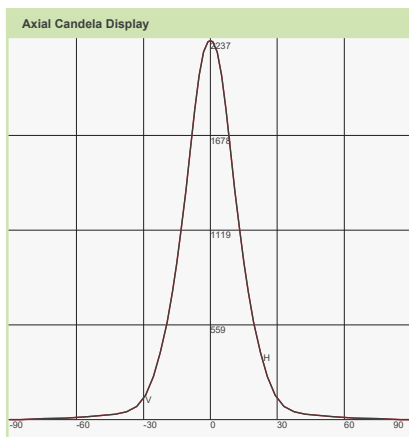

Maximum Candela = 2237 Located At Horizontal Angle = 0, Vertical Angle = 0
 H - Horizontal Axial Candela
 V - Vertical Axial Candela

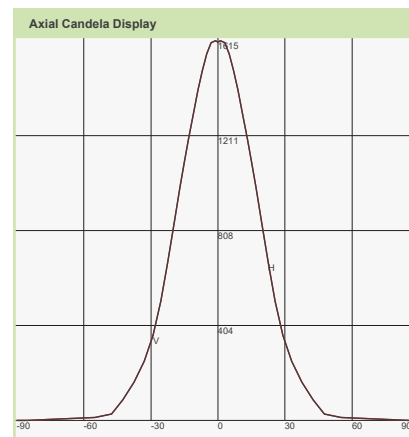

Maximum Candela = 1615 Located At Horizontal Angle = 0, Vertical Angle = 0
 H - Horizontal Axial Candela
 V - Vertical Axial Candela

Project Name:		Type:	
Catalog Number:		Date:	

Clarté Lighting 3000K 80+ CRI Color Metrics

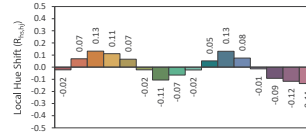
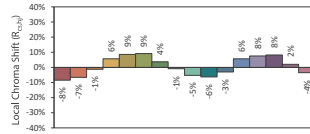
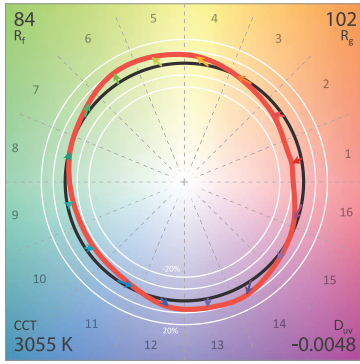

CIE 13.3-1995 (CRI)
 R_a 86
 R_g 29

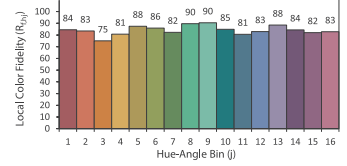
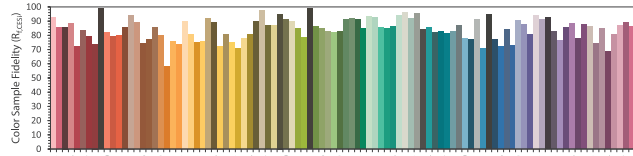

Clarté Lighting 3000K 90+ CRI Color Metrics

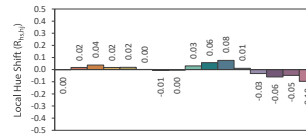
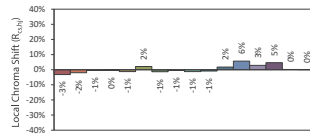
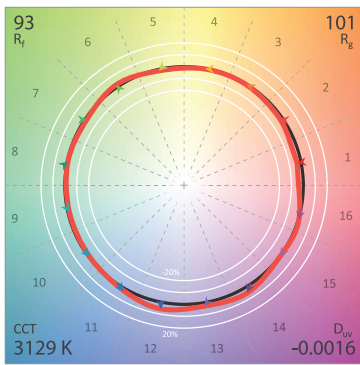

CIE 13.3-1995 (CRI)
 R_a 95
 R_g 74

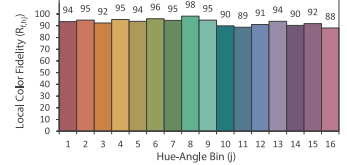
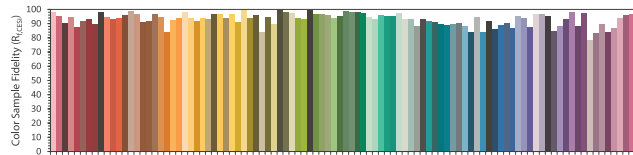

Clarté Lighting 3000K 90+ CRI Halogen Lens (H) Color Metrics

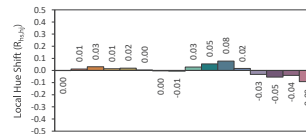
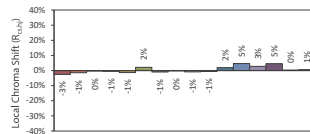
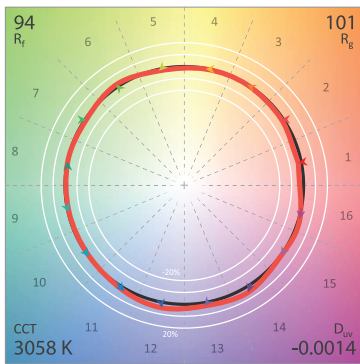

CIE 13.3-1995 (CRI)
 R_a 96
 R_g 79

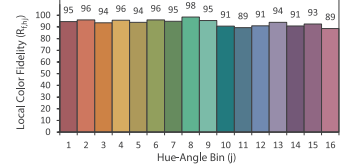
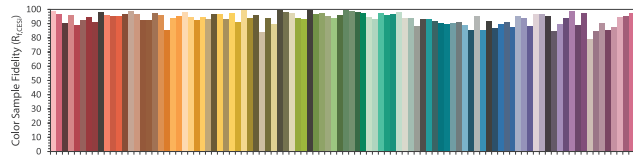

Clarté Lighting 3000K 90+ CRI Dimmed Halogen Lens (DH) Color Metrics

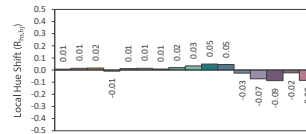
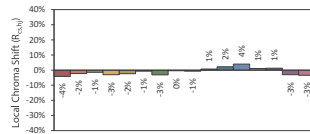
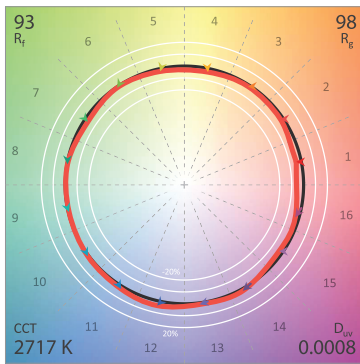

CIE 13.3-1995 (CRI)
 R_a 95
 R_g 64

