

SDT-838-PAR38

Surface Directional Track

Project Name:		Type:	
Catalog Number:		Date:	

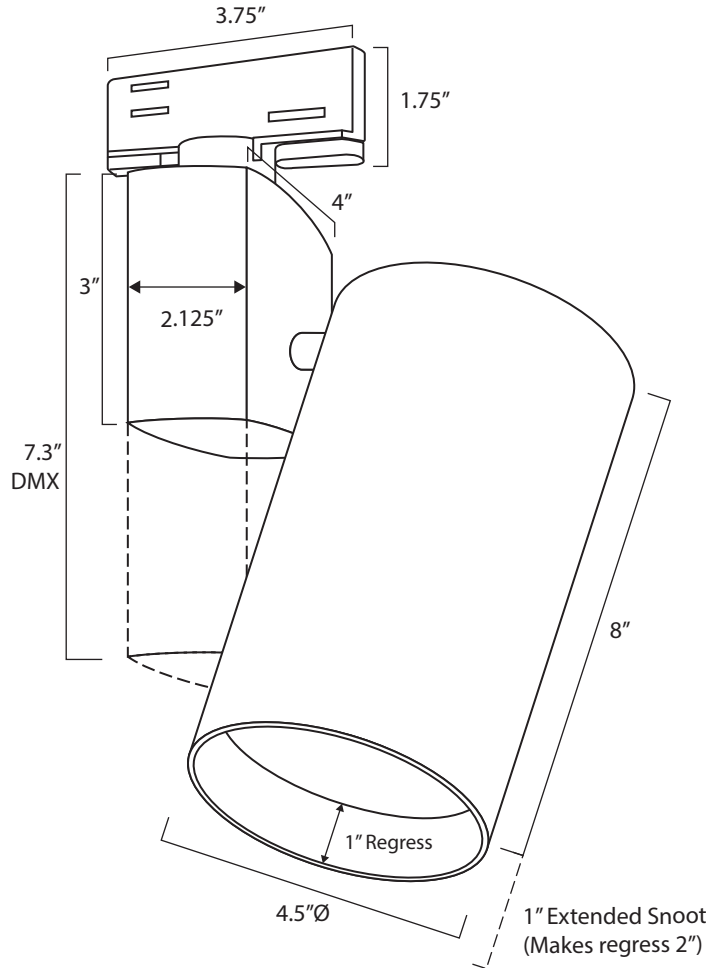
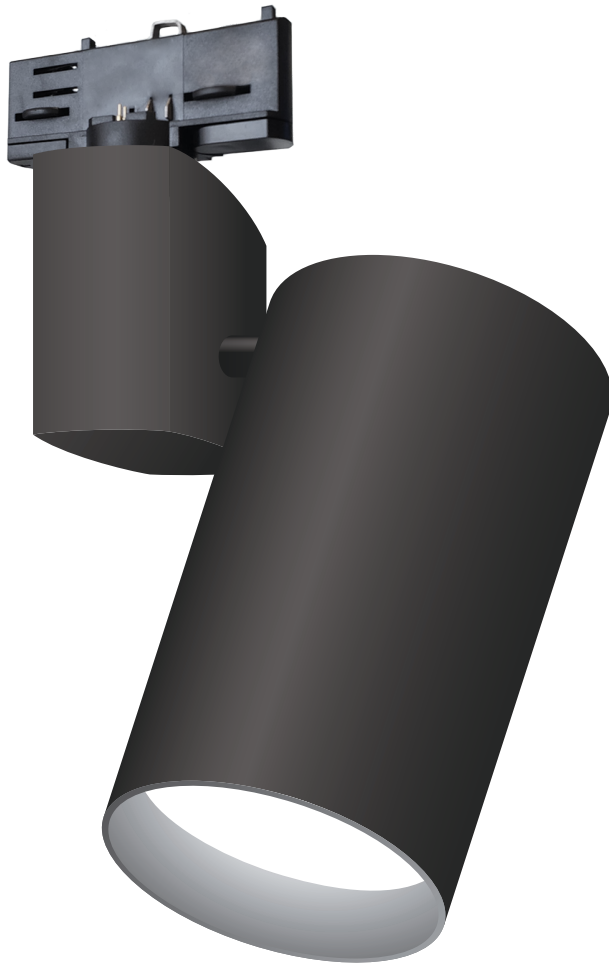

Key Features

- 4.5" OD
- Up to 4 accessories
- Remote transformer option
- Track adapter options
 - 1C - H type 1 circuit
 - 12C - 120V
 - 12C - 277V
- Over 10,000+ fixture custom color finish options
- 100,000+ hr L70 life
- Wall or ceiling mount
- **See Page 3 for C-Clamp Option**

LED Source Details

- CREE XPL2 LED maximum rating 3,000 mA
- Fixture operating milliamps = 1,500 mA
 - Fixture Wattage Range = 64W to 68W
 - Fixture Delivered Lumens = 4,500 lumens

Patent Pending

Last revised: 05/18/2026

Clarté Lighting

SDT-838-PAR38

Surface Directional Track

Ordering

Project Name:		Type:	
Catalog Number:		Date:	

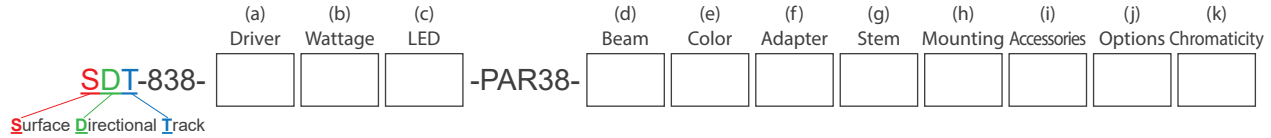

(a) Driver Options

- E = ON/OFF (Electronic)
- D* = MLV Forward Phase .1% Dimming (2 wire)
- ED = Electronic Forward and Reverse Phase 1% Dimming (2 wire)
- 0-10V = 1% 0-10V Analog Dimming
- DALIV2 = 1% DALIV2 Digital Dimming
- RDM DMX = 8 or 16 Bit, 4 Channel (2 wire with CAT5)

*MLV driver for use with forward phase, SCR, or Triac dimmers ONLY.

(b) Wattage Options

- 64W = 1500 milliamps/4500 lumens, ON/OFF, 0-10V
- 68W = 1200 milliamps/3600 lumens, MLV
- 72W = 600 milliamps/3000 lumens, RDM DMX RGBW

(c) LED Type Options

- CREE XPL2 high intensity = narrow spot (NSP)
- CREE XPL2 high density = spot (SP), narrow flood (NFL), and flood (FL)

(d) Beam Options

- NSP = Narrow Spot
- SP = Spot
- NFL = Narrow Flood
- FL = Flood

(e) Fixture Color Options

- BLK = Black
- WHT = White
- PWT = Pewter
- PWTB = Pewter Fixture with Piano Black Interior Snoot
- Select Custom Color (Review Website for Over 3,300 Color Options)

(f) Track Adapter Options

- 120 = 2-Circuit, 120V
- 277 = 2-Circuit, 277V

(g) Stem Options







- S6* = Stem Size 6"
- S12* = Stem Size 12"
- S18 = Stem Size 18"
- S24 = Stem Size 24"
- CS = Custom Stem (up to 96")

*Track only 6" or 12"

(h) Mounting Options

- CLP = C-Clamp
- 2PC = 2" Pipe Clamp
- FCPS = Flat Canopy Plate with Stem
- CLPD = C-Clamp + Plug MLV
- FCP = Flat Canopy Plate

(i) Optical and Accessory Options

- LS = Lens Softener - +20% increase in beam width. Shields optical face visually. Softens edges of beam. 
- LSL = Linear Spread Lens - Horizontal or vertical beam elongation. 
- WFL = Wide Flood Lens - Wall washing increases the beam by 50% width with elimination of center beam. 
- LV = Louver - Small black hexcel louver eliminates all surface brightness. Creates stronger vertical cut off with -20% beam width. 
- CHL = Cross Hiar Louver 
- H = Halogen - 150K warmer. 2700k to 2550K 
- DH = Dimmed Halogen - 300K warmer. 2700k to 2400K 

(j) Options

- 120V = 120VAC 60Hz (Standard)
- 230V = 230VAC 50Hz (Used in conjunction with 230V track)
- 277V = 277VAC 60Hz (Used in conjunction with 277V track)
- BD = Barn Doors
- ES = Extended Snoot (Optic Snoot Regress Increased to 1 1/2")
- TSN = Tapered Snoot
- C* = C-Clamp
- C/LEADS = C-Clamp w Leads/No Coil Grounded Plug
- PL* = Coil Grounded Plug
- PL/HWD = Coil Grounded Cord/No Plug
- TBL = Threaded Butterfly Lock
- DMXC = DMX C-Clamp and CAT5
- DMX* = .39% to 100% milliamp constant voltage LED driver, dip switch addressable, 3 channel for 27K & 30K, 4 channel for RGBW, CAT5 in & out*
- 80+ = CRI over 80
- 90+ = CRI over 90

*DMX is required in RGBA or in any 2 circuits or more.
Custom colors available - Consult factory for more details

(j) Color Temperature Options

White LED

- 22K* = 2200 Kelvin (candlelight color)
- 27K = 2700 Kelvin (incandescent color)
- 30K = 3000 Kelvin (halogen color)
- 35K = 3500 Kelvin (warm incandescent)
- 40K = 4000 Kelvin (cool incandescent)
- 50K = 5000 Kelvin (day white)
- 60K = 6500 Kelvin (12 noon sunlight)

Colored/Themed LED

- UV275** = 275 NM UV virus sterilizer
- UV365*** = 365 NM UV black light
- UV390*** = 390 NM UV black light
- Blue*** = 465 - 485 NM wavelength
- Green*** = 520 - 535 NM wavelength
- Amber*** = 585 - 595NM wavelength
- Red*** = 620 - 630 NM wavelength
- Photo Red*** = 650 - 670 NM wavelength
- RGBW3K**** = Red, Green, Blue, White
- RGBW4K**** = Red, Green, Blue, White

*1050 mA or less

**500 mA
***700 mA
****Must utilize DMX @ 700 mA

SDT-838-PAR38

Surface Directional Track

Project Name:		Type:	
Catalog Number:		Date:	

DMX Track Fixture

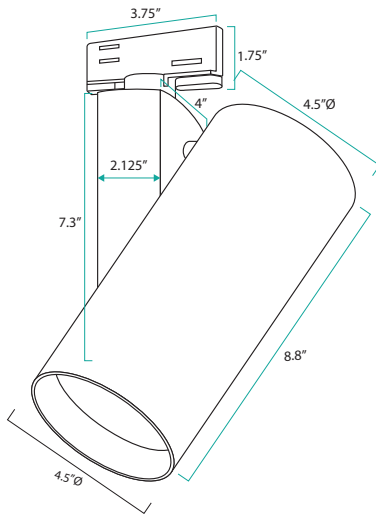

Housing

- 100% aluminum construction

Electrical

- Optional - 12V AC remote class 2
- 120V, 230V or 277V

LED

- 3,000 mA rated CREE XPL2 LED – NSP
- Operating at 1600 milliamps = 53% of maximum rated current

LED Driver

- D – 2 wire forward phase .01% LED driver fade to off glow to on
- ED – 2 wire reverse phase 1% LED driver
- DC – 12V or 24V
- 0-10V – 3 wire 1% LED driver
- 16-bit RMD DMX – 65,536 dimming steps fade to off glow to on

Optics

- TIR discrete injection molded polycarbonate precision LED optic
- 45-degree vertical cut off

Installation

Track Adapter

- 1C - H type single circuit
- 2C 120 - 2 circuit 120V
- 2C 277 – 2 circuit 277V

Certification

- CE – In compliance with EU regulations
- UL Damp Listed – IP 52

Warranty

- 5 Year – ED, 0-10V, DMX and colored LED fixtures
- 7 Year – D and White LED fixtures

DMX C-Clamp and CAT5 Option

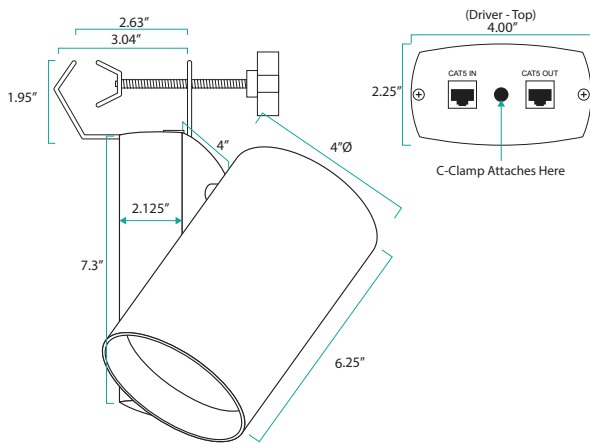

2" Pipe Clamp

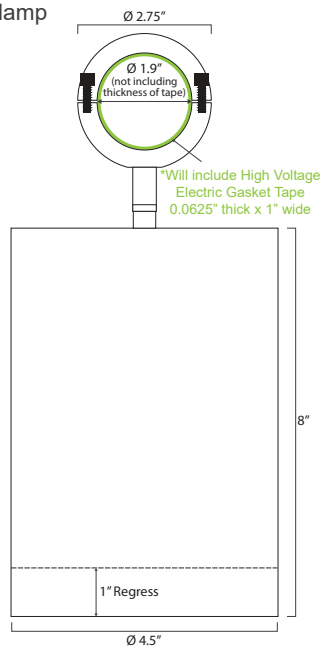

C-Clamp with MLV

Chord Max Length = Approx 16'
Chord Compressed Length = Approx 3'

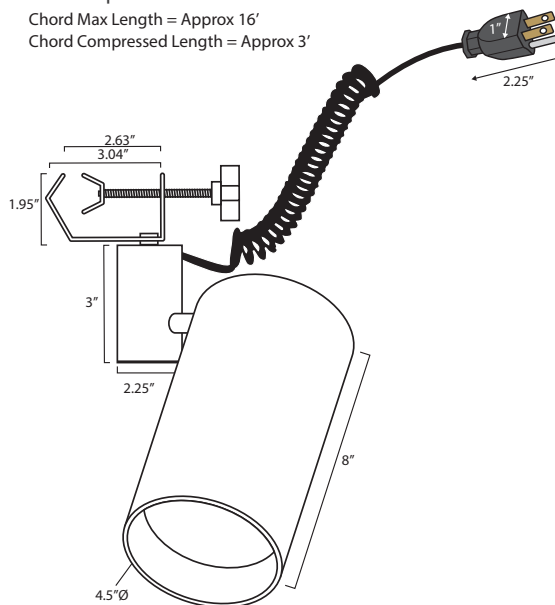

Flat Canopy Plate

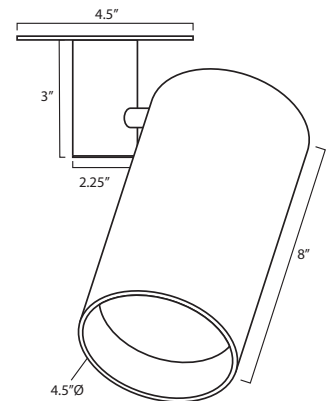

SDT-838-PAR38

Surface Directional Track

Project Name:		Type:	
Catalog Number:		Date:	

Wattage & Lumen Output

1400 Milliamps - 5000 Lumens	
68W	ON/OFF
	0-10V 1% Dimming
	DMX Dimming

3 Step CREE XPL2 LED

Kelvin-CRI	Multiplier
27K-80+ CRI	1
27K-90+ CRI	0.80
30K-80+ CRI	1
30K-90+ CRI	0.85
35K-80+ CRI	105
35K-90+ CRI	0.9
40K-80+ CRI	109
50K-80+ CRI	109
65K-80+ CRI	105
80+ = 84 CRI	
90+ = 94 CRI	

RGBW V2 Light Output Luminous Flux Clarté Lighting offers 100% of fixtures in optional RGBW3K or RGBW4K

	Line Voltage	ABS Light	
	600 mA RGBW3K	700 mA RGBW3K	700 mA White 3K
Red	1728	1920	
Green	3348	3720	
Blue	497	552	
White	2808	3120	
Total	8381	9312	3377

*RGBW Fixtures are designed to not operate with all 4 colors at 100% of light for more than 24hrs continuously and suggest operating 55% or less of all 4 colors ON to ensure optimum thermal life of the RGBW LED.

Narrow Flood 21°

2'	5,157 fc	0.7'
4'	1,289 fc	1.5'
6'	573 fc	2.2'
8'	322 fc	3.0'
10'	206 fc	3.7'
12'	143 fc	4.4'

67W PAR38 - 4,266 lm

Zonal Flux and Percentages

Zone	Flux (lm)	%Luminaire
0-30	3369	79.0
0-40	3739	87.7
0-60	4197	98.4
0-90	4266	100.0
40-90	527	12.3
60-90	69	1.6
90-180	0	0.0
0-180	4266	100.0

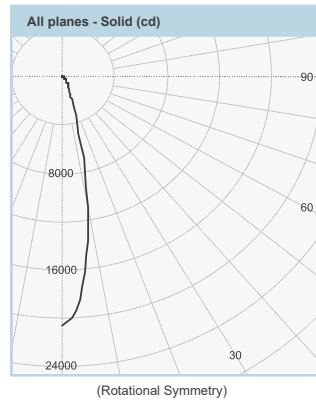

Intensity Summary (cd)

Gamma	All Planes	Flux (lm)
0	20628	
5	17468	1451
10	10916	
15	4848	1396
20	1966	
25	1066	522
30	764	
35	582	370
40	476	
45	381	295
50	291	
55	177	163
60	103	
65	73	65
70	14	
75	3	4
80	1	
85	0	1
90	0	

Project Name:		Type:	
Catalog Number:		Date:	

Clarté Lighting 3000K 80+ CRI Color Metrics

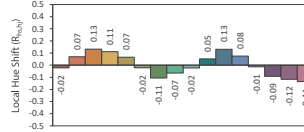
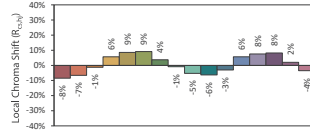
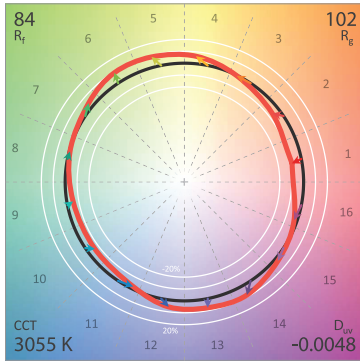

CIE 13.3-1995 (CRI)
 R_a 86
 R_g 29

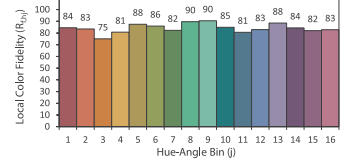
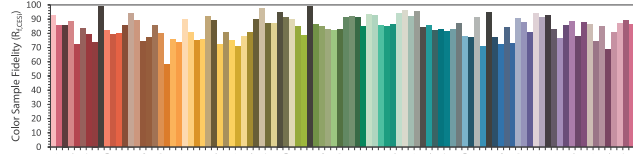

Clarté Lighting 3000K 90+ CRI Color Metrics

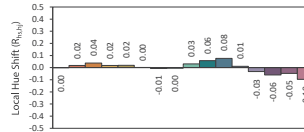
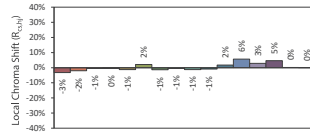
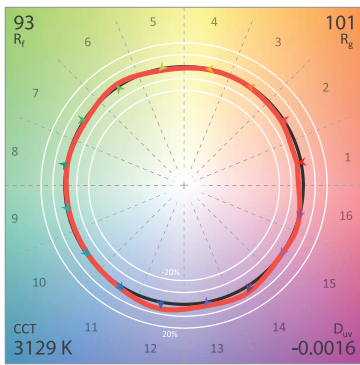

CIE 13.3-1995 (CRI)
 R_a 95
 R_g 74

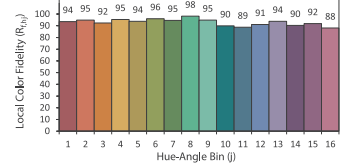
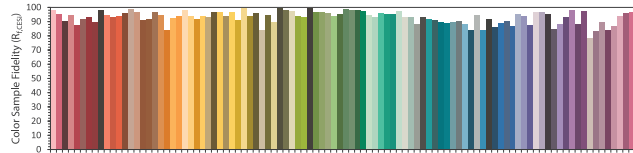

Clarté Lighting 3000K 90+ CRI Halogen Lens (H) Color Metrics

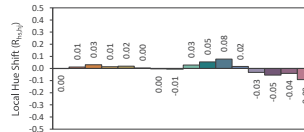
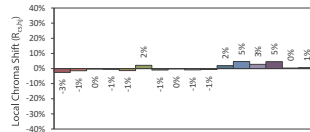
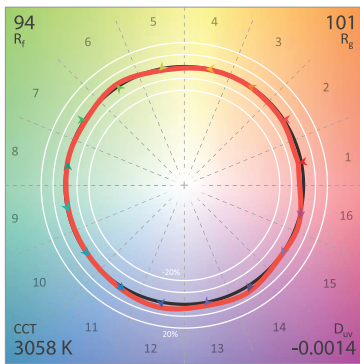

CIE 13.3-1995 (CRI)
 R_a 96
 R_g 79

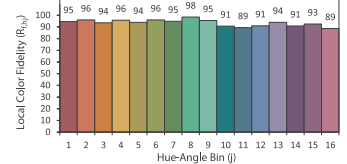
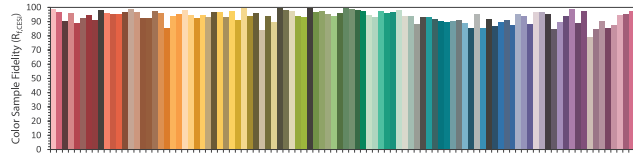

Clarté Lighting 3000K 90+ CRI Dimmed Halogen Lens (DH) Color Metrics

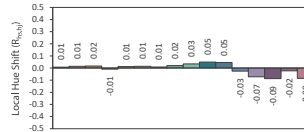
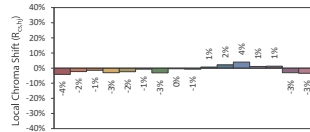
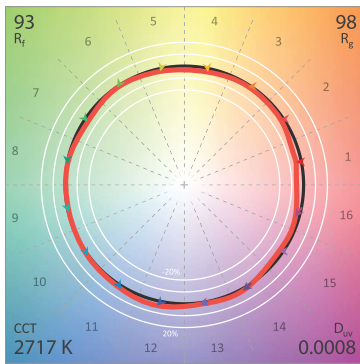

CIE 13.3-1995 (CRI)
 R_a 95
 R_g 64

