

Project Name:		Type:	
Catalog Number:		Date:	

Canopy Plate



Trimless - Plaster



Trimless - Wood

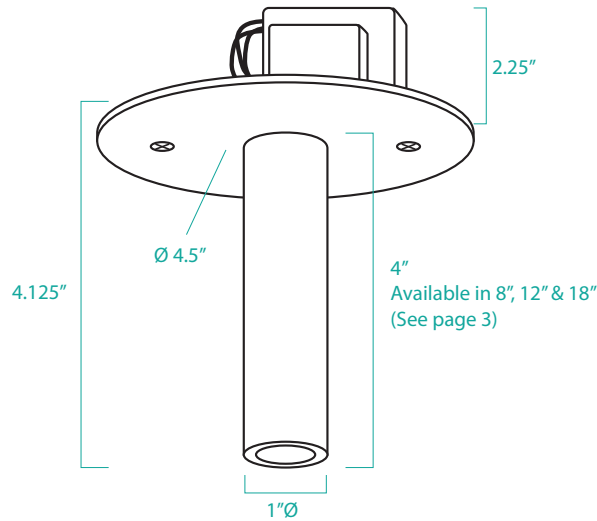

Key Features

- ADA Compliant = 1.625" depth
- 3/4" ID & 1" OD LED Optic
- 4 Beam Spreads – Spot (17°), Narrow Flood (26°) or Flood (40°), Luminosity (50° with Vertical Illumination)
- Class 2 = 12V, 24V or 48V
- Accepts Up to 3 Optical Accessories
- UL = IP66

LED Source Details

CREE XHP50.2 LED maximum rating = 1500 mA

- Operating Range = 350 mA to 525 mA
- Operating 15% to 38% of Rated Value
- Fixture Wattage Range = 5W to 14W
- Fixture Delivered Lumens = 450 to 900 Lumens

Patent No.: US 10,208,928 B1
Other Patents Pending

Last revised: 05/11/2026

Project Name:		Type:	
Catalog Number:		Date:	

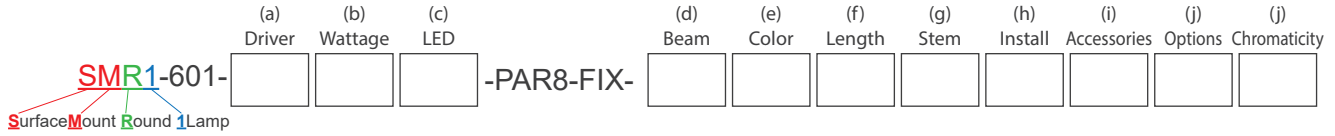

(a) Driver Options

- D = 0.1% MLV 12V AC Dimming (2 wire)
- E = ON/OFF (Electronic)
- ED = 1% Electronic Reverse Phase Dimming (2 wire)
- 12V AC = 0.1% PWM AC Remote Magnetic Dimming (2 wire)
- 24V DC = 0.1% PWM DC Remote Magnetic Dimming (2 wire)
- 0-10V* = Remote Mount 0-10V driver for single fixture (4 wire)
- 0-10V 2 = Remote Mount 0-10V driver for up to 2 fixtures (4 wire)
- 0-10V 3 = Remote Mount 0-10V driver for up to 3 fixtures (4 wire)
- 0-10V 4** = Remote Mount 0-10V driver for up to 4 fixtures (4 wire)
- DALI2 = 0.1% Digital Addressable Lighting Interface V2
- DALI2-4*** = 0.1% Digital Addressable Lighting Interface V2 (4 fixture)
- RDM DMX = 0.001% 16 Bit, 4-Channel Dimming (2 wire with CAT5)
- ABS = 0.001% Absolute Light Dimming (use with RGBW)
- ABSX = 0.001% DMX Absolute Light Dimming (use with RGBW)

*Remote 0-10V LED driver operates single fixture up to 18' away 18ga and 50' away 12ga
 **Remote 0-10V LED driver operates up to 4 fixtures up to 18' away 18ga and 50' away 12ga
 ***Operates up to 4 recessed LED light fixtures with remote LED driver

(b) Wattage Options

- 5W = ED, ON/OFF, 0-10V 1% (350 milliamps), 450 lumens
- 7W = MLV <1% Dimming (350 milliamps), 450 lumens
- 10W = Absolute Light
- 11W = ED, ON/OFF, 900 lumens

(c) LED Type Options

- X4LED = Cree XHP50.2 LED

(d) Beam Options

- SP = Spot 17° NFL = Narrow Flood 26°
- FL = Flood 40° LM = Luminosity Flood 50° Vertical Illumination with 5/8" glow extension

(e) Fixture Color Options

- BLK* = Black
- WHT* = White
- PWT* = Pewter
- Select Custom Color (Review Website for Over 3,300 Color Options)

*Zinc based powder coat paint for weatherization

(f) Fixture Length Options

- L4 = Standard 4" Length L12 = 12" Fixture Length
- L18 = 18" Fixture Length L22 = 22" Fixture Length
- C24 - C60 = Custom Size*

*Select any length between 24" and 60" in whole inch increments







(g) Stem Options

- S6 = Stem Size 6" S18 = Stem Size 18"
- S12 = Stem Size 12" CS = Custom Stem (up to 96" for flat canopy)

(h) Installation Options

- 2CP = 2" Canopy Plate BCPS = Blind Canopy Plate Trimless Stem
- 2.75CP = 2.75" Canopy Plate TLP = Trimless Plaster
- 4.5CP = 4.5" Canopy Plate TLW = Trimless Wood

(i) Optical and Accessory Options

- LS = Lens Softener - +20% increase in beam width. Shields optical face visually. Softens edges of beam. 
- LSL = Linear Spread Lens - Horizontal or vertical beam elongation. 
- WFL = Wide Flood Lens - Wall washing increases the beam by 50% width with elimination of center beam. 
- LV = Louver - Small black hexcel louver eliminates all surface brightness. Creates stronger vertical cut off with -20% beam width. 
- CHL = Cross Hiar Louver 
- H = Halogen - 100K warmer. 2700k to 2500K 
- DH = Dimmed Halogen - 400K warmer. 2700k to 2300K 

(j) Options

- RMT = Remote Driver Other than MLV Step Down Transformer
- RMT14 = 14Watt 12V AC MLV Step Down Transformer
- RMT60 = 60Watt 12V AC MLV Step Down Transformer
- RMT150 = 150Watt 12V AC MLV Step Down Transformer
- RMT300 = 300Watt 12V AC MLV Step Down Transformer
- 120V = 120VAC 60Hz (Standard)
- 230V = 230VAC 50Hz
- 277V = 277VAC 60Hz
- WL = IP66 Wet Listed (Pending)
- EMG = Remote 90min Emergency Back-Up
- 80+ = CRI over 80
- 90+ = CRI over 90

(j) Color Temperature Options

- | | |
|----------------------------------------|-----------------------------------|
| White LED | Colored/Themed LED |
| 27K = 2700 Kelvin (incandescent color) | RGBW3K* = Red, Green, Blue, White |
| 30K = 3000 Kelvin (halogen color) | RGBW4K* = Red, Green, Blue, White |
| 35K = 3500 Kelvin (warm incandescent) | |
| 40K = 4000 Kelvin (cool incandescent) | |
| 50K = 5000 Kelvin (day white) | |
- *Must utilize DMX fixture option

SMR1-601-PAR8-FIX

Fixed Mono Point

Project Name:		Type:	
Catalog Number:		Date:	

Trimless - 2-Part Design, 3D printed ASA plastic threaded insert (must utilize remote ELV or 0-10V power supply)

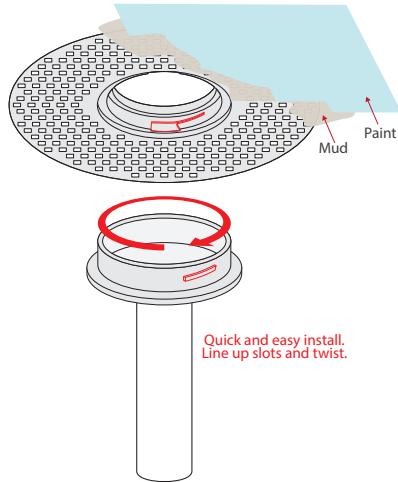

Blind Canopy Trimless Stem, 3D printed ASA plastic mud screen (must utilize remote ELV or 0-10V power supply)

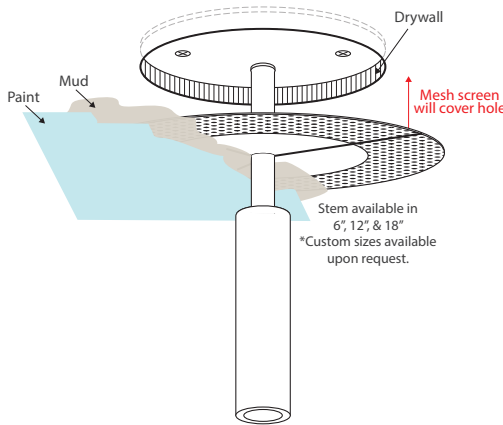

Housing

- 100% aluminum construction

Electrical

- Optional - 12V AC remote class 2
- Optional - 24V DC remote class 2
- 100V, 120V, 230V, 277V or 347V

LED

- CREE XHP50
- 1500 milliamps maximum
- Operates between 350 to 525 milliamps
- 100,000+ L70 life

LED Driver

- D – 2 wire forward phase .01% LED driver fade to off glow to on
- ED – 2 wire reverse phase 1% LED driver
- 0-10V – 3 wire 1% LED driver
- Absolute Light – Remote mount class 2 48V din rail .001% LED system
- 16-bit RMD DMX – 65,536 dimming steps fade to off glow to on

Optics

- TIR discrete injection molded polycarbonate precision LED optic
- 45-degree vertical cut off

Installation

- EMT Connector – Push Lock EMT Connector Installation

Certification

- UL Wet Listed – IP66

Warranty

- 5 Year = 100,000 hr. L70 life

New Construction and Retrofit

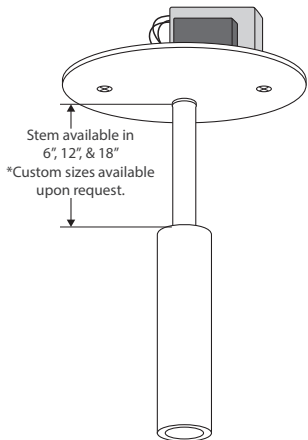

Luminosity Accessory

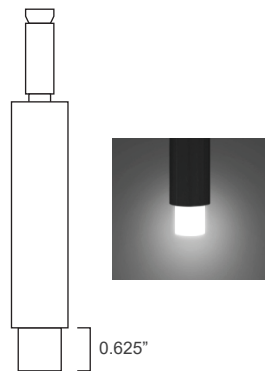

Optional Fixture Lengths (8", 12", & 18")

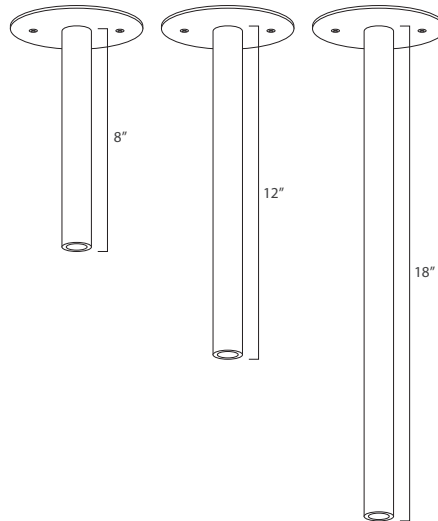

Remote Transformer (2" plate with fixture mounting holes)

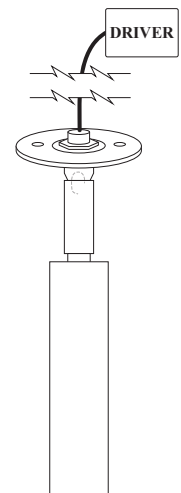

SMR1-601-PAR8-FIX

Fixed Mono Point

Project Name:		Type:	
Catalog Number:		Date:	

Wattage & Lumen Output	
300 Milliamps - 500 Lumens	
5W	ON/OFF 0-10V 1% Dimming ED
7W	MLV <1% Dimming
700 Milliamps	
10W	Red - Up to 150 Lumens Green - Up to 150 Lumens Blue - Up to 150 Lumens White - Up to 300 Lumens
525 Milliamps - 900 Lumens	
11W	ON/OFF 0-10V 1% Dimming ED
14W	MLV <1% Dimming

RGBW V2 Light Output Luminous Flux Clarté Lighting offers 100% of fixtures in optional RGBW3K or RGBW4K		
	700 mA RGBW3K	700 mA White 3K
Red	160	
Green	310	
Blue	46	
White	260	
Total	776	907

*RGBW Fixtures are designed to not operate with all 4 colors at 100% of light for more than 24hrs continuously and suggest operating 55% or less of all 4 colors ON to ensure optimum thermal life of the RGBW LED.

3 Step CREE XHP50(3) LED	
Kelvin-CRI	Multiplier
27K-80+ CRI	1
27K-90+ CRI	0.80
30K-80+ CRI	1
30K-90+ CRI	0.85
35K-80+ CRI	105
35K-90+ CRI	0.9
40K-80+ CRI	109
50K-80+ CRI	109
65K-80+ CRI	105
80+ = 84 CRI	
90+ = 94 CRI	

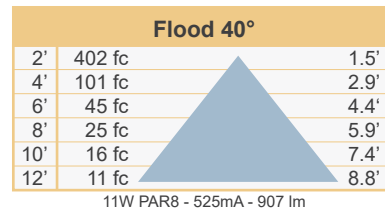
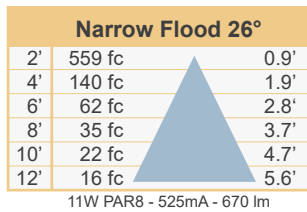

Zonal Flux and Percentages

Zone	%Luminaire
0-20	63
0-30	83.3
0-40	89.8
0-60	95.8
0-80	99.2
0-90	100
10-90	77.9
20-40	26.7
20-50	30.6
40-70	8
60-80	3.4
70-80	1.4
80-90	0.8

Zonal Flux and Percentages

Zone	%Luminaire
0-20	47.3
0-30	74.3
0-40	88.5
0-60	97.5
0-80	99.5
0-90	100
10-90	87.1
20-40	41.2
20-50	48.7
40-70	10.1
60-80	2
70-80	0.9
80-90	0.5

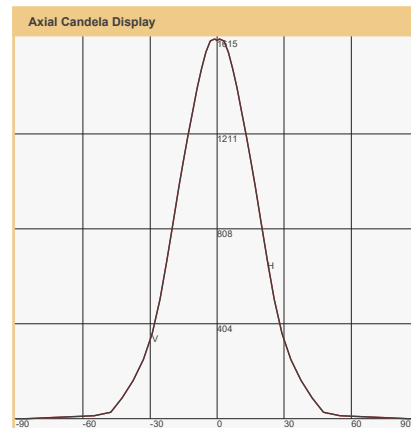
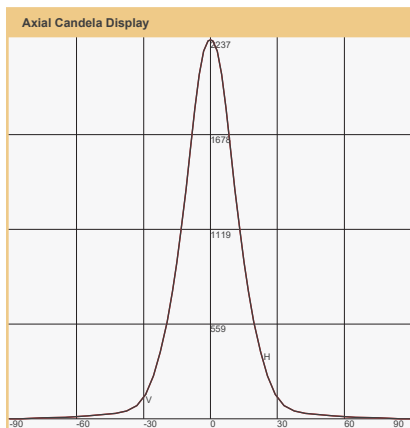

Project Name:		Type:	
Catalog Number:		Date:	

Clarté Lighting 3000K 80+ CRI Color Metrics

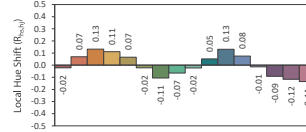
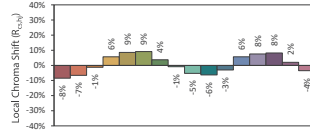
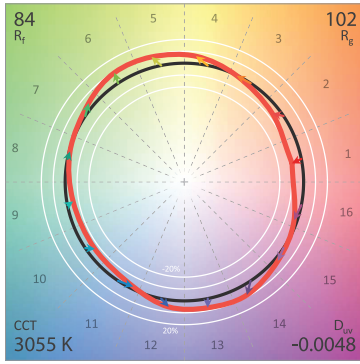

CIE 13.3-1995 (CRI)
R_a 86
R₉ 29

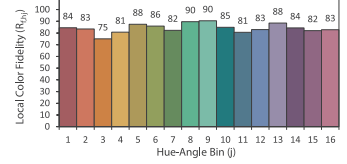
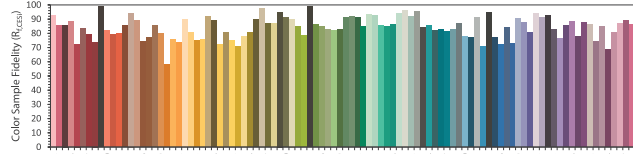

Clarté Lighting 3000K 90+ CRI Color Metrics

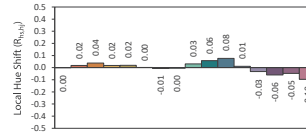
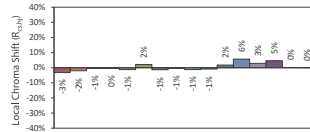
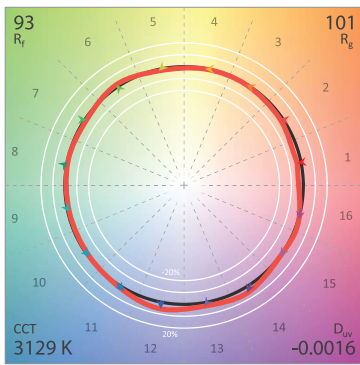

CIE 13.3-1995 (CRI)
R_a 95
R₉ 74

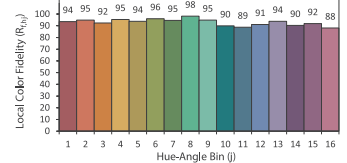
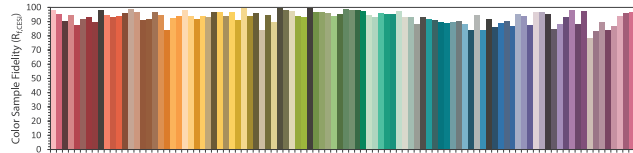

Clarté Lighting 3000K 90+ CRI Halogen Lens (H) Color Metrics

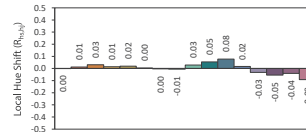
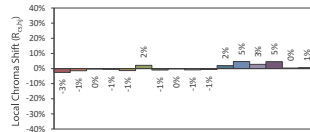
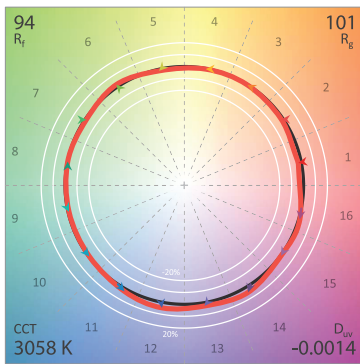

CIE 13.3-1995 (CRI)
R_a 96
R₉ 79

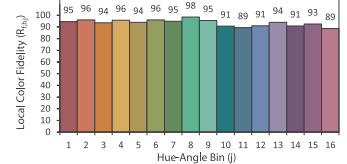
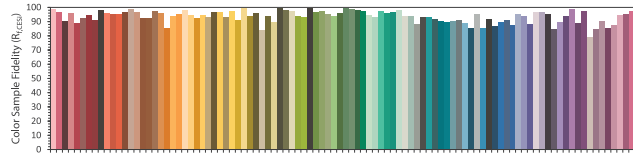

Clarté Lighting 3000K 90+ CRI Dimmed Halogen Lens (DH) Color Metrics

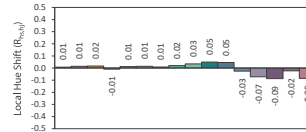
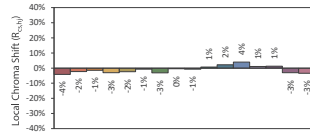
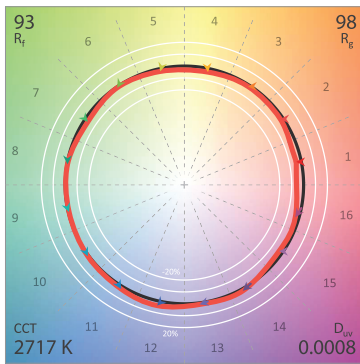

CIE 13.3-1995 (CRI)
R_a 95
R₉ 64

