

SMR1-601-PAR8-SRW

ADA Surface Half Round Wall

Project Name:		Type:	
Catalog Number:		Date:	

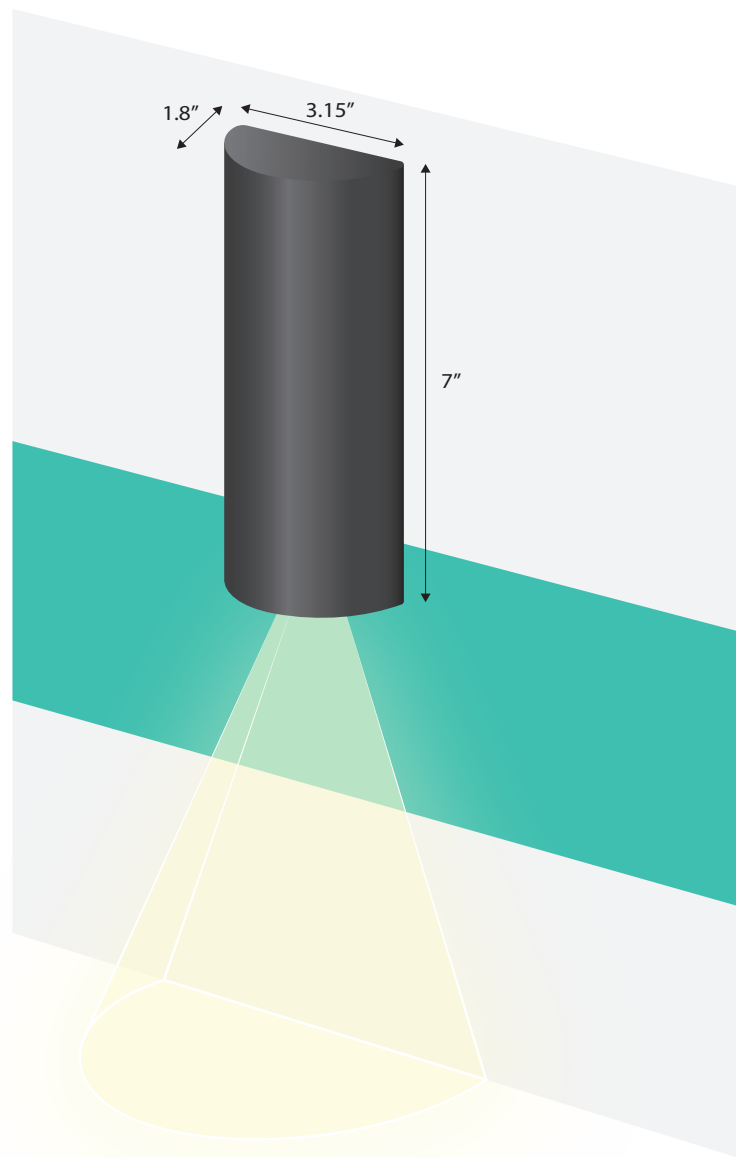

Key Features

- ADA Compliant = 1.625" depth
- Fixture Width = 2.8"
- 3/4" ID & 1" OD LED Optic
- 4 Beam Spreads – Spot (17°), Narrow Flood (26°) or Flood (40°), Luminosity (50° with Vertical Illumination)
- Class 2 = 12V, 24V or 48V
- Accepts Up to 3 Optical Accessories
- UL = Damp Listed & IP66

LED Source Details

- CREE XHP50 LED maximum rating = 1500 mA
- Operating Range = 350 mA to 700 mA
 - Operating 15% to 38% of Rated Value
 - Fixture Wattage Range = 5W to 14W
 - Fixture Delivered Lumens = 450 to 900 Lumens

Patent No.: US 10,208,928 B1

Last revised: 05/11/2026

SMR1-601-PAR8-SRW

ADA Surface Half Round Wall

Project Name:		Type:	
Catalog Number:		Date:	

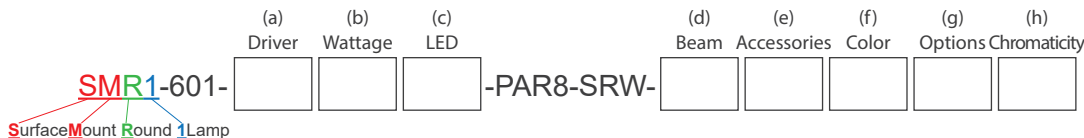

(a) Driver Options

- 12V AC = Must utilize a remote magnetic low voltage transformer
- 24V DC = Direct connection to existing 24V DC power supply
- 0-10V* = Remote mount 4 wire 0-10V LED driver single fixture
- 0-10V 4** = Remote mount 4 wire 0-10V driver for up to 4 fixtures
- DALI2 = .01% Digital Addressable Lighting Interface V2
- ABS = Absolute Light remote mount 48V din rail RGBW3K
- ABSX = DMX Absolute Light .001% RGBW dimming

*Remote single 0-10V LED driver up to 18' away 18ga and 50' away 12ga
 **Remote 0-10V LED driver operates up to 4 fixtures up to 18' away 18ga and 50' away 12ga

(b) Wattage Options

- 5W = 0-10V (350 milliamps), 450 lumens
- 7W = MLV (350 milliamps), 450 lumens
- 11W = 0-10V (700 milliamps), 900 lumens
- 14W = MLV (700 milliamps), 900 lumens







(c) LED Type Options

- X4LED = Cree XHP50 LED

(d) Beam Options

- SP = Spot 17° NFL = Narrow Flood 26°
- FL = Flood 40° LM = Luminosity Flood 50° Vertical Illumination with 5/8" glow extension

(e) Optical and Accessory Options

- LS = Lens Softener - +20% increase in beam width. Shields optical face visually. Softens edges of beam. 
- LSL = Linear Spread Lens - Horizontal or vertical beam elongation. 
- WFL = Wide Flood Lens - Wall washing increases the beam by 50% width with elimination of center beam. 
- LV = Louver - Hexcel louver eliminates all surface brightness. Creates stronger vertical cut off with -20% beam width. 
- CHL = Cross Hair Louver 
- H = Halogen - 150K warmer. 2700k to 2550K 
- DH = Dimmed Halogen - 300K warmer. 2700k to 2400K 

(f) Fixture Color Options

- BLK* = Black
 - WHT* = White
 - PWT* = Pewter
- Select Custom Color (Review Website for Over 3,300 Color Options)

*Zinc based powder coat paint for weatherization

(g) Options

- RMT = Remote Driver Other than MLV Step Down Transformer
- RMT14 = 14Watt 12V AC MLV Step Down Transformer
- RMT60 = 60Watt 12V AC MLV Step Down Transformer
- RMT150 = 150Watt 12V AC MLV Step Down Transformer
- RMT300 = 300Watt 12V AC MLV Step Down Transformer
- 120V = 120VAC 60Hz (Standard)
- 230V = 230VAC 50Hz
- 277V = 277VAC 60Hz
- EMG = Remote 90min Emergency Back-Up
- 80+ = CRI over 80
- 90+ = CRI over 90

(h) Color Temperature Options

White LED

- 22K* = 2200 Kelvin (candlelight color)
- 27K = 2700 Kelvin (incandescent color)
- 30K = 3000 Kelvin (halogen color)
- 35K = 3500 Kelvin (warm incandescent)
- 40K = 4000 Kelvin (cool incandescent)
- 50K = 5000 Kelvin (day white)
- 65K = 6500 Kelvin (12 noon sunlight)

Colored/Themed LED

- UV365** = 365 NM UV black light
- UV390** = 390 NM UV black light
- Blue* = 465 - 485 NM wavelength
- Green* = 520 - 535 NM wavelength
- Amber* = 585 - 595NM wavelength
- Red* = 620 - 630 NM wavelength
- RGBW3K*** = Red, Green, Blue, White
- RGBW4K*** = Red, Green, Blue, White

available soon

*1050 mA or less

**700 mA or less
 **Must utilize DMX fixture option

SMR1-601-PAR8-SRW

ADA Surface Half Round Wall

Project Name:		Type:	
Catalog Number:		Date:	

Product Details

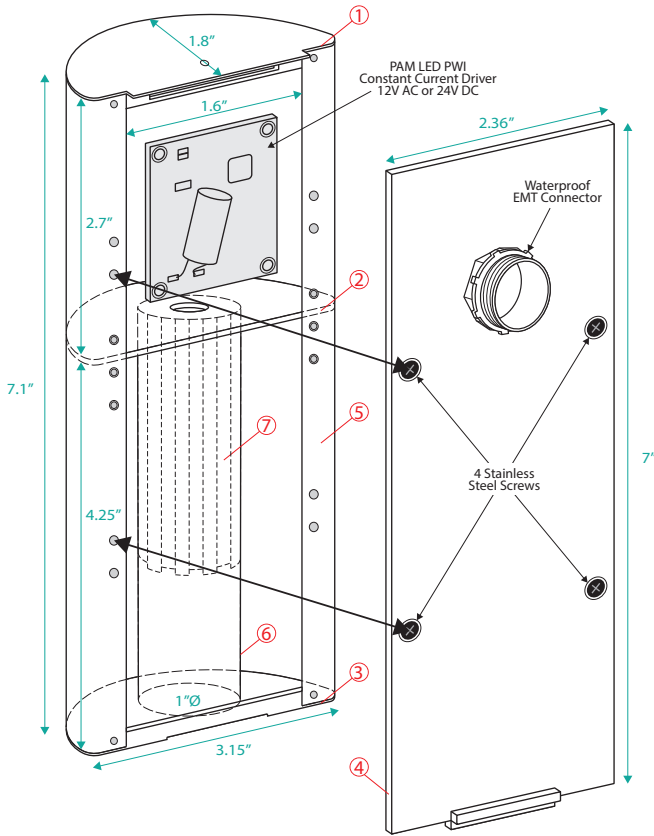

3D Printed ASA Parts

*ASA Plastic (Acrylonitrile Styrene Acrylate) – Non-yellowing, UV stabilized, and optimized for exterior applications. Higher thermal resistance than ABS

- 1 - Top Cap
- 2 - Housing Inner Mounting Shelf
- 3 - Bottom Cap
- 4 - Back Plate

Aluminum

- 5 - Formed Rounded Aluminum Front Housing
- 6 - Extruded Threaded 1" PAR8 Scale Optic Outer Sleeve
- 7 - PAR8 Scale Optic Extruded Heat Sync

Electrical – Class 2 = 12V, 24V or 48V

- 12V AC = Must utilize a remote magnetic low voltage transformer
- 24V DC = Direct connection to existing 24V DC power supply
- 0-10V = Remote mount 4 wire 0-10V LED driver single fixture
- 0-10V 4 = Remote mount 4 wire 0-10V driver for up to 4 fixtures
- ABS = Absolute Light remote mount 48V din rail RGBW3K

LED

- CREE XHP50
- 1500 milliamps maximum
- Operates between 350 to 700 milliamps
- 100,000+ L70 life

LED Driver

- 12V AC = Must utilize a remote magnetic low voltage transformer
- 24V DC = Direct connection to existing 24V DC power supply
- 0-10V = Remote mount 4 wire 0-10V LED driver single fixture
- 0-10V 4 = Remote mount 4 wire 0-10V driver for up to 4 fixtures
- ABS = Absolute Light remote mount 48V din rail RGBW3K

Optics

- TIR discrete injection molded polycarbonate precision LED optic
- 45-degree vertical cut off

Installation

- EMT Connector – Push Lock EMT Connector Installation

Certification

- CE – In compliance with EU regulations
- UL – Damp Listed
- UL – IP66

Warranty

- 5 Year = 100,000 hr. L70 life

Exterior Rail Application

Luminosity Accessory

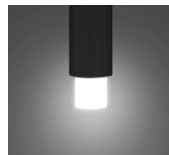
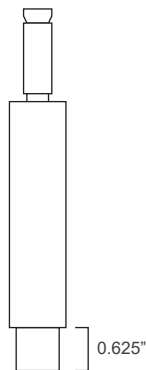
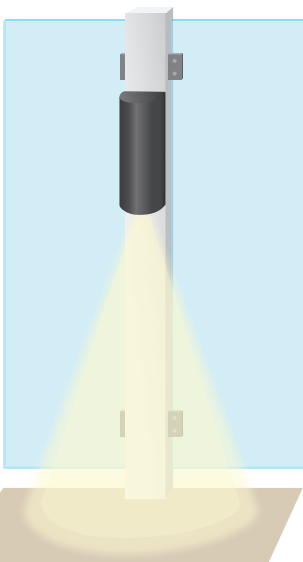

SMR1-601-PAR8-SRW

ADA Surface Half Round Wall

Project Name:		Type:	
Catalog Number:		Date:	

Wattage & Lumen Output			
300 Milliamps - 500 Lumens		700 Milliamps	
5W	ON/OFF	10W	Red - Up to 150 Lumens
	0-10V 1% Dimming		Green - Up to 150 Lumens
	ED		Blue - Up to 150 Lumens
7W	MLV <1% Dimming		White - Up to 300 Lumens
525 Milliamps - 900 Lumens		700 Milliamps - 1150 Lumens	
11W	ON/OFF	15W	ON/OFF
	0-10V 1% Dimming		0-10V 1% Dimming
	ED		ED
14W	MLV <1% Dimming	14W	MLV <1% Dimming
			DMX

3 Step CREE XPL2 LED	
Kelvin-CRI	Multiplier
27K-80+ CRI	1
27K-90+ CRI	0.80
30K-80+ CRI	1
30K-90+ CRI	0.85
35K-80+ CRI	105
35K-90+ CRI	0.9
40K-80+ CRI	109
50K-80+ CRI	109
65K-80+ CRI	105
80+ = 84 CRI	
90+ = 94 CRI	

RGBW V2 Light Output Luminous Flux		
Clarté Lighting offers 100% of fixtures in optional RGBW3K or RGBW4K		
	700 mA RGBW3K	700 mA White 3K
Red	160	
Green	310	
Blue	46	
White	260	
Total	776	907

*RGBW Fixtures are designed to not operate with all 4 colors at 100% of light for more than 24hrs continuously and suggest operating 55% or less of all 4 colors ON to ensure optimum thermal life of the RGBW LED.

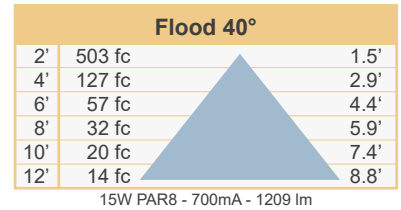
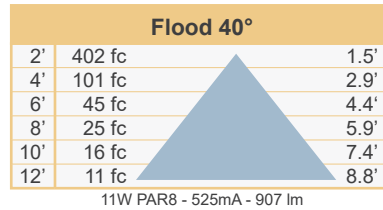
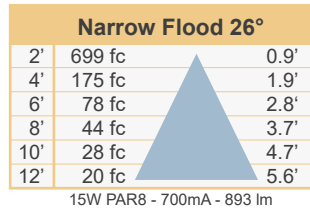
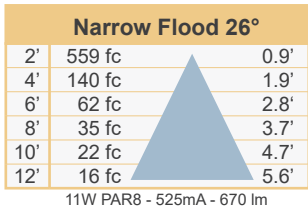

Zonal Flux and Percentages

Zone	%Luminaire
0-20	63
0-30	83.3
0-40	89.8
0-60	95.8
0-80	99.2
0-90	100
10-90	77.9
20-40	26.7
20-50	30.6
40-70	8
60-80	3.4
70-80	1.4
80-90	0.8

Zonal Flux and Percentages

Zone	%Luminaire
0-20	47.3
0-30	74.3
0-40	88.5
0-60	97.5
0-80	99.5
0-90	100
10-90	87.1
20-40	41.2
20-50	48.7
40-70	10.1
60-80	2
70-80	0.9
80-90	0.5

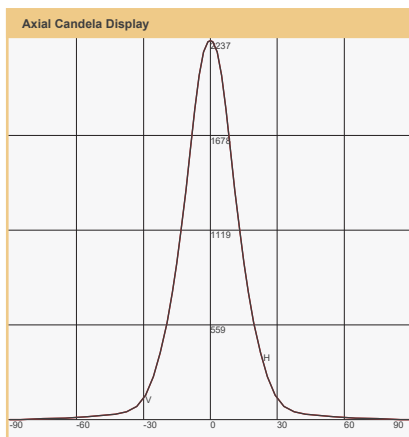

Maximum Candela = 2237 Located At Horizontal Angle = 0, Vertical Angle = 0
 H - Horizontal Axial Candela
 V - Vertical Axial Candela

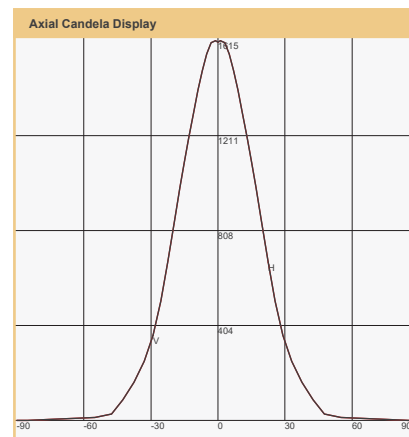

Maximum Candela = 1615 Located At Horizontal Angle = 0, Vertical Angle = 0
 H - Horizontal Axial Candela
 V - Vertical Axial Candela

Project Name:		Type:	
Catalog Number:		Date:	

Clarté Lighting 3000K 80+ CRI Color Metrics

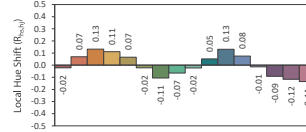
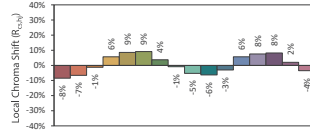
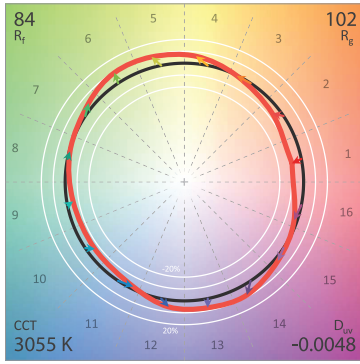

CIE 13.3-1995 (CRI)
 R_a 86
 R_g 29

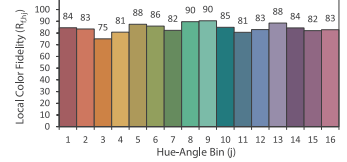
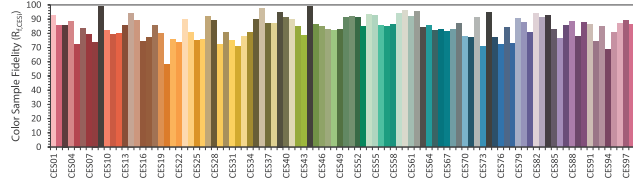

Clarté Lighting 3000K 90+ CRI Color Metrics

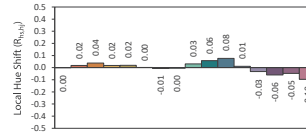
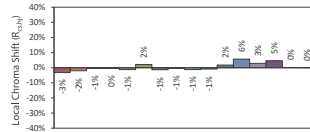
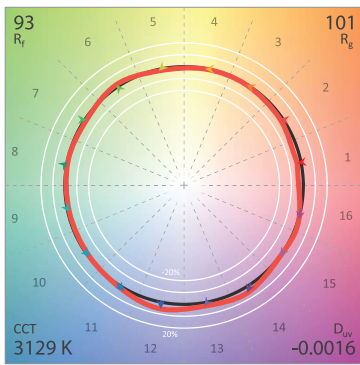

CIE 13.3-1995 (CRI)
 R_a 95
 R_g 74

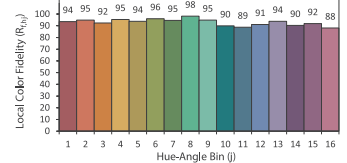
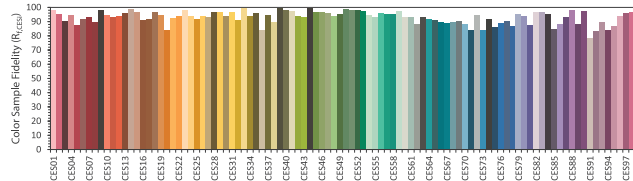

Clarté Lighting 3000K 90+ CRI Halogen Lens (H) Color Metrics

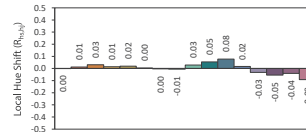
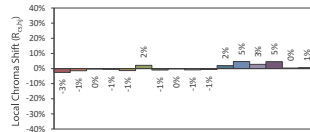
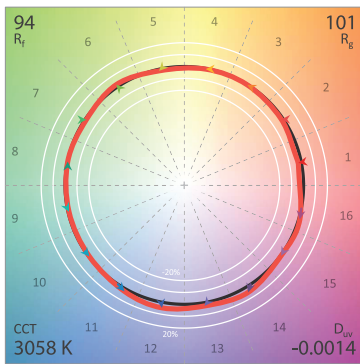

CIE 13.3-1995 (CRI)
 R_a 96
 R_g 79

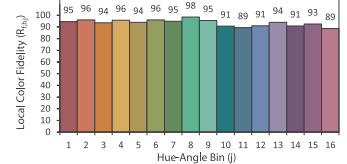
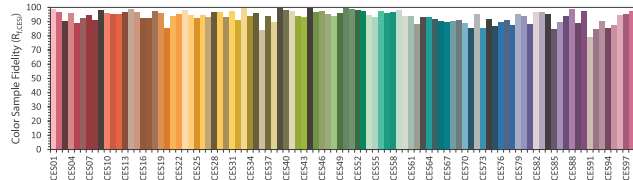

Clarté Lighting 3000K 90+ CRI Dimmed Halogen Lens (DH) Color Metrics

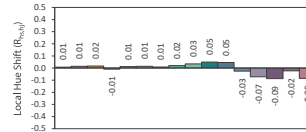
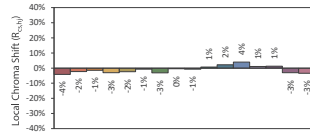
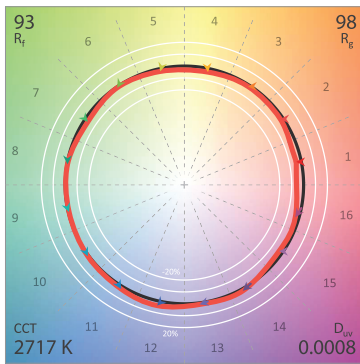

CIE 13.3-1995 (CRI)
 R_a 95
 R_g 64

