

Project Name:		Type:	
Catalog Number:		Date:	

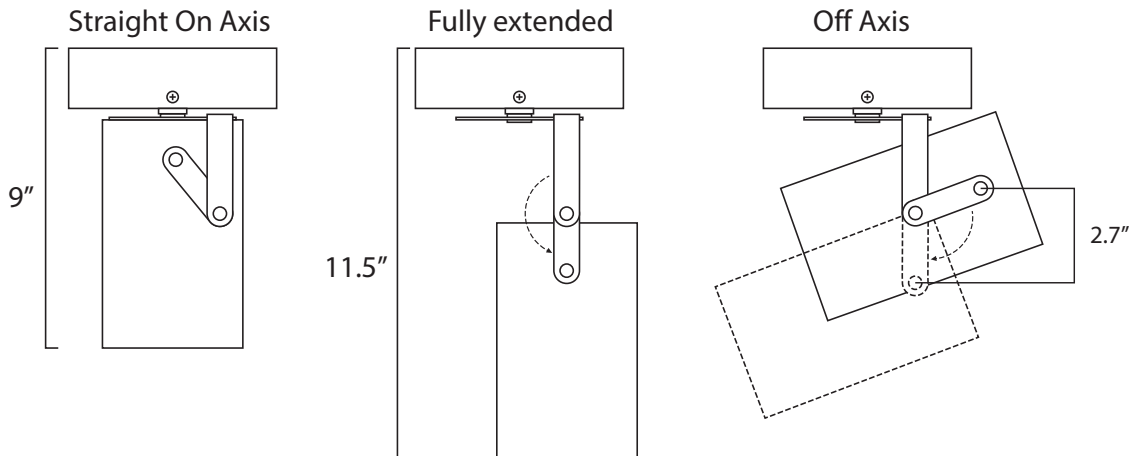
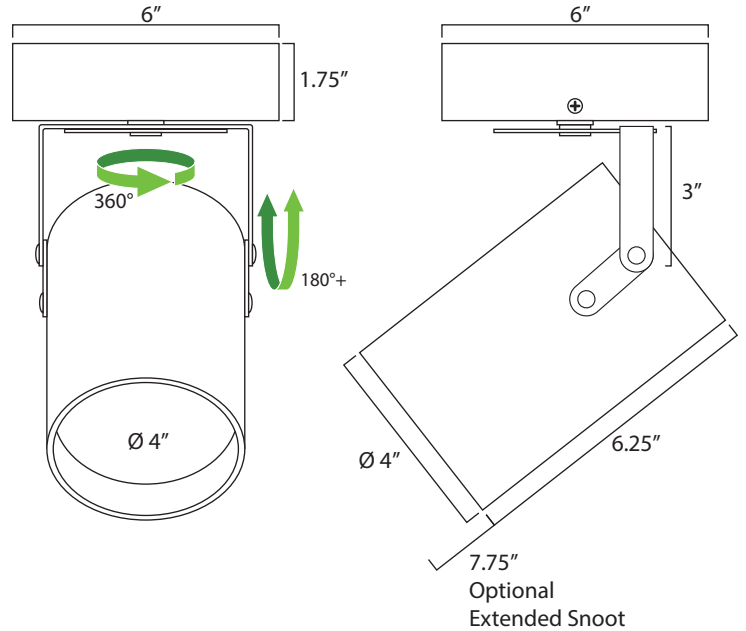

Key Features

- 4" OD
- Up to 4 accessories
- Remote transformer option
- Over 10,000+ fixture custom color finish options
- 100,000+ hr L70 life
- See Page 3 for additional options

LED Source Details

- CREE XML2 LED maximum rating 3,000 mA
- Fixture operating milliamps = 700 mA – 1,400 mA
 - Operating 23% to 47% of rated value
 - Fixture Delivered Lumens = 3500 lumens

Last revised: 05/04/2026

Project Name:		Type:	
Catalog Number:		Date:	

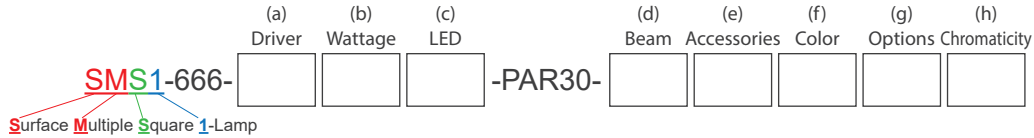

(a) Driver Options

- E = ON/OFF (Electronic)
- D = MLV 1% Dimming (2 wire)
- DC12V = .01% PWM DC dimming (2 wire)
- DC24V = .01% PWM DC dimming (2 wire)
- ED = Electronic Reverse Phase Dimming 1% (2 wire)
- 0-10V1 = 0-10V 1% Dimming (4 wire)
- RDM DMX = 16 Bit, 4 Channel (2 wire with CAT5)

(b) Wattage Options

- 24W (700 milliamps/1600 lumens) = ON/OFF, 0-10V 1%
- 27W (700 milliamps/1600 lumens) = MLV <1% Dimming
- 36W (1050 milliamps/2400 lumens) = ON/OFF, 0-10V 1%
- 42W (1050 milliamps/2400 lumens) = MLV <1% Dimming
- 48W (600 milliamps/2000 lumens) = RDM DMX RGBW
- 51W (1200 milliamps/3000 lumens) = MLV <1% Dimming
- 55W (1400 milliamps /3500 lumens) = ON/OFF, 0-10V 1% or RDM DMX







(c) Lamp Type Options

- XLED = Cree XPL2 LED @ All Wattages

(d) Beam Options

- NSP = Narrow Spot NFL = Narrow Flood
- SP = Spot FL = Flood

(e) Optical and Accessory Options

- LS = Lens Softener - +20% increase in beam width. Shields optical face visually. Softens edges of beam. 
- LSL = Linear Spread Lens - Horizontal or vertical beam elongation. 
- WFL = Wide Flood Lens - Wall washing increases the beam by 50% width with elimination of center beam. 
- LV = Louver - Hexcel louver eliminates all surface brightness. Creates stronger vertical cut off with -20% beam width. 
- CHL = Cross Hiar Louver 
- H = Halogen - 150K warmer. 2700k to 2550K 
- DH = Dimmed Halogen - 300K warmer. 2700k to 2400K 

(f) Fixture Color Options

- BLK = Black
- WHT = White
- PWT = Pewter
- Select Custom Color (Review Website for Over 3,300 Color Options)

(g) Options

- 120V = 120VAC 60Hz (Standard)
- 230V = 230VAC 50Hz
- 277V = 277VAC 60Hz
- SCM1 = Side Conduit Mount In (3/4" In)
- SCM2 = Side Conduit Mount In and Out (3/4" In and Out)
- 80+ = CRI over 80
- 90+ = CRI over 90
- BD = Barn Doors
- ES = Extended Snoot

(h) Color Temperature Options

- | | |
|--|--------------------------------------|
| White LED | Colored/Themed LED |
| 22K* = 2200 Kelvin (candlelight color) | UV275** = 275 NM UV virus sterilizer |
| 27K = 2700 Kelvin (incandescent color) | UV365*** = 365 NM UV black light |
| 30K = 3000 Kelvin (halogen color) | UV390*** = 390 NM UV black light |
| 35K = 3500 Kelvin (warm incandescent) | Blue*** = 465 - 485 NM wavelength |
| 40K = 4000 Kelvin (cool incandescent) | Green*** = 520 - 535 NM wavelength |
| 50K = 5000 Kelvin (day white) | Amber*** = 585 - 595NM wavelength |
| 65K = 6500 Kelvin (12 noon sunlight) | Red*** = 620 - 630 NM wavelength |
| | RGBW3K**** = Red, Green, Blue, White |
| | RGBW4K**** = Red, Green, Blue, White |

*1050 mA or less

**500 mA

***700 mA

****Must utilize DMX @ 700 mA

SMS1-666-PAR30

Surface Low Profile

Project Name:		Type:	
Catalog Number:		Date:	

Hinged Barn Doors

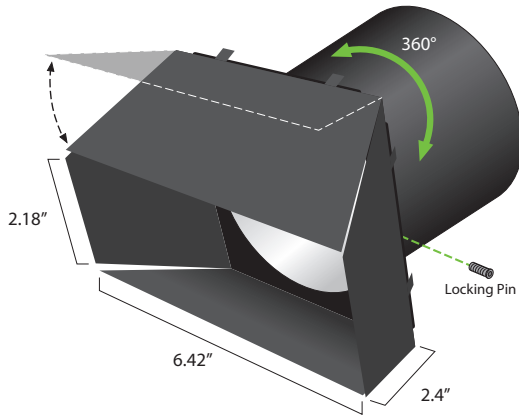
**Housing**

- 100% aluminum construction

Electrical

- Optional - 12V AC remote class 2
- 100V, 120V, 230V, 277V or 347V

LED

- 3,000mA maximum rated CREE XPL2 LED
- Operates between 450 to 1200mA
- 15% to 40% of rated mA

LED Driver

- D – 2 wire forward phase .01% LED driver fade to off glow to on
- ED – 2 wire reverse phase 1% LED driver
- DC – 12V or 24V

Optics

- TIR discrete injection molded polycarbonate precision LED optic
- 45-degree vertical cut off

Installation Details

- J-Box with 2-Part Fixture Housing
- Back Box with LED Driver - Mount to J-Box with Reducer Ring
- Optical Assembly - Slide on Over Back Box Affixed by 2 Side-Set Screws

Certification

- UL Damp Listed – IP 52

Warranty

- 5 Year – ED, 0-10V, DMX and colored LED fixtures
- 7 Year – D and White LED fixtures

Installation Details

- Back Box with LED Driver - Mount to J-Box with Reducer Ring
- Optical Assembly - Slide on Over Back Box Affixed by 2 Side-Set Screws

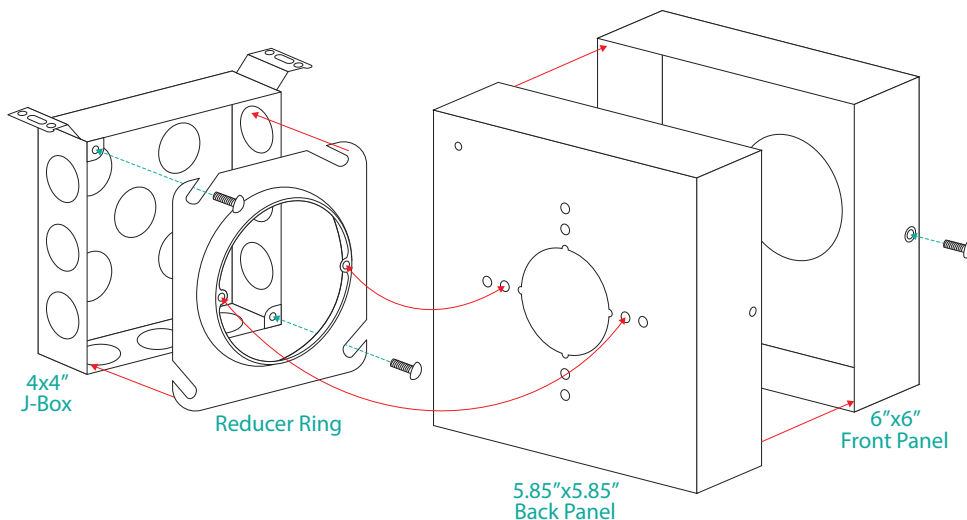

Project Name:		Type:	
Catalog Number:		Date:	

Wattage & Lumen Output

700 Milliamps - 1800 Lumens
22W

1000 Milliamps - 2500 Lumens
33W

1200 Milliamps - 3100 Lumens
42W

1400 Milliamps - 3400 Lumens
46W

1600 Milliamps - 3900 Lumens
55W

3 Step CREE XPL2 LED

Kelvin-CRI	Multiplier
27K-80+ CRI	1
27K-90+ CRI	0.80
30K-80+ CRI	1
30K-90+ CRI	0.85
35K-80+ CRI	105
35K-90+ CRI	0.9
40K-80+ CRI	109
50K-80+ CRI	109
65K-80+ CRI	105

80+ = 84 CRI
90+ = 94 CRI

Narrow Spot 12°

2'	11,097 fc	0.4'
4'	2,774 fc	0.9'
6'	1,233 fc	1.3'
8'	694 fc	1.7'
10'	444 fc	2.1'
12'	308 fc	2.6'

55W PAR30 - 3,372 lm

Intensity Summary (cd)

Gamma	All Planes	Flux (lm)
0	44389	
5	27240	1963
10	9044	
15	2798	872
20	854	
25	440	214
30	285	
35	211	135
40	172	
45	133	105
50	102	
55	57	56
60	45	
65	29	25
70	3	
75	1	1
80	1	
85	0	0
90	0	

Zonal Flux and Percentages

Zone	Flux (lm)	%Luminaire
0-30	3049	90.4
0-40	3784	94.4
0-60	3345	99.2
0-90	3372	100.0
40-90	188	5.6
60-90	27	0.8
90-180	0	0.0
0-180	3372	100.0

Narrow Flood 22°

2'	x fc	x.x'
4'	x fc	x.x'
6'	x fc	x.x'
8'	x fc	x.x'
10'	x fc	x.x'
12'	x fc	x.x'

55W PAR30 - 3,841 lm

Intensity Summary (cd)

Gamma	All Planes	Flux (lm)
0	19074	
5	16233	1332
10	9848	
15	5190	1461
20	2626	
25	1289	620
30	632	
35	329	220
40	211	
45	146	114
50	98	
55	57	55
60	42	
65	27	26
70	14	
75	9	10
80	6	
85	2	3
90	0	

Zonal Flux and Percentages

Zone	Flux (lm)	%Luminaire
0-30	3413	88.8
0-40	3633	94.6
0-60	3802	99.0
0-90	3840	100.0
40-90	208	5.4
60-90	39	1.0
90-180	0	0.0
0-180	3841	100.0

Flood

2'	fc	'
4'	fc	'
6'	fc	'
8'	fc	'
10'	fc	'
12'	fc	'

55W PAR30 - 2,919 lm

Intensity Summary (cd)

Gamma	All Planes	Flux (lm)
0	6451	
5	5949	529
10	4754	
15	3424	944
20	2326	
25	1552	720
30	1033	
35	639	405
40	368	
45	227	181
50	145	
55	88	83
60	58	
65	39	39
70	21	
75	14	15
80	9	
85	4	4
90	0	

Zonal Flux and Percentages

Zone	Flux (lm)	%Luminaire
0-30	2193	75.1
0-40	2598	89.0
0-60	2862	98.0
0-90	2919	100.0
40-90	321	11.0
60-90	58	2.0
90-180	0	0.0
0-180	2919	100.0

RGBW V2 Light Output Luminous Flux Clarté Lighting offers 100% of fixtures in optional RGBW3K or RGBW4K

Line Voltage	ABS Light	700 mA	700 mA
600 mA	700 mA	RGBW3K	White 3K
Red	1296	1440	
Green	2511	2790	
Blue	372	414	
White	2106	2340	
Total	6285	6984	2533

*RGBW Fixtures are designed to not operate with all 4 colors at 100% of light for more than 24hrs continuously and suggest operating 55% or less of all 4 colors ON to ensure optimum thermal life of the RGBW LED.

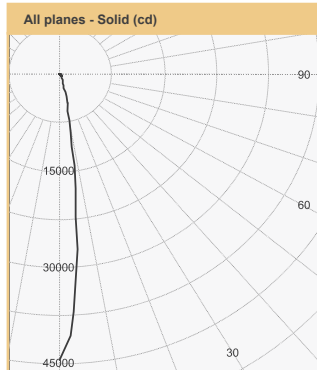

(Rotational Symmetry)

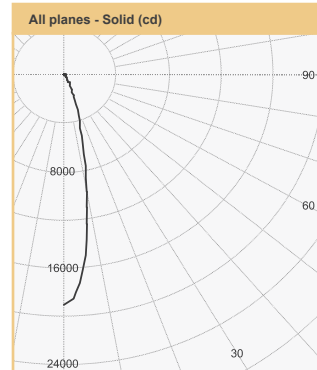

(Rotational Symmetry)

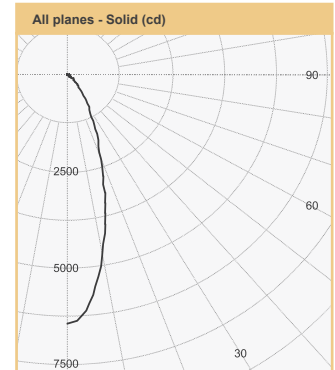

(Rotational Symmetry)

Project Name:		Type:	
Catalog Number:		Date:	

Clarté Lighting 3000K 80+ CRI Color Metrics

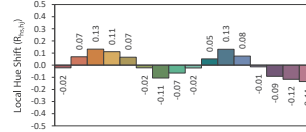
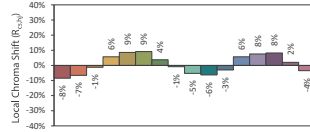
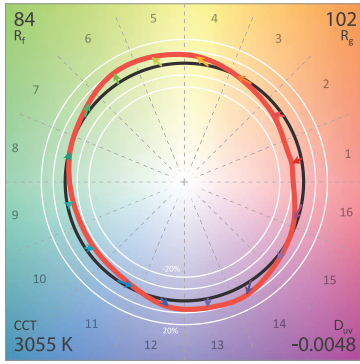

CIE 13.3-1995 (CRI)
 R_a 86
 R_g 29

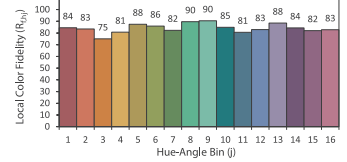
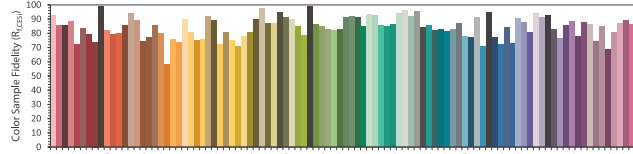

Clarté Lighting 3000K 90+ CRI Color Metrics

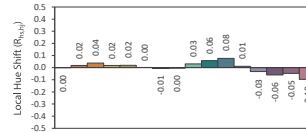
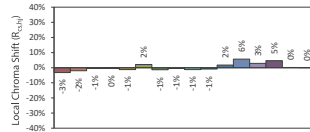
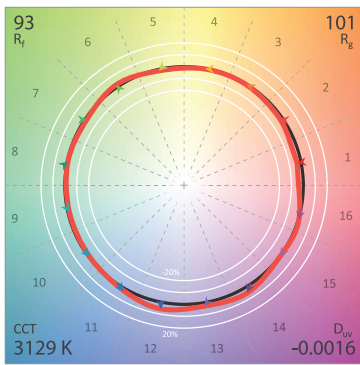

CIE 13.3-1995 (CRI)
 R_a 95
 R_g 74

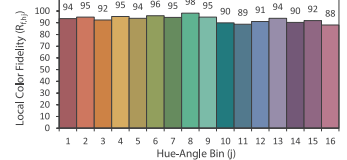
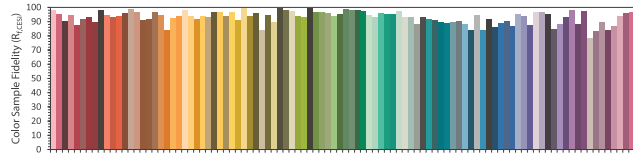

Clarté Lighting 3000K 90+ CRI Halogen Lens (H) Color Metrics

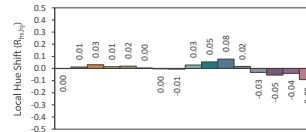
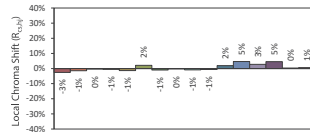
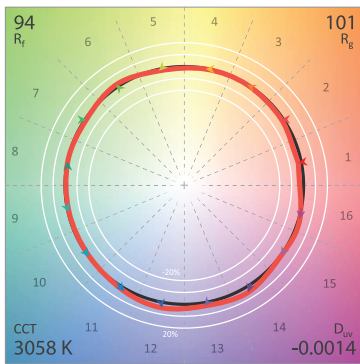

CIE 13.3-1995 (CRI)
 R_a 96
 R_g 79

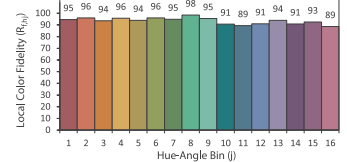
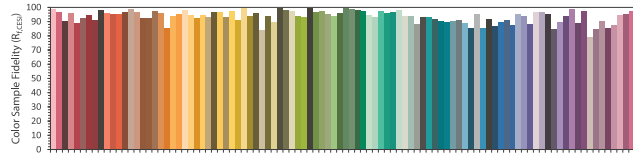

Clarté Lighting 3000K 90+ CRI Dimmed Halogen Lens (DH) Color Metrics

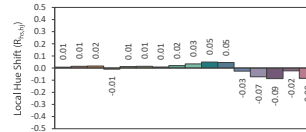
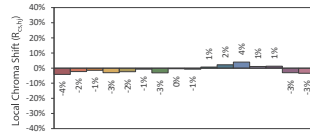
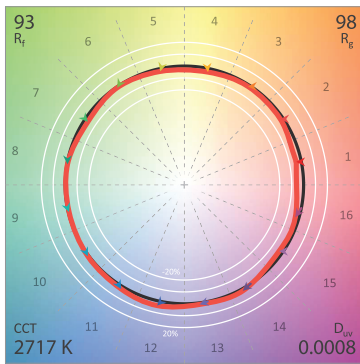

CIE 13.3-1995 (CRI)
 R_a 95
 R_g 64

