

# SMS3-668-PAR38

3-Lamp Surface Low Profile

Project Name:		Type:	
Catalog Number:		Date:	

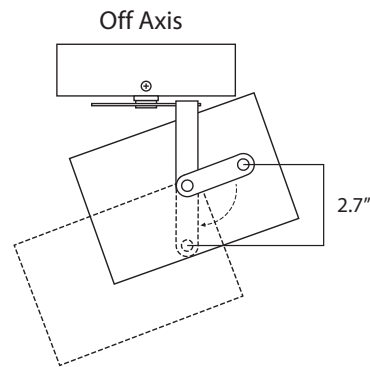
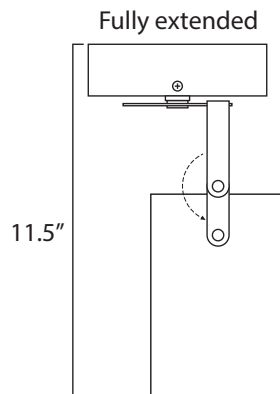
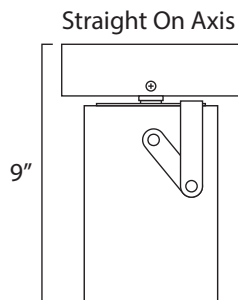
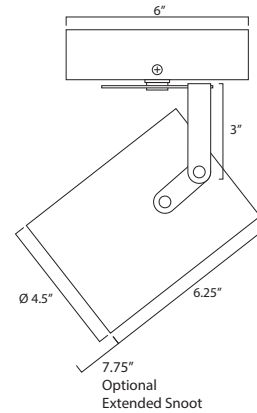
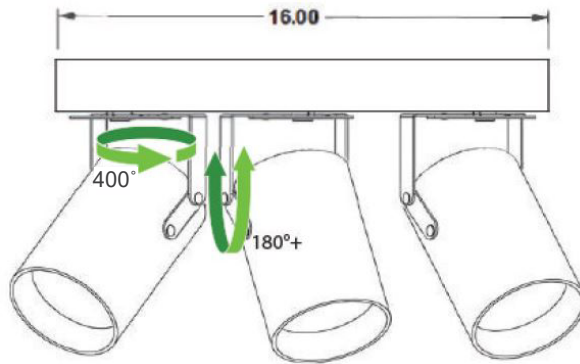

### Key Features

- 4.5" OD
- Up to 4 accessories
- Remote transformer option
- Over 10,000+ fixture custom color finish options
- 100,000+ hr L70 life

### LED Source Details

- CREE XPL2 LED maximum rating 3,000 mA
- Fixture operating milliamps = 1,500 mA
  - Fixture Wattage Range = 64W to 68W
  - Fixture Delivered Lumens = 4,500 lumens

Patent Pending

Last revised: 05/04/2026

# SMS3-668-PAR38

3-Lamp Surface Low Profile

Project Name:		Type:	
Catalog Number:		Date:	

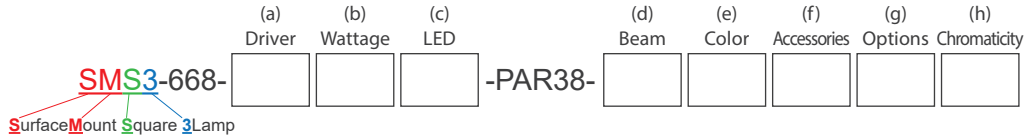

**(a) Driver Options**

E	= ON/OFF (Electronic)
D	= MLV 1% Dimming (2 wire)
0-10V1	= 0-10V 1% Dimming (4 wire)
RDM DMX	= 8 Bit or 16 Bit, 4 Channel (2 wire with CAT5)

**(b) Wattage Options**

64W	= 1500 milliamps/4500 lumens, ON/OFF, 0-10V or RDM DMX
68W	= 1200 milliamps/3600 lumens, MLV
72W	= 600 milliamps/3000 lumens, RDM DMX RGBW

**(c) Lamp Type Options**

XLED	= Cree XPL2 LED @ All Wattages
------	--------------------------------

**(d) Beam Options**

NSP	= Narrow Spot	NFL	= Narrow Flood
SP	= Spot	FL	= Flood

**(e) Fixture Color Options**

BLK	= Black
WHT	= White
PWT	= Pewter

Select Custom Color (Review Website for Over 3,300 Color Options)

**(f) Optical and Accessory Options**

LS	= Lens Softener - +20% increase in beam width. Shields optical face visually. Softens edges of beam.	
LSL	= Linear Spread Lens - Horizontal or vertical beam elongation.	
WFL	= Wide Flood Lens - Wall washing increases the beam by 50% width with elimination of center beam.	
LV	= Louver - Small black hexcel louver eliminates all surface brightness. Creates stronger vertical cut off with -20% beam width.	
CHL	= Cross Hiar Louver	
H	= Halogen - 150K warmer. 2700k to 2550K	
DH	= Dimmed Halogen - 300K warmer. 2700k to 2400K	

**(g) Options**

80+	= CRI over 80
90+	= CRI over 90
ES	= Extended Snoot

**(h) Color Temperature Options**

White LED	Colored/Themed LED
22K* = 2200 Kelvin (candlelight color)	UV365** = 365 NM UV black light
27K = 2700 Kelvin (incandescent color)	UV390** = 390 NM UV black light
30K = 3000 Kelvin (halogen color)	Blue** = 465 - 485 NM wavelength
35K = 3500 Kelvin (warm incandescent)	Green** = 520 - 535 NM wavelength
40K = 4000 Kelvin (cool incandescent)	Amber** = 585 - 595NM wavelength
50K = 5000 Kelvin (day white)	Red** = 620 - 630 NM wavelength
65K = 6500 Kelvin (12 noon sunlight)	RGBW3K*** = Red, Green, Blue, White
	RGBW4K*** = Red, Green, Blue, White

\*1050 mA or less      \*\*700 mA  
 \*\*\*Must utilize DMX @ 600 mA

**SMS3-668-PAR38**

3-Lamp Surface Low Profile

Project Name:		Type:	
Catalog Number:		Date:	

## Hinged Barn Doors

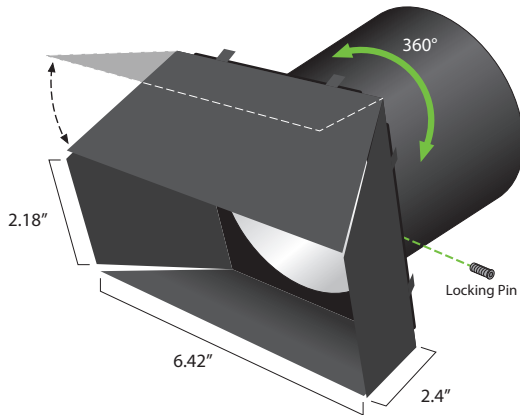
**Housing**

- 100% aluminum construction

**Electrical**

- Optional - 12V AC remote class 2
- 100V, 120V, 230V, 277V or 347V

**LED**

- 3,000mA maximum rated CREE XPL2 LED
- Operates between 450 to 1200mA
- 15% to 40% of rated mA

**LED Driver**

- D – 2 wire forward phase .01% LED driver fade to off glow to on
- ED – 2 wire reverse phase 1% LED driver
- DC – 12V or 24V

**Optics**

- TIR discrete injection molded polycarbonate precision LED optic
- 45-degree vertical cut off

**Installation**

- IPS Nipple - Unistrut (Not provided)

**Certification**

- UL Damp Listed – IP 52

**Warranty**

- 5 Year – ED, 0-10V, DMX and colored LED fixtures
- 7 Year – D and White LED fixtures

**Installation Details**

- Back Box with LED Driver - Mount to J-Box with Reducer Ring
- Optical Assembly - Slide on Over Back Box Affixed by 2 Side-Set Screws

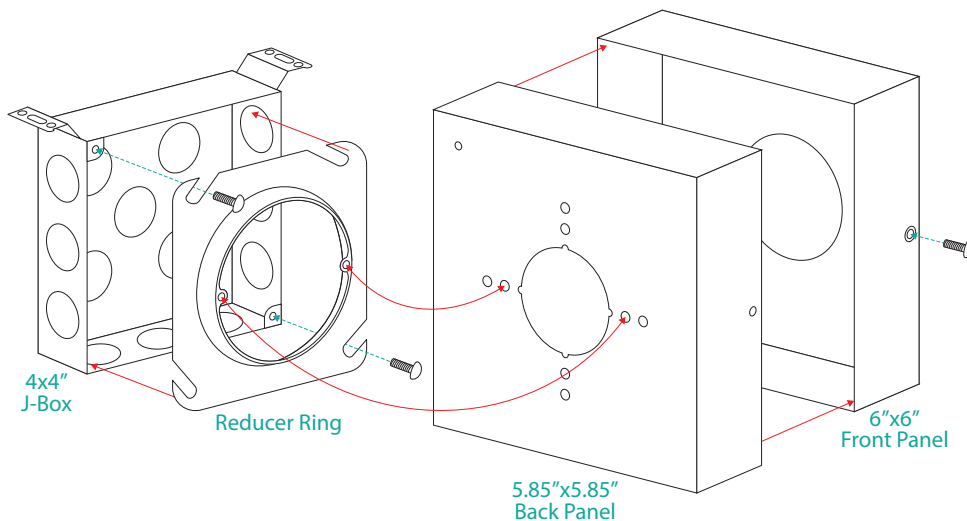

# SMS3-668-PAR38

## 3-Lamp Surface Low Profile

Project Name:		Type:	
Catalog Number:		Date:	

### Wattage & Lumen Output

<b>1400 Milliamps - 5000 Lumens</b>	
68W	ON/OFF
	0-10V 1% Dimming
	DMX Dimming

### 3 Step CREE XPL2 LED

Kelvin-CRI	Multiplier
27K-80+ CRI	1
27K-90+ CRI	0.80
30K-80+ CRI	1
30K-90+ CRI	0.85
35K-80+ CRI	105
35K-90+ CRI	0.9
40K-80+ CRI	109
50K-80+ CRI	109
65K-80+ CRI	105
80+ = 84 CRI	
90+ = 94 CRI	

### RGBW V2 Light Output Luminous Flux Clarté Lighting offers 100% of fixtures in optional RGBW3K or RGBW4K

	Line Voltage	ABS Light	
	600 mA RGBW3K	700 mA RGBW3K	700 mA White 3K
Red	1728	1920	
Green	3348	3720	
Blue	497	552	
White	2808	3120	
<b>Total</b>	<b>8381</b>	<b>9312</b>	<b>3377</b>

\*RGBW Fixtures are designed to not operate with all 4 colors at 100% of light for more than 24hrs continuously and suggest operating 55% or less of all 4 colors ON to ensure optimum thermal life of the RGBW LED.

### Narrow Flood 21°

2'	5,157 fc	0.7'
4'	1,289 fc	1.5'
6'	573 fc	2.2'
8'	322 fc	3.0'
10'	206 fc	3.7'
12'	143 fc	4.4'

67W PAR38 - 4,266 lm

### Zonal Flux and Percentages

Zone	Flux (lm)	%Luminaire
0-30	3369	79.0
0-40	3739	87.7
0-60	4197	98.4
0-90	4266	100.0
40-90	527	12.3
60-90	69	1.6
90-180	0	0.0
0-180	4266	100.0

### All planes - Solid (cd)

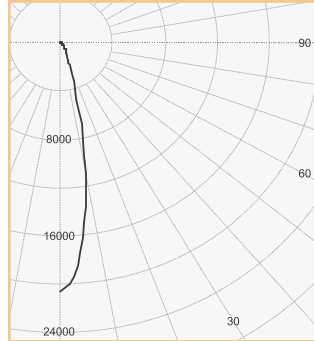

### Intensity Summary (cd)

Gamma	All Planes	Flux (lm)
0	20628	
5	17468	1451
10	10916	
15	4848	1396
20	1966	
25	1066	522
30	764	
35	582	370
40	476	
45	381	295
50	291	
55	177	163
60	103	
65	73	65
70	14	
75	3	4
80	1	
85	0	1
90	0	

Project Name:		Type:	
Catalog Number:		Date:	

Clarté Lighting 3000K 80+ CRI Color Metrics

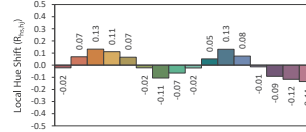
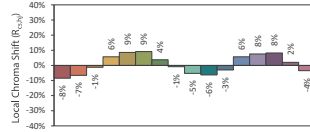
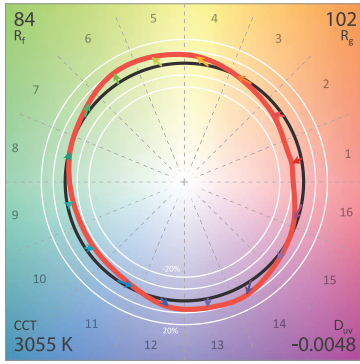

CIE 13.3-1995 (CRI)  
 $R_a$  86  
 $R_g$  29

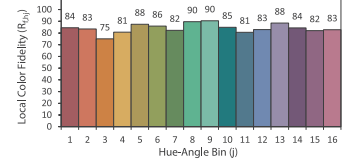
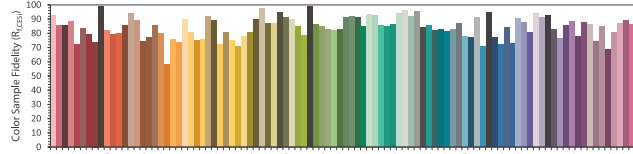

Clarté Lighting 3000K 90+ CRI Color Metrics

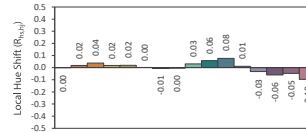
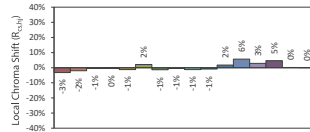
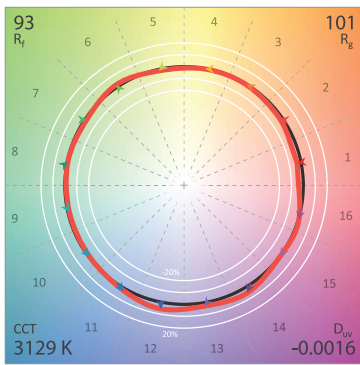

CIE 13.3-1995 (CRI)  
 $R_a$  95  
 $R_g$  74

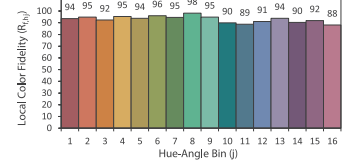
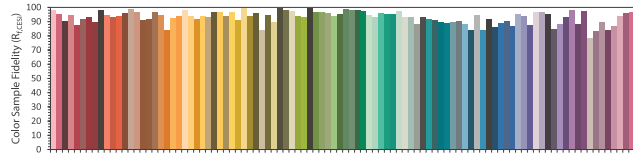

Clarté Lighting 3000K 90+ CRI Halogen Lens (H) Color Metrics

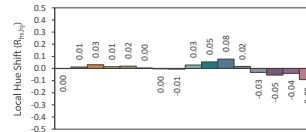
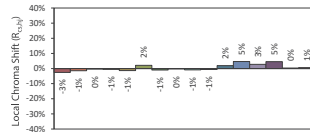
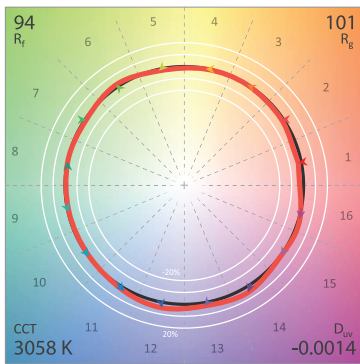

CIE 13.3-1995 (CRI)  
 $R_a$  96  
 $R_g$  79

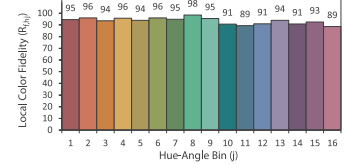
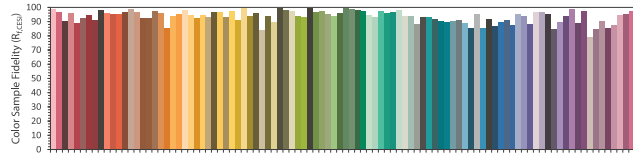

Clarté Lighting 3000K 90+ CRI Dimmed Halogen Lens (DH) Color Metrics

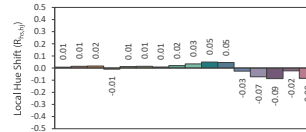
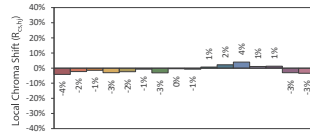
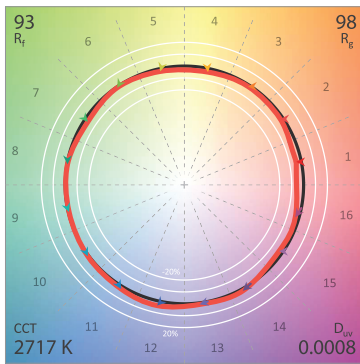

CIE 13.3-1995 (CRI)  
 $R_a$  95  
 $R_g$  64

